

Ford

THE UNIVERSAL CAR

**Prisliste over
Reservedele
og Tilbehør**

MODEL T

Ford Motor Company
Dansk Monteringsfabrik A/s
Copenhagen - Denmark

224.6

sys.nr. 1162



sys-nr. 1162

ERIK MACKEBRANG
LÆGE
4032 BJÆVERSKOV

1. AUGUST 1920

PRISERNE ER UDEN FORBINDENDE

3275
- 350

2800
- 8

2792

VIGTIGT

FORLANG at faa ÆGTE Ford Dele,
naar Deres Ford Vogn trænger til Re-
paration. — Tillad ikke at uægte eller
imiterede Dele paasættes Deres Vogn.

Ford Motor Company

FORD FABRIKER OG FILIALER

Ford Factory, Detroit—*Parent Plant*
Ford Factory, Ford Ontario, Canada
Ford Factory, Manchester, England

AMERIKANSKE EN GROS FILIALER

Atlanta	Cleveland	Fargo	Los Angeles	Oklahoma City	Salt Lake City
Boston	Columbus	Houston	Louisville	Omaha	San Francisco
Buffalo	Dallas	Indianapolis	Memphis	Philadelphia	Scranton
Charlotte	Denver	Jacksouville	Milwaukée	Pittsburgh	Seattle
Chicago	Des Moines	Kansas City, No.	Minneapolis	Portland	Washington
Cincinnati	Detroit	Long Island City	New Orleans	St. Louis	

UDENLANDSKE FILIALER OG REPARATIONSVÆRKSTEDER

Bordeaux, France	London, Eng.	Montreal, Que.	Toronto, Ont.
Buenos Aires, Argentina	London, Ontario	Paris, France	Vancouver, B. C.
Calgary, Alta.	Mnchester, Eng.	Saskatoon, Saks.	Winnipeg, Manitoba
Hamilton, Ont.	Melbourne, Aus.	St. John, N. B.	

Fremmed Afdeling—New York
Der er Ford Agenter i alle betydningsfulde Byer

Instruktioner vedrørende Bestilling af Reservedele

- 1—Bestil alle Dele gennem den nærmeste Filial eller Forhandler.
- 2—Anfør altid Katalognummer og Navn paa hver Del, der bestilles.
- 3—Brevs og Pakkepostordrer maa ledsages af et tilstrækkeligt Beløb til at dække Porto.
- 4—Alle Priser er Netto f. o. b. Filial, Fabrik eller Forhandler.
- 5—Specificer hvorledes Forsendelsen skal foretages.
- 6—Ordre paa Dele maa skrives adskilt fra Skrivelser vedrørende andre Sager.

Telegraf Kode

For at undgaa Udgifter, for hurtigt at ekspedere Ordre samt for Deres Bekvemmeligheds Skyld har vi udfærdiget et Kode Ord for hver Del af Ford Vognen, Model T. Yderligere anfører vi nedenfor en kort Almindelig Kode over forskellige Instruktioner, Spørgsmaal og Svar med Hensyn til Forsendelse af Dele.

Toperig—Send mig (os) pr. ekspres.

Toperkleur—Send pr. ekspres til _____

Topersteen—Send til mig (os) som Fragtgods.

Toper—Send til mig (os) som Pakkepost.

Topfton—Naar og hvorledes sendte De Dele bestilt i mit (vort) Telegram af _____

Topflutch—Naar og hvorledes vil De sende Dele bestilt i mit (vort) Telegram af _____

Topfwasser—Naar og hvorledes vil De sende Dele bestilt i mit (vort) Brev af _____

Indholdsfortegnelse til Prisliste over Reservedele

	Side
Afbrydere.....	30
Aksel—For.....	7
Aksel—Bag.....	5
Ammeter.....	30
Automat-Afbrydere.....	30
Batterikurve med tilhørende Dele.....	31
Bendix System.....	30
Benzinbeholder.....	9
Dynamo med tilhørende Dele.....	31
Fjedre.....	21-23
Fordele.....	13
Gear.....	16
Gearkasse.....	17
Gearregulering.....	17-19
Horn.....	34
Hjul.....	7-9
Induktionsrulle og Tændingsdele.....	30
Kalesche.....	36
Karburator.....	24
Karburatortilbehør.....	27
Karosseridele.....	21
Køler—Thermo Syphon.....	23
Lamper.....	34
Lastbildele.....	38-40
Ledninger—elektriske.....	30
Lydpotte.....	24
Magnet.....	13-16
Motor.....	12-13
Motorhjælm.....	24
Møtriker.....	33
Ramme.....	9
Startdele.....	30
Starthaandtag.....	23
Startmotor med tilhørende Dele.....	31
Skærme.....	27
Splitter.....	33
Styremekanisme.....	19
Trinbrædder og Stænkeskærme.....	27
Ventilator.....	23-24
Vindskærme.....	33
Værktøj.....	33

PRISLISTE OVER RESERVEDELE

FORD MODEL T 1909-1919

EFFECTIV 1. AUGUST 1920

Del No.	Navn paa Del	Aar	Specifikationer	Pris	Kode	Fabr. No.	Ant. pr. Vogu	Stk. pr. Vogu	Fragt Vægt
BAGAKSEL									
					Kr.				
2500	Rear axle assembly	1909-20	.56-inch tread	760	00	Aband	95E	1	
2501	Axle housing—right	1915-20		114	00	Abslove	7635C	1	
2502	Axle housing—left	1915-20		114	00	Absume	7636C	1	
2503E	Axle housing bolt and nut		$\frac{3}{16}$ " x $1\frac{1}{16}$ "	50		Ajoy	2854-44	7	
2504	Rear axle case gasket			30		Abraum	139	1	
2505	Axle shaft—tapered	1912-20	$1\frac{1}{8}$ " x $31\frac{1}{16}$ "	28	50	Abode	2818	2	8 lb.
2506	Axle shaft washer	1909-20	$1\frac{1}{32}$ " dia fibre	50		Abound	39	1	
2508	Axle shaft roller bearing	1909-20	$2\frac{13}{32}$ " x 4"	11	90	Abrase	97	4	1 lb., 3 oz.
2509	Axle shaft roller bearing sleeve—right	1909-20	4" long	2	85	Abray	170	2	.8 oz.
2509B	Axle shaft roller bearing sleeve—left	1909-20		2	85	Abate	161	2	.8 oz.
2510	Axle housing cap	1909-19	$2\frac{13}{32}$ " dia	50		Abroad	56	2	2 oz.
2510 $\frac{1}{2}$	Axle housing cap	1919-20		50		Abridge	56B	2	
2510A	Axle outer roller bearing steel washer	1909-20	$2\frac{1}{32}$ " dia	30		Absinthe	199	2	
2510B	Axle outer roller bearing felt washer	1909-20	$2\frac{7}{16}$ " dia	50		Absist	54	2	
2512C	Diff. case—left (no bushing used)	1914-20		19	00	Abut	84	1	
2513C	Diff. case—right (no bushing used)	1914-20		11	90	Ache	81	1	
2514	Diff. case stud and nut	1909-15	$\frac{3}{16}$ " x $2\frac{3}{4}$ "	95		Arcadian	52-8	3	2 oz.
2514B	Diff. case stud and nut	1915-20	$\frac{3}{16}$ " x $2\frac{3}{4}$ "	95		Ale	2865-8	3	
2518	Diff. drive gear	1909-20	40 teeth	47	50	Accost	12B	1	3 lb., 5 oz.
2519	Diff. drive gear screw	1909-20	$\frac{5}{16}$ " x $2\frac{1}{32}$ "	50		Accoy	103	10	
2519A	Diff. gear lock ring	1909-20		30		Acetic	118	2	
2520B	Diff. gear	1909-20	24 teeth	16	65	Ace	13B	2	1 lb., 6 oz.
2521B	Diff. gear key	1911-20	$1\frac{1}{8}$ " long	50		Acrid	137	2	
2524C	Diff. pinion	1915-20	12 teeth	5	70	Admire	14D	3	
2526B	Diff. spider	1909-20		9	50	Adduce	15D	1	15 oz.
2528	Diff. thrust washer	1909-20	$3\frac{3}{4}$ " dia. metal	2	85	Adieu	30	2	.6 oz.
2529	Diff. thrust plate	1909-20	$3\frac{3}{4}$ " dia. steel	2	45	Adjoin	31	4	3 oz.
2530	Diff. thrust plate pin	1909-16	$\frac{3}{16}$ " long	30		Admix	17	4	
2531	Diff. thrust plate pin	1909-16	$\frac{3}{16}$ " long	30		Adgase	37	2	
2531B	Diff. thrust plate pin	1917-20		30		Age	7640	6	
2532	Diff. housing oil plug	1909-20	$\frac{3}{8}$ " x 24 thds.	50		Agger	817	1	
2545	Rear axle grease cup	1909-20		95		Ajar	76		
2547	Rear radius rod	1909-20		33	25	Altar	152	2	4 lb., 9 oz.
2548	Radius rod nut	1909-20	$\frac{9}{16}$ " x 18 thds	55		Amass	77	2	1 oz.
2549	Radius rod lock nut	1909-20	$\frac{9}{16}$ " x 18 thds.	50		Amber	78	2	1 oz.
2550	Radius rod lock washer	1909-20	$\frac{9}{16}$ " x 18 thds.	20		Ambush	2823	2	
2551	Radius rod bolt and nut	1909-20	$\frac{1}{2}$ " x $1\frac{1}{2}$ "	95		Ampite	83-60	4	2 oz.
2557	Hub cam shaft—right	1909-20	$3\frac{1}{8}$ " long	1	90	Amuck	92B	1	3 oz.
2558	Hub cam shaft—left	1909-20	$3\frac{1}{8}$ " long	1	90	Anchor	61B	1	3 oz.
2559	Hub cam shaft bushing	1909-20	$\frac{1}{2}$ " bore, $\frac{11}{16}$ " dia.	95		Ancient	173	2	1 oz.
2562	Cam shaft lever	1909-20	$\frac{1}{2}$ " bore	1	90	Arab	62	2	2 oz.
2563	Cam shaft lever pin	1909-20	$\frac{3}{16}$ " x $7\frac{1}{8}$ "	30		Arbor	7	4	
2564	Lever clevis pin	1909-20	$\frac{3}{16}$ " x 1"	50		Arcade	65	4	
2566	Hub brake shoe	1909-20	Cast iron	3	80	Arctic	2814	2	1 lb., 9 oz.
2567	Brake shoe support bolt and nut	1909-20	$\frac{1}{2}$ " x $1\frac{1}{8}$ "	1	45	Argus	59-60	2	2 oz.
2568	Brake shoe support nut	1909-20	$\frac{1}{2}$ " x 20 thds.	50		Armor	60	2	
2570B	Brake shoe coil spring	1913-20	$3\frac{3}{8}$ " long	30		Asug	2862	4	
2571	UNIVERSAL JOINT ASSEMBLY	1909-20		23	75	Ashore	151B	1	2 lb., 12 oz.
2572	Joint knuckle (male)	1909-20		7	60	Ashust	45B	1	1 lb.
2573	Joint knuckle (female)	1909-20		9	50	Askew	46B	1	1 lb.
2574	Joint knuckle pin	1909-20	$\frac{3}{16}$ " x $1\frac{1}{2}$ "	50		Asleep	6	1	
2575	Joint ring complete	1909-20	$3\frac{1}{8}$ " dia.	9	50	Astert	49B	1	13 oz.
2576	Joint ring rivets (per set 4)	1909-20	$\frac{1}{4}$ " x $1\frac{1}{8}$ "	50		Atche	50	4	
2577	Joint housing	1909-14	$4\frac{1}{16}$ " long	19	00	Atlas	70	1	2 lb.
2577B	Univ. joint housing	1914-20		19	00	Atoll	7609	1	
2578	Joint housing plug	1909-20	$\frac{1}{2}$ " x 20 thds.	50		Atom	75	2	
2579	Ball joint grease cup	1909-20	$\frac{1}{4}$ " pipe thds.	1	45	Attic	195	1	5 oz.
2580	Ball cap gasket	1909-20		50		Auburn	1518	1	
2581	Drive shaft housing front bushing	1909-20	(1" bore), babbitt. Old. No. 2540	5	70	Balkish	69	1	5 oz.
2582	D. S. tubing	1911-20	$50\frac{3}{16}$ " long	114	00	Ballad	153D	1	
2583	D. S. roller bearing housing	1911-20	$3\frac{11}{32}$ " long	19	00	Ballot	191B	1	2 lb., 12 oz.
2584B	D. S. roller bearing stud and nut	1912-20	$1\frac{1}{32}$ " x $4\frac{5}{8}$ "	95		Balneal	183B-184	6	3 oz.
2586	D. S. roller bearing housing set screw	1911-20	$\frac{1}{2}$ " x 20 thds.	50		Banco	101	1	
2587	D. S. roller bearing	1911-20	$2\frac{5}{8}$ " long	14	25	Balsam	108	1	1 lb., 3 oz.
2588	D. S. roller bearing distance plate	1911-20	$2\frac{1}{8}$ " dia	50		Bandlet	106	1	

Forlang at faa ægte Ford Dele

570
480
1050

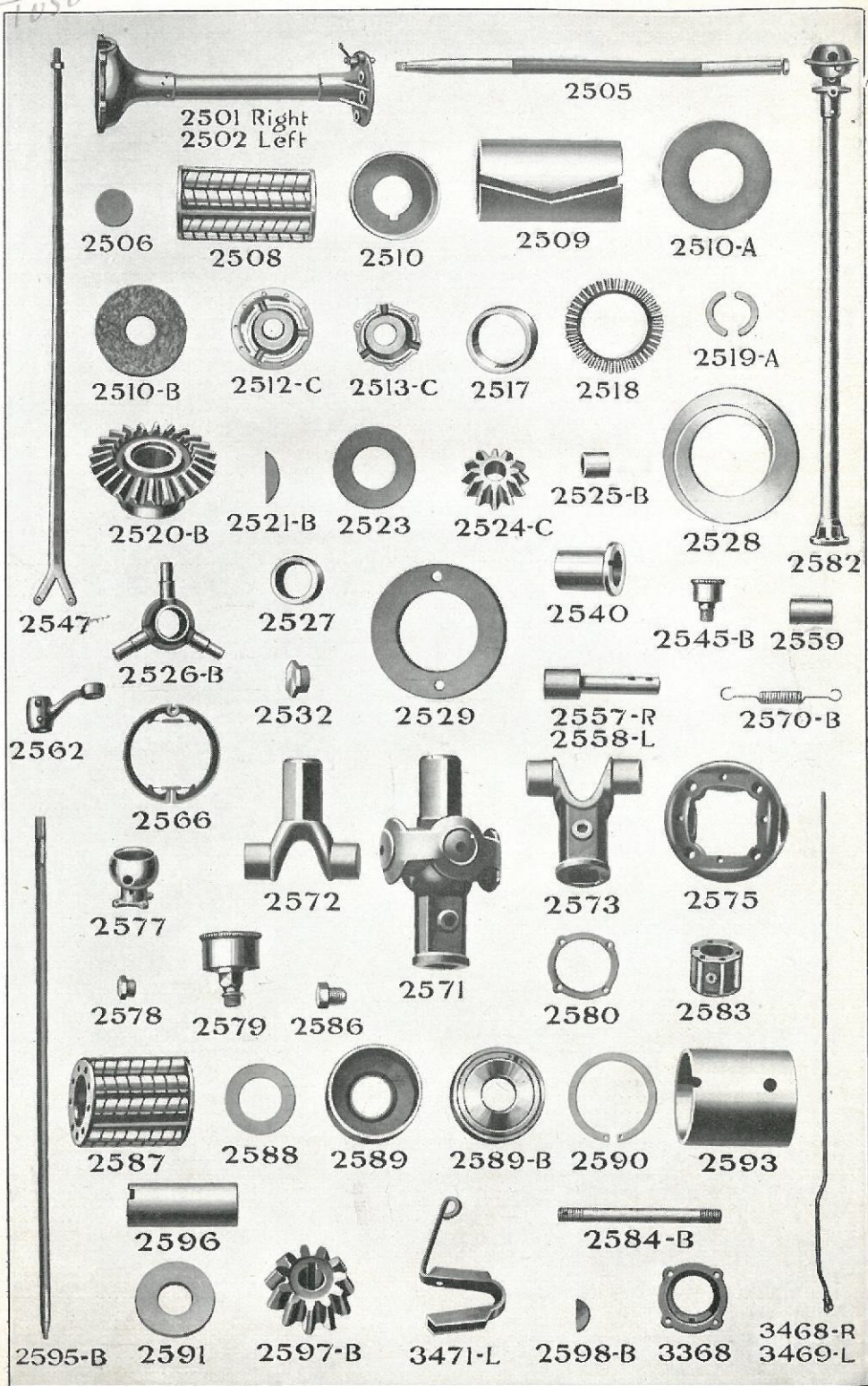

Del No.	Navn paa Del	Aar	Specifikationer	Pris	Kode	Fabr. No.	Ant. Sti. pr. Vogn	Frgt Vægt
BAGAKSEL—Fortsat				Kr.				
2589B.	D. S. ball bearing assembly	1911-20.		9 50.	Bander.	185	1	9 oz.
2589.	D. S. ball race	1911-20.	.29 ¹ / ₈ " dia.	3 35.	Bandon.	186	1	5 oz.
2590.	D. S. ball retainer	1911-20.	.21 ⁵ / ₃₂ " dia.	30.	Bandroe.	190	1	
2591.	D. S. ball thrust collar	1911-20.	.21 ¹ / ₂ " dia.	2 85.	Bandault.	188	1	3 oz.
2592.	D. S. ball bearings, each	1911-20.	Order 2811.					
2593.	D. S. roller bearing sleeve	1911-20.	.29 ¹ / ₈ " dia., 2 ⁷ / ₁₆ " long.	18 05.	Bangle.	107	1	13 oz.
2595B.	D. S. only (tapered)	1911-20.	.19 ¹ / ₃₂ " x 5 ³³ / ₁₆ "	47 50.	Banjo.	87D	1	13 lb., 8 oz.
2596.	D. S. sleeve	1911-20.	1" bore, 3 ¹ / ₁₆ " long.	11 40.	Banshee.	163B	1	6 oz.
2597B.	D. S. pinion	1911-20.	Taper bore, 11 teeth.	19 00.	Banewort	16C	1	11 oz.
2598.	D. S. castle nut	1911-20.	.6 ⁷ / ₈ " x 18 thds.	95.	Banket.	124	1	
2598B.	D. S. pinion key	1911-20.		50.	Banker.	57B	1	

BAGAKSEL—60 TOMMER SPORVIDDE

2600C.	Rear axle housing—right	1915-16.	Dia. of bell 9 ¹ / ₄ "	104 50.	Bang	2728C	1	
2601C.	Rear axle housing—left	1915-16.	Dia. of bell 9 ¹ / ₄ "	104 50.	Bard.	2729C	1	
2602B.	Rear axle shaft—tapered	1911-16.	.19 ¹ / ₃₂ " x 33 ¹ / ₁₆ "	26 15.	Baptism	2725	2	8 lb., 10 oz.
2604.	Rear radius rod	1909-16.	.53 ¹ / ₈ " tube only	38 00.	Barbett	1726	2	4 lb., 10 oz.

FORAKSEL

2690.	Front axle assembly	1909-20.	.56" tread	266 00.	Barila.	261C	1	
2691.	Front axle only	1909-20.	.56" tread	153 00.	Barber.	202B	1	
2694.	Spindle body—right	1911-19.		23 75.	Bardash	276	1	2 lb., 11 oz.
2695.	Spindle body—left	1911-19.		23 75.	Bardish	277	1	2 lb., 11 oz.
2696.	Spindle arm—right or lf.	1911-19.		7 15.	Bardism	7716	2	12 oz.
2696B.	Spindle arm—right	1911-15.	With hole for speedometer support					
2696C.	Spindle arm—right	1919.		7 15.	Bardo.	7715A	1	12 oz.
2696D.	Spindle arm—left	1919.		7 15.	Barm	7715B	1	
2697.	Spindle arm nut	1911-20.	Order 2548.	7 15.	Barry.	7716B	1	
2702.	Spindle assembly—right	1909-10.		47 50.	Barkate	205A	1	3 lb., 8 oz.
2703.	Spindle assembly—left	1909-10.		47 50.	Barker	204A	1	3 lb., 8 oz.
2704.	Stationary cone	1909-19.	.19 ¹ / ₁₆ " bore	1 90.	Barkless	205	2	4 oz.
2705.	Adjusting cone—right thread	1909-19.	.3 ¹ / ₄ " x 16 thds., R. T.	1 90.	Barley	206	1	2 oz.
2706.	Adjusting cone—left thread	1909-19.	.3 ¹ / ₄ " x 16 thds., L. T.	1 90.	Barrack	207	1	2 oz.
2707.	Spindle nut—right thread	1909-20.	.3 ¹ / ₄ " x 16 R. H. thds.	95.	Barrow	209B	1	2 oz.
2708.	Spindle nut—left thread	1909-20.	.3 ¹ / ₄ " x 16 L. H. thds.	95.	Baron	208B	1	2 oz.
2709.	Spindle washer	1909-20.	.29 ¹ / ₃₂ " hole x 1 ¹ / ₁₆ "	20.	Barras	210	2	
2710.	Spindle bolt with oiler	1910-20.	.3 ¹ / ₈ " x 6 ³ / ₁₆ "	2 40.	Barter	7708	2	7 oz.
2711.	Spindle bolt nut	1909-20.	Order 2568.					
2713.	Spindle body bush. (pair)	1909-20.	.3 ¹ / ₈ " bore	2 85.	Bartram	223	2	2 oz.
2714.	Spindle arm bushing	1909-20.	.9 ¹ / ₁₆ " bore, 1 ¹ / ₁₆ " dia., 1" L.	50.	Barwood	225	2	
2715.	Spindle oiler	1909-16.	Order 3817.					
2715C.	Spindle oiler	1917-18.		50.	Bilge	2944		
2717.	Spindle con. rod	1909-20.	.46 ³ / ₁₆ " long	23 75.	Basalt	264	1	3 lb., 2 oz.
2718.	Spindle con. rod bolt with oiler	1909-20.	.7 ¹ / ₁₆ " x 2 ¹ / ₄ "	1 90.	Basan	7706	2	3 oz.
2719.	Spindle con. rod bolt nut	1909-20.	.7 ¹ / ₁₆ " x 20 thds.	50.	Bashful	220	2	
2721.	Spindle con. rod yoke	1909-18.	.29 ¹ / ₄ " long	3 80.	Bashule	248	1	5 oz.
2721B.	Spindle con. rod yoke ball	1919-20.		2 85.	Baroko	226	1	
*2721C.	Spindle con. rod yoke	1919-20.		3 80.	Barse	248B	1	
2722.	Steering yoke clamp bolt and nut	1909-18.		75.	Barolite	79 & 8		
2725B.	Steering gear con. rod	1909-20.	Includes ball sockets	9 50.	Baslard	289	1	2 lb., 2 oz.
2728.	Ball socket cap	1909-20.		1 45.	Basent	254B	2	2 oz.
2729B.	Ball socket bolt and nut	1909-20.	Order 2722.					
2733.	Front radius rod	1909-19.		28 50.	Beardless	263	1	
2733B.	Front radius rod	1919-20.		28 50.	Bedazzle	263B	1	
2734.	Front radius rod nut	1909-20.	Order 2548.					
2736.	Front radius rod ball cap	1909-20.		1 45.	Beaufet	217	1	3 oz.
2737.	Front radius rod ball socket	1911-20.		1 90.	Beckon	809B	1	11 oz.
2741.	Radius rod ball cap stud and nut	1911-20.		50.	Berth	4365-8	2	
2742.	Radius rod ball cap spr'g	1911-20.		30.	Biecp	292	2	
2760.	FRONT AXLE ONLY	1911-16.	.60" tread	133 00.	Bechance	1720B	1	
2761.	Steering spindle con. rod	1909-16.	.60" tread	28 50.	Becket	4199	1	3 lb., 7 oz.
2762.	Steering gear con. rod	1909-16.	.60" tread, includes ball sockets	11 90.	Becloud	2739	1	

HJUL

2800.	Front wheel	1909-19.	.30" x 3"	114 00.	Becomb	291	2	
2801.	Front wheel comp. R—De-mountable.	1919-20.	Timken Bearings included, Kelsey.	142 50.	Bereave	7697	1	
2801B.	Front wheel comp. R—De-mountable.	1919-20.	Timken Bearings included, Hayes.	142 50.	Beseech	7697B	1	
2802.	Front wheel comp. L—De-mountable.	1919-20.	Timken Bearings included, Kelsey.	142 50.	Bebest	7697	1	
2802B.	Front wheel comp. L—De-mountable.	1919-20.	Timken Bearings included, Hayes.	142 50.	Betoken	7697B	1	
2803.	Front hub assembly less flange, bolts and nuts	1909-20.		33 25.	Bedew	200	2	4 lb., 9 oz.
2804.	Outer race	1909-19.	1 ¹⁹ / ₁₆ " dia.	1 45.	Bedefere	234	2	2 oz.
2805.	Inner race	1909-19.	.29 ¹ / ₃₂ "	2 40.	Bedight	235	2	5 oz.

*Naar de fornyer 2721C med en yoke af gammel Model, maa de ogsaa bestille 2721B Ball.

Forlang at faa ægte Ford Dele

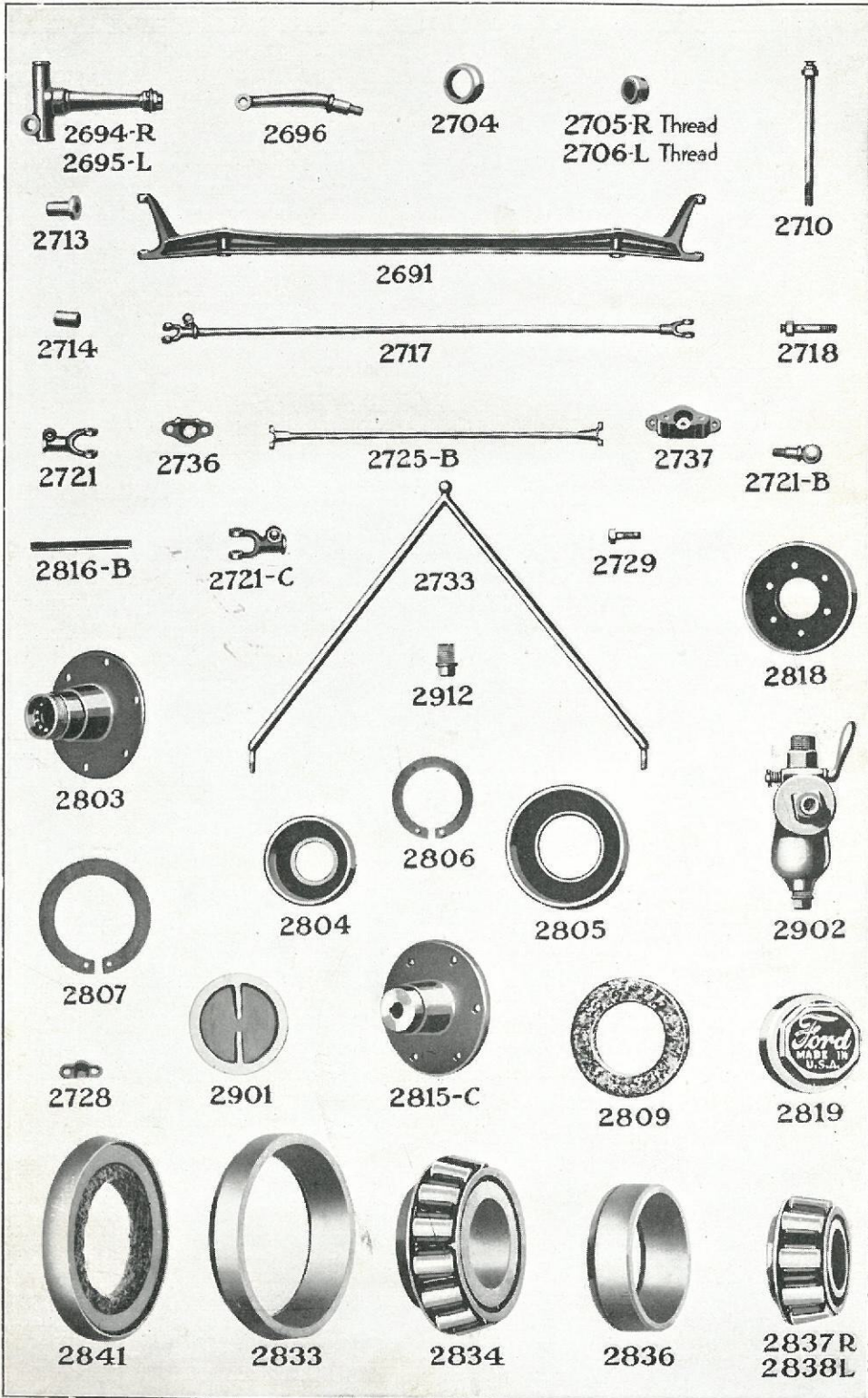

Del No.	Navn paa Del	Aar	Specifikationer	Pris	Kode Ord	Fabr. No.	Ant. Stk. pr. Vogn	Fragt Vægt
HJUL—Fortsat				Kr.				
2806	Outer ball retainer	1909-19.	1 ³⁵ / ₃₂ " dia.	20.	Bedim	236	2	
2807	Inner ball retainer	1909-19.	2 ¹⁷ / ₃₂ " dia.	30.	Bedside	237	2	
2808	Dnst ring	1909-19.	Steel 2 ²⁸ / ₃₂ " dia.	95.	Bedward	238	2	1 oz.
2809	Front and rear hub felt washer	1909-19.	2 ¹ / ₂ " dia.	50.	Bedje	239	4	
2810	Large balls, each	1909-19.	1 ¹ / ₂ "	40.	Beefing	241	24	
2811	Small balls, each	1909-19.	3 ³ / ₈ "	30.	Beemol	249	22	
2814C	Rear wheel—blue (taper hub)	1912-19.	30" x 3 ¹ / ₂ "	114 00.	Beggah	2815	2	
2814E	Rear wheel comp.	1919-20.	Demountable, Kelsey	123 50.	Begin	7698	1	
2814F	Rear wheel comp.	1919-20.	Demountable, Hayes	123 50.	Behoney	7698B	1	
2815C	REAR HUB (TAPERED) less flange bolts & nuts	1912-20.		23 75.	Begol	2819	2	4 lb., 3 oz.
2816B	Rear hub key	1912-20.	1 ¹ / ₂ " x 1 ¹ / ₂ " x 2 ¹¹ / ₃₂ "	50.	Begloom	2863	2	1 oz.
2818	Rear hub brake drum	1909-20.	3" hole, 8" dia.	6 65.	Beguiler	3	2	2 lb., 9 oz.
2819	Hub cap	1909-20.	2 ¹ / ₂ " x 24 thds.	1 90.	Behave	7727	2	3 oz.
2825	Hub bolt and nut	1911-20.	8 ¹ / ₈ " x 2 ¹ / ₈ " x 16 thds.	50.	Belay	28B-29	4	
2827	Hub flange	1911-20.	6" dia.	2 85.	Bellow	235B	4	1 lb., 5 oz.
2828	Rear hub lock nut	1912-20.	3 ³ / ₈ " x 18 thds.	95.	Bengal	242	2	2 oz.
2831	Timken bearing assembly inner and outer R. including dust ring (in carton)	1919-20.		38 00.	Bemix	2961	1	
2832	Timken bearing assembly inner and outer L. including dust ring (in carton)	1919-20.		38 00.	Ben	2962	1	
2833	Front hub bearing cup inner	1919-20.		7 60.	Benip	2955	2	
2834	Inside spindle cone and roller assembly	1919-20.		12 35.	Bent	205B	2	
2835	Front hub bearing assembly inner (less dust ring)	1919-20.		17 60.	Bemusk	2954	2	
2836	Front hub bearing cup outer	1919-20.		6 65.	Bepad	2956	2	
2837	Outside spindle cone and roller assembly R.	1919-20.		9 50.	Beplay	206B	1	
2838	Outside spindle cone and roller assembly L.	1919-20.		9 50.	Beplume	207B	1	
2839	Front hub bearing assembly outer R.	1919-20.		13 80.	Berot	351	1	
2840	Front hub bearing assembly outer L.	1916-20.		13 80.	Beset	352	1	
2841	Front hub dust cap assembly	1919-20.		1 90.	Besunk	350	2	
2845	Demountable rim only	1919-20.	Kelsey	28 50.	Bethrone	8774	4	
2845B	Demountable rim only	1919-20.	Hayes	28 50.	Bejape	8774E	4	
2846	Demountable rim clamp	1919-20.	Kelsey	1 45.	Betimec	8831	16	
2847	Demountable rim bolt	1919-20.		95.	Bewax	8832	16	
2848	Demountable rim bolt nut	1919-20.	Hayes	50.	Benison	8x34B	4	
2848B	Demountable rim bolt nut	1919-20.	Kelsey	50.	Belabor	8834	4	
2849	Spare rim carrier	1919.		47 50.	Belamy	8848	1	

RAMME

2850	Frame assembly	1909-20.		152 00.	Belone	2916	1	
2851B	Side member—right	1914-20.		47 50.	Benign	2914	1	
2852B	Side member—left	1914-20.		47 50.	Berdash	2915	1	
2853	Front cross member	1909-20.	22 ²⁹ / ₃₂ " long	13 50.	Beluga	303	1	3 lb., 15 oz.
2854B	Rear cross member	1914-20.		15 20.	Bendlet	2913	1	7 lb., 8 oz.
2855	Front corner bracket—right	1909-20.		1 90.	Benumb	305	1	8 oz.
2856	Front corner bracket—left	1909-20.		1 90.	Bequest	306	1	8 oz.
2857	Rear corner bracket—right	1909-20.		1 90.	Besiege	307	1	9 oz.
2858	Rear corner bracket—left	1909-20.		1 90.	Bespawl	308	1	9 oz.
2859	Frame front end spacer—left	1917-20.		95.	Benzoine	318B		
2860	Frame front end spacer—right	1917-20.		95.	Bestial	319B		
2863	Body bracket	1909-20.	On frame	1 45.	Bestow	344	4	4 oz.

BENZINBEHOLDER—TOURING« VOGN

2900	Gasoline tank	1909-20.	10 gallons	38 00.	Bibber	1303	1	
2900B	Gas tank	1916-20.	Sedan	66 50.	Binocle	7950		
2900C	Gasoline tank	1920.	Elliptical	47 50.	Biacid	1303B	1	
2901	Filling plug	1909-20.	2 ¹ / ₈ "	95.	Biblist	1317	1	1 oz.
2902B	Sediment bulb	1909-20.	Less pet cock	9 50.	Bickers	2088	1	1 lb., 2 oz.
2908	Pet cock	1909-20.	Order 3079					
2909	Feed pipe	1909-20.	Touring and Runabout, Also Coupe, 1915-17.	4 75.	Billet	1364	1	4 oz.
2910	Feed pipe pack nut	1909-20.	1 ¹ / ₂ " x 18 thds.	50.	Bilow	1374	2	
2909B	Feed pipe	1916-20.	Sedan	5 70.	Bismuth	7965		
2909C	Feed pipe	1918-19.	Couplet	7 15.	Bisque	9775		
2909D	Feed pipe	1919-20.	Coupe	6 20.	Betray	8690	1	
2911	Feed pipe	1915.	Sedan, 78" long	9 50.	Betrap	1394	1	
2912	Sediment plug		Obsolete—Sub. with 3079					
2913	Feed pipe gasket	1909-20.		20.	Fester	5892	1	

Forlang at faa ægte Ford Dele



3001

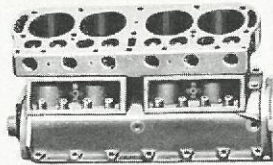

3000



3002

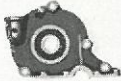

3009 B

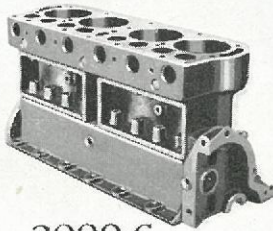

3000-C



3009-C



3017



3013



3084

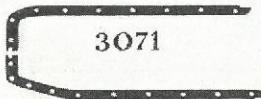

3071



3101 B

3070



3085



3101

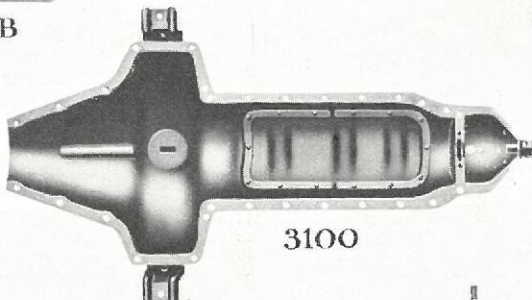

3100



3102



3110



3111



3112



3165



3163



3176

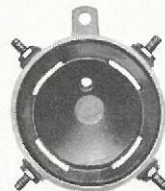

3221



3012

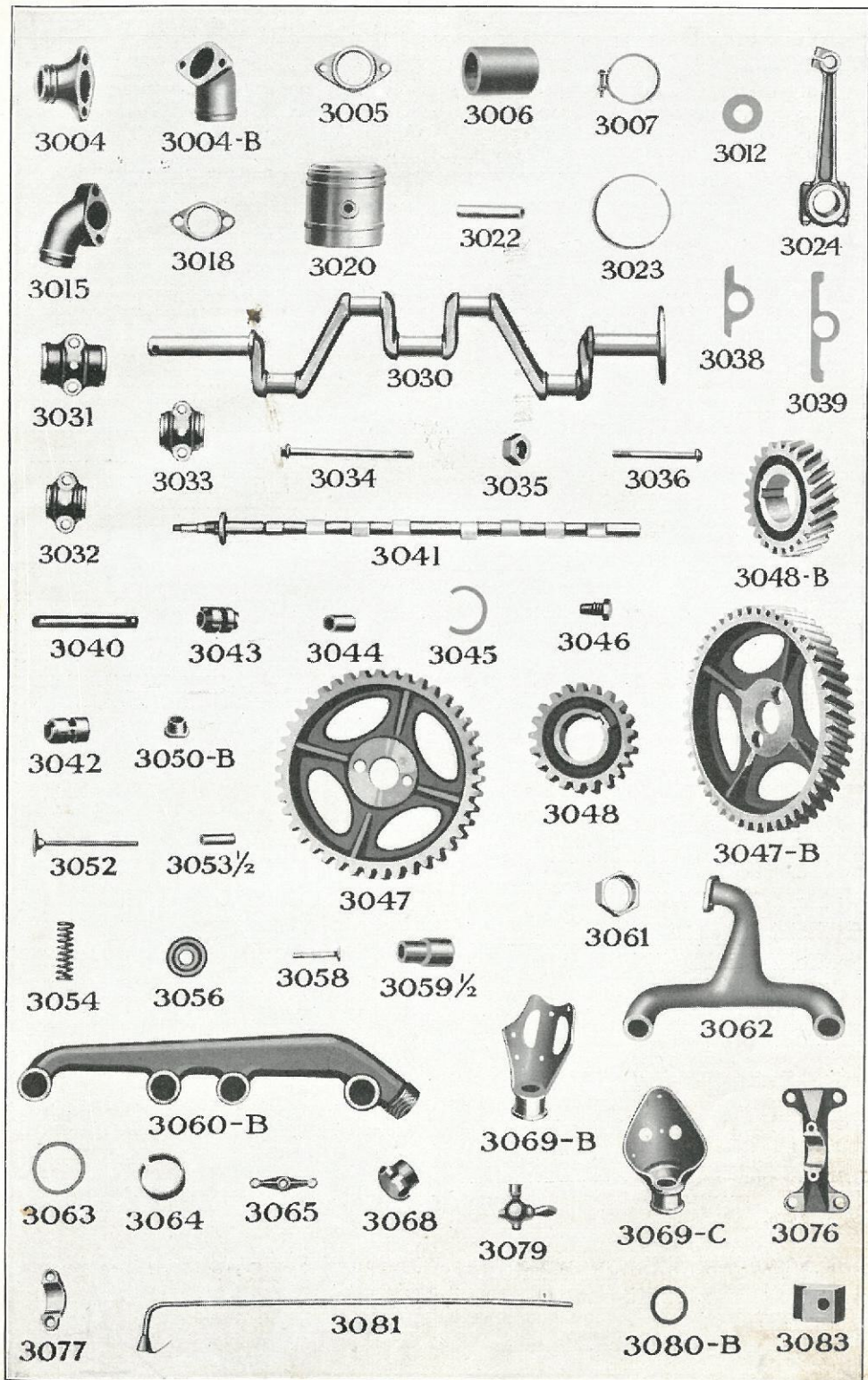

Del No.	Navn paa Del	Aar	Specifikationer	Pris	Kode Ord	Fabr. No.	Ant. Stk. pr. Vogn	Fragt Vægt
MOTOR				Kr.				
x3000C.	Cylinder	1919-20.	Starter type	332 50.	Calcox	400D	1
3001.	Cylinder head	1909-20.		76 00.	Cabin	401C	1
3002.	Cyl. head gasket	1909-20.		4 75.	Caboose	402B	1 5 oz.
3003.	Cyl. head cap screw	1909-20.	$7/16'' \times 2\frac{1}{32}''$	50.	Cackle	483B	15 2 oz.
3003B.	Cyl. head cap screw	1918-20.	$7/16'' \times 3\frac{1}{4}''$	50.	Chub	483C	1
3004.	Cyl. head outlet connect.	1909-16.	Cast iron	3 35.	Caddow	446C	1 11 oz.
3004B.	Cyl. head outlet connection	1917-20.		3 35.	Canis	8719	1
3005.	Cyl. head outlet connection gasket	1909-20.		50.	Caddy	445B	1
3006.	Cyl. head outlet hose	1909-20.	2'' x 4''	2 85.	Cadet	448B	1 4 oz.
3007.	Cyl. head outlet hose clip	1909-20.	$2\frac{1}{8}''$ dia.	50.	Cadger	607B	2 1 oz.
3008.	Cyl. head outlet connection screw	1909-20.	$7/16'' \times 1\frac{15}{16}''$	50.	Cadmean	550C	2 1 oz.
3009B.	Cyl. front cover	1909-19.		14 25.	Cage	690B	1	2 lb., 1 oz.
3009C.	Cyl. front cover	1919-20.	Starter type	14 25.	Canard	690C	1
3010.	Cyl. cover bolt and nut	1909-20.	$3/8'' \times 1\frac{1}{2}''$, Order 4808					
3011.	Cyl. cover cap screw	1909-20.	$3/8'' \times 1\frac{1}{16}''$	50.	Cahoot	432	3
3012.	Cyl. cover felt	1909-20.	Felt	50.	Caitiff	504	1
3013.	Cyl. cover liner	1909-19.	Paper	20.	Cajole	505B	1
3013B.	Cyl. cover liner	1919-20.	Paper—starter type	30.	Cajom	505C	1
3014.	Cyl. cover and crank case bolt and nut	1909-20.	$8/16'' \times 1\frac{1}{8}''$, Order 2722					
3015.	Cyl. water inlet connection	1909-20.	Cast iron	3 35.	Calcine	442B	1	1 lb., 3 oz.
3016.	Cyl. inlet con. screw	1909-20.	$7/16'' \times 1\frac{1}{8}''$	50.	Caldron	597	2
3017.	Time gear cover	1919-20.	Starter type	14 25.	Calico	1754	1
3017B.	Time gear cover	1919-20.		9 50.	Callix	1769	1
3017C.	Time gear cover gasket	1919-20.	Old No. 4912	20.	Candid	1775	1
3017D.	Time gear cover plate	1919-20.	Old No. 4922	95.	Camine	1773	1
3018.	Cyl. water inlet gasket	1909-19.	Copper	50.	Calefy	596	1
3019.	Cyl. water jacket plug	1909-15.	$1/2''$ pipe plug	50.	Capin	557	3 1 oz.
3019B.	Cyl. water jacket plug	1914-20.		20.	Canon	5919	3
3020.	PISTON COMPLETE	1909-20.	$3/8''$ dia.	26 60.	Caliph	586C	4	3 lb., 9 oz.
3020C.	PISTON COMPLETE	1909-20.	.0025" oversize	26 60.	Canopy	683A	4
3020D.	PISTON COMPLETE	1909-20.	.03125" oversize	26 60.	Capon	683C	4
3020E.	PISTON COMPLETE	1909-20.	.033" oversize	26 60.	Chum	683B	4
3021.	Piston only	1909-20.	$3/8''$ dia.	19 00.	Callous	4472	4
3021B.	Piston only	1909-20.	.0025" oversize	19 00.	Chopin	5999	4
3021C.	Piston only	1909-20.	.03125 oversize	19 00.	Chord	5918	4
3021D.	Piston only	1909-20.	.033" oversize	19 00.	Chute	5901	4
3022.	Piston pin	1909-20.		3 35.	Callot	419B	4 4 oz.
3022 ^{1/2} .	Piston pin bushing (pair)	1909-20.		3 35.	Callow	668	4 3 oz.
3023.	Piston ring	1909-20.	$1\frac{1}{2}'' \times 3\frac{1}{16}''$	1 45.	Calmy	422	12 2 oz.
3023B.	Piston ring	1909-20.	.03125" oversize	1 45.	Calf	5917	12
3024.	CONNECTING ROD	1909-20.	Includes bearings	19 00.	Calvish	641	4	1 lb., 9 oz.
3025.	Con. rod cap bolt and nut	1909-20.	$3/8'' \times 2'' \times 24$ thds.	95.	Calyz	489B-490	8
3029.	Con. rod clamp screw	1909-20.	$3/16'' \times 1\frac{1}{16}''$	60.	Cambrie	578	4
3030.	CRANK SHAFT	1909-20.	$2\frac{5}{16}''$ long	142 50.	Camel	498B	1
3031.	C. S. Rear bearing cap	1909-20.	$3/16''$ long, babbitted	8 55.	Camen	405B	1	1 lb., 1 oz.
3032.	C. S. front bearing cap	1909-20.	$1\frac{1}{16}''$ long, babbitted	6 20.	Camera	406B	1 10 oz.
3033.	C. S. center bearing cap	1909-20.	$2\frac{1}{32}''$ long, babbitted	6 20.	Camlet	407B	1 10 oz.
3034.	C. S. bearing bolt—center and front	1909-20.	$1/2'' \times 6\frac{1}{16}'' \times 20$ thds.	1 90.	Camphor	408	4 6 oz.
3035.	C. S. bearing bolt nut	1909-20.	Order 2568					
3036.	C. S. rear bearing bolt	1909-20.	$1/2'' \times 4\frac{1}{32}''$	1 45.	Candle	478	2 4 oz.
3038.	C. S. bearing liner—center and front	1909-20.	$1\frac{15}{16}''$ long, brass	10.	Cannon	502B	8
3039.	C. S. rear bearing liner	1909-20.	3" long, brass	10.	Canny	503B	4
3040.	C. S. starting pin	1909-20.	$3/8'' \times 2\frac{1}{16}''$	50.	Canoe	529B	1 2 oz.
3041.	CAM SHAFT	1909-20.		57 00.	Canteen	410	1	3 lb., 4 oz.
3042.	Cam shaft front bearing	1909-20.	2" long	5 70.	Canter	411	1 6 oz.
3043.	Cam shaft center bearing	1909-20.	$2\frac{1}{8}''$ long	3 35.	Canthus	412B	1 6 oz.
3044.	Cam shaft rear bearing	1909-20.	Bronze, $1\frac{1}{16}''$ long	1 90.	Canto	413	1 3 oz.
3045.	Cam shaft bearing ring	1909-20.	$3/16'' \times 1\frac{1}{16}''$	50.	Canvas	534	2
3046.	Cam shaft bear'g set screw	1909-20.	$7/32'' \times 6\frac{1}{4}''$	50.	Capelin	414	2
+3047.	Timegear—large (on cam shaft)	1909-19.	42 teeth	11 90.	Caper	415	1	1 lb., 10 oz.
3047B.	Timegear—large (on cam shaft)	1919-20.	Spiral	14 25.	Clang	415B	1
+3048.	Time gear—small (on crank shaft)	1909-19.	21 teeth	9 50.	Capat	416	1 11 oz.
3048B.	Time gear—small (on crank shaft)	1919-20.	Spiral	11 90.	Claret	416B	1
3049.	Cam shaft gear dowel pin	1909-20.	$3/16'' \times 7/16''$	50.	Capra	417	2
3050B.	Cam shaft gear lock nut	1909-20.		1 90.	Captive	4453	1 2 oz.
3051.	Small time gear key	1909-20.		50.	Capsize	477	1
3052.	Valve	1909-20.	Exhaust and inlet	1 90.	Capstan	424	8 3 oz.
3052B.	Valve	1909-20.	$1/16''$ oversize stem	1 90.	Cake	5913	8
3053 ^{1/2} .	Valve bushing	1909-20.	$3/16''$ O. D. x 2" long	2 85.	Captain	428	8 2 oz.
3054.	Valve spring	1909-20.		50.	Capture	431	8 1 oz.
3056.	Valve spring seat	1909-20.	$1\frac{1}{8}''$ dia.	50.	Carack	425	8

xNaar brugt paa Vogn ikke forsynet med Starter bestil ogsaa 3017B, 3017, 3011, 3008 og 3016.

zAnvendes med 3000C Cylinder paa Vogne ikke forsynede med Starters.

*Plejestænger, der trænger til nye Lejer, kan ombyttes paa Pihjal eller Fabrik for en rimelig Pris.

+Erstat med Spinalhjul, naar gammel Model Knastaskenhjul fornyes.

Forlang at faa ægte Ford Dele

Del No.	Navn paa Del	Aar	Specifikationer	Pris	Kode Ord	Fabr. No	Ant. pr. Vogn	Stik. Vogn	Frngt Vægt
MOTOR—Fortsat				Kr.					
3057	Valve spring seat pin	1909-20	$\frac{7}{64}$ " x $\frac{17}{32}$ "	53	Caranx	429	8		
3058	Push rod	1909-20	$\frac{7}{16}$ " dia., $2\frac{11}{32}$ "	1 45	Carat	426	8		2 oz.
3058B	Push rod	1909-20	$\frac{7}{16}$ " oversize stem	1 45	Cantata	3914	8		
3059 $\frac{1}{2}$	Push rod bushing	1909-20	Iron	2 85	Chippy	427B	8		2 oz.
3060B	Exhaust manifold	1913-20	Iron	19 00	Chirp	4483	1	4 lb.	8 oz.
3061	Exhaust pipe pack nut	1909-20	$\frac{17}{16}$ " x 18 thds.	2 85	Chitter	518	1		4 oz.
3062	Inlet pipe	1909-20		16 65	Chloris	512B	1	2 lb.	8 oz.
3063	Inlet and exh't pipe gask't.	1909-20	$\frac{13}{16}$ " O. D. copper	30	Choker	513	6		1 oz.
3064	Inlet and exhaust pipe gland	1909-20	$\frac{13}{16}$ " dia., iron	30	Chopper	514	6		
3065	Inlet and exhaust pipe clamp	1909-20	$2\frac{29}{32}$ " long	1 45	Choral	515	4		3 oz.
3066	Inlet and exhaust clamp stud and nut	1909-20	$\frac{8}{16}$ " x $\frac{3}{4}$ "	95	Chorus	516-517	4		2 oz.
3068	Breather pipe	1909-20	$1\frac{15}{16}$ " long	95	Chuck	4468	1		2 oz.
3069B	Crank case front end sup. port	1911-17		9 50	Clam	801C	1		
3069C	Crank case front end sup. port	1917-20		9 50	Clack	801D	1		
3070B	Cr. case & cyl. gasket—left	1909-20	Cork	95	Cider	886	1		
3071B	Cr. c. & cyl. gasket—right	1909-20	Cork	95	Cigar	887	1		
3072	Crank case and cyl. cover cap screw	1909-20	$\frac{3}{16}$ " x 1"	95	Cinter	1388	2		
3073	Crank case arm bolt and nut—side	1909-20	$\frac{8}{16}$ " x $2\frac{1}{4}$ "	95	Cippers	479-8	2		2 oz.
3074	Crank case arm bolt and nut top	1909-20	$\frac{8}{16}$ " x $2\frac{5}{16}$ "	95	Cirdlet	940-8	2		
3076	Crank case front frame bearing	1909-20	Iron	5 70	Circus	320B	1	1 lb.	6 oz.
3077	Crank case front bearing cap	1909-20	Iron	2 85	Cizar	321	1		3 oz.
3078	Crank case front bearing screw	1909-20	$\frac{7}{16}$ " x $\frac{7}{16}$ "	50	Clabber	322	2		1 oz.
3079	Crank case oil cock	1909-20		2 40	Clamber	1515	2		2 oz.
3080	Crank case drain cup plug	1909-20	Order 2532						
3080B	Crank case drain cup plug gasket	1909-20		30	Cliff	4339	1		
3081	Crank case oil tube	1909-20		2 85	Cleavast	543B	1		2 oz.
3083	Crank case oil block	1909-20	Wood	50	Cergy	890	2		3 oz.
3083B	Crank case arm block	1918-20	Truck—Old No. 1127	50	Grape	TT890	2		
3084	Engine pan—right	1909-20		3 80	Clicket	1350B	1	1 lb.	14 oz.
3085	Engine pan—left	1909-20		3 80	Clientage	1351B	1	1 lb.	11 oz.
3088B	Engine pan and hood board bolt and nut	1909-20	$\frac{1}{4}$ " x $3\frac{1}{4}$ "	50	Clog	4074-1309	2		
3088C	Engine pan and hood board bolt and nut	1909-20	$\frac{1}{4}$ " x $3\frac{5}{8}$ "	50	Clod	4073-1309	2		
3088D	Engine pan and hood board bolt and nut	1918-20	Truck—Old No. 1128	50	Guest	TT4073-T1309	2		
3100	CRANK CASE WITH LOWER COVER	1912-20		152 00	Closet	1526E	1		
3101	Crank case lower cover	1912-20	$\frac{67}{16}$ " x $15\frac{1}{2}$ "	4 75	Closure	1582	1	2 lb.	13 oz.
3101B	Crank case lower cover reinforcement	1912-20		4 30	Clothes	4378-4379	1	1 lb.	11 oz.
3102B	Cr. c. lower cover gasket	1912-20	Cork	95	Clotting	1586	1		
3103	Crank case lower cover screw	1912-20	$\frac{7}{16}$ " x $\frac{7}{16}$ "	50	Cloudlet	4328	14		
3110	Cylinder valve cover	1912-20	$\frac{39}{16}$ " x 8"	1 45	Clovate	656	2		9 oz.
3111B	Cyl. valve cover gasket	1912-20	Cork	50	Cloven	660	2		
3112	Cyl. valve cover screw	1912-20	$\frac{3}{16}$ " x $2\frac{29}{32}$ "	95	Compone	654	2		2 oz.
3114	Crank case arm with rivets	1909-20		3 35	Cloth	815	2		

FORDELE

3162	Com. case support bolt	1912-19	$\frac{8}{16}$ " x $2\frac{1}{4}$ " x 24 thds.	50	Connote	4441	1		2 oz.
3162B	Com. case support bolt	1919-20	Starter type	65	Constrict	1756	1		
3163	Com. case spring	1912-20	$\frac{3}{16}$ " C. to C.	50	Conoid	689	1		1 oz.
3165	Com. brush only	1912-20		4 75	Conquest	4481	1		
3176	Com. oiler	1912-16	$\frac{1}{16}$ " pipe thds.	50	Coomb	2385	1		
3176B	Com. oiler	1917-20		50	Coot	480	1		
3176C	Com. oiler	1919-20		50	Cookee	480B	1		
3177	Com. felt ring	1912-20	Felt	30	Coombbox	5930	1		
3206	Com. brush cap	1909-20	$\frac{7}{16}$ " dia.	30	Convert	468	1		
3207	Com. brush cap pin	1909-20	$\frac{3}{16}$ " x $\frac{18}{16}$ "	20	Convict	466	1		
3210	Com. contact point nut	1910-20	$\frac{7}{16}$ " hex.	20	Cooper	472B	8		
3212	Com. thumb nut	1909-17	No. 10, 32 thds.	50	Copeck	6764	4		
3220	Com. lock nut	1909-20	$\frac{3}{16}$ " x 18 thds.	50	Crater	471	1		
3221	Com. case with fibre assembled	1912-20		11 40	Crato	5908	1		
3222	Com. shield	1912-20		30	Crash	5923	1		

MAGNET

3250D	Magneto coil assembly	1915-20	Used with $\frac{8}{16}$ " magnets.	76 00	Craft	5941B	1		
3252	Magneto spool support screw	1909-20	Order 3371						

Forlang at faa ægte Ford Dele

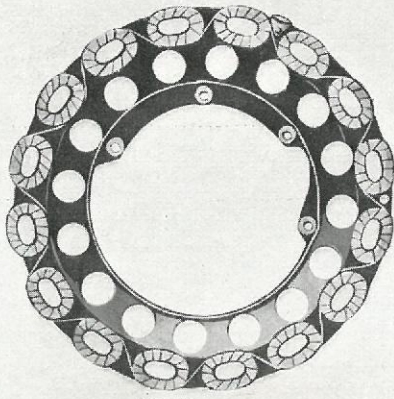

3250-D



3254

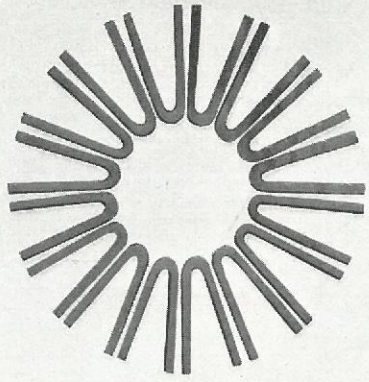

3276-B



3260

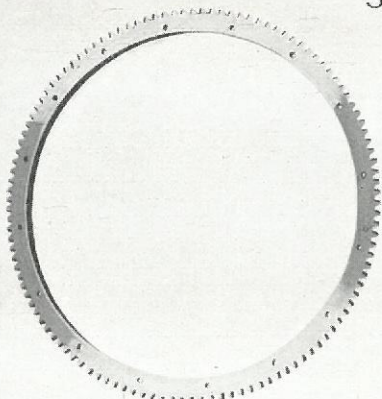

3268



3277



3257



3277-B



3270



3278



3255-B



3272

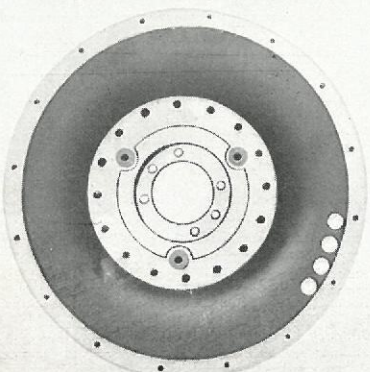

3269-C



3279

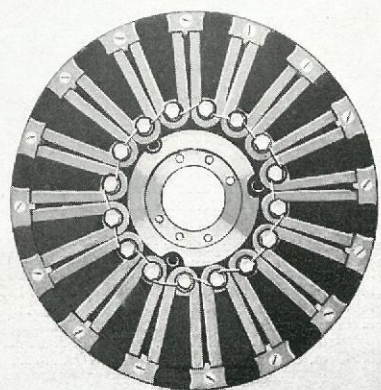

3269-E

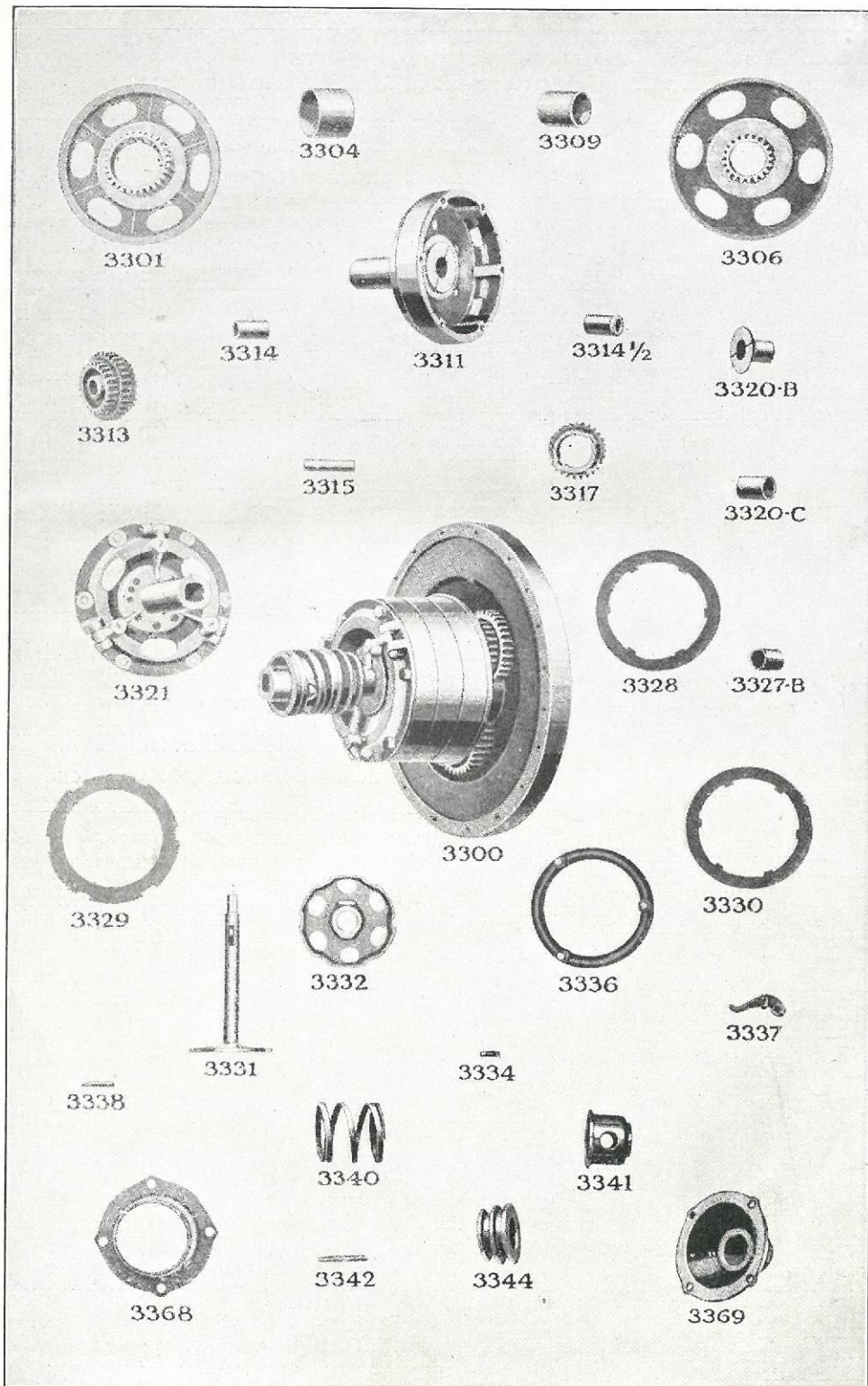

Del No.	Navn paa Del	Aar	Specifikationer	Pris	Kode Ord	Fabr. No.	Ant. Stk. pr. Vogt	Fragt Vægt
MAGNET—Fortsat				Kr.				
3254	Magnet bolt	1909-20	$\frac{3}{16}'' \times 1\frac{1}{8}''$	50.	Corbeil	537B	16	1 oz.
3255B	Magnet bolt washer	1911-20	$\frac{25}{64}''$ hole, $\frac{7}{8}''$ dia	20.	Corrupt	624	16	
3257	Magnet brass support	1909-20	$\frac{5}{16}'' \times \frac{3}{8}''$, brass	50.	Cordial	535C	16	
3260	Magneto con. assembly	1909-20	On trans. cover	3 35.	Cornus	1545	1	2 oz.
3261B	Magneto contact nut	1909-20		10.	Cornute	1508	2	
3261C	Magneto contact screw washer	1909-20		10.	Cornel	1565		
3262	Magneto contact spring	1909-20	Coil spring	50.	Cornise	1509	1	
3262B	Magneto contact screw and spring assb.	1919-20		95.	Corsage	4350		
3266	Magneto contact fibre screw	1909-20	$\frac{1}{8}''$ long	10.	Cortile	1505B	3	
3267	Magneto primary insulating block	1915-20		50.	Crumple	4382		
3267B	Magneto contact insulator	1919-20		95.	Crush	1503B		
3267C	Magneto contact insulator shell	1919-20		30.	Crutch	8611		
3268	Fly wheel ring gear	1919-20	For starter	33 25.	Cousin	1885	1	
3269C	Fly wheel	1911-19		61 75.	Cosmic	701B	1	
3269E	Fly wheel with magnets assembled	1915-19	$\frac{3}{4}''$ magnets	142 50.	Cramp	5946	1	
3269G	Fly wheel only	1919-20	Starter type	61 75.	Cozy	701C	1	
3270	Fly wheel cap screw	1909-20	$\frac{7}{16}'' \times 1\frac{1}{16}''$	1 45.	Cossack	721	2	2 oz.
3271	Fly wheel dowel pin	1909-20	$\frac{15}{64}'' \times 1\frac{1}{16}''$	60.	Costard	722	2	
3272	Magneto coil support shim	1909-20	Sheet steel	95.	Costrel	584	1	
3276B	Magnet (16) per set	1915-20	$\frac{3}{16}''$ set	66 50.	Court	5933	16	
3277	Magnet clamp	1911-20		50.	Cotland	623	16	
3277B	Magnet clamp	1913-14		95.	Cotta	4499	16	
3278	Magnet clamp screw	1911-20	$\frac{29}{64}'' \times 24$ thds., brass	50.	Cottage	625	16	
3279	Magneto-contact washer	1909-20	On trans. cover cork	30.	Cough	560	1	
GEAR								
3300B	Transmission assembly	1919-20	Starter type. Does not include gear or magnets	475 00.	Daciam	744C		
3301	Trans. reverse plate assembly	1909-20		38 00.	Dacolt	747	1	4 lb., 14 oz.
3304	Trans. reverse gear bushing	1909-20	$\frac{25}{16}''$ rear	6 65.	Daddy	705	1	9 oz.
3305	Trans. reverse and S. S. rivet	1909-20	$\frac{7}{32}'' \times 1\frac{1}{16}''$ per doz.	50.	Dado	708	8	
3306	TRANS. SLOW SPEED PLATE ASSEMBLY	1909-20		35 25.	Dagger	748	1	4 lb., 8 oz.
3309	Trans. slow speed gear bushing	1909-20	$1\frac{31}{32}''$ ream	5 70.	Dairy	745	1	5 oz.
3310	Trans. brake drum rivet	1909-20	$\frac{7}{32}'' \times 1\frac{1}{16}''$ per doz.	50.	Daisy	711	8	
3311	TRANS. BRAKE DRUM ASSEMBLY	1909-20		42 75.	Dakin	750	1	6 lb., 2 oz.
3313	TRANS. TRIPLE GEAR ASSEMBLY	1909-20		28 50.	Dallop	751B	3	2 lb.
3314 ^{1/2}	Trans. triple gear flanged bushing	1911-20	$1\frac{13}{16}''$ dia. x $1\frac{39}{64}''$	3 80.	Dalriad	716B	3	4 oz.
3315	Trans. triple gear shaft	1909-20	$\frac{13}{16}''$ dia. x $2\frac{1}{8}''$	2 40.	Dalrotz	715	3	4 oz.
3316	Trans. triple gear riveting pin	1909-20	$\frac{3}{16}'' \times 1\frac{1}{16}''$ per doz.	50.	Damar	720	24	
3317	Trans. driven gear	1909-20	27 teeth	11 90.	Damask	713	1	13 oz.
3318	Trans. driven gear key	1909-20		50.	Dampen	714	2	4 oz.
3320B	Trans. driven gear sleeve bushing	1909-20	1" ream x flange $2\frac{3}{8}''$	5 70.	Dankish	769R	1	4 oz.
3320C	Trans. driven gear sleeve bushing	1909-20	$1\frac{1}{2}''$ long	3 55.	Dark	712	2	3 oz.
3320D	Driven gear sleeve washer	1909-20		30.	Darken	776	3	
3321	TRANS. DRIVING PLATE ASSEMBLY	1909-20		47 50.	Dannock	749	1	5 lb.
3323	Trans. driving plate screw	1909-20	Order 3371					
3325	Trans. driving plate rivet	1909-20	$\frac{1}{8}'' \times \frac{5}{8}''$ per doz.	50.	Darner	736	8	
3327B	Trans. driving plate bushing	1909-20	$1\frac{1}{2}'' \times 1\frac{1}{4}''$	2 85.	Darsis	722	1	
3328	Trans. thrust plate—small	1909-20	.6" dia.	1 45.	Dauphin	727	12	3 oz.
3329	Trans. thrust plate—large	1909-20	$\frac{67}{16}''$ O. D.	1 90.	Davine	728	13	5 oz.
3330	Trans. distance plate	1909-16	.6" O. D.	2 85.	Decry	729	1	7 oz.
3331	Trans. gear shaft	1909-20	1" dia. x $7\frac{1}{2}''$ over all.	25 75.	Decurt	723B	1	2 lb., 10 oz.
3332	Trans. clutch disc drum	1909-20	$\frac{49}{16}''$ dia.	25 75.	Deeply	725B	1	1 lb., 11 oz.
3333	Trans. clutch disc drum key	1909-20		50.	Defalk	726B	1	
3334	Trans. clutch disc drum set screw	1909-20	$\frac{3}{16}'' \times \frac{3}{4}''$	60.	Defeat	752	1	
3336	Trans. clutch push ring	1909-20	$\frac{67}{16}''$ O. D.	4 75.	Defile	770	1	1 lb., 1 oz.
3337	Trans. clutch finger	1909-20		2 40.	Define	732	3	5 oz.
3337 ^{1/2}	Trans. clutch finger screw	1909-20	$\frac{3}{16}'' \times \frac{3}{16}'' \times 24$ thds.	50.	Defleur	756	3	
3338	Trans. clutch finger pin	1909-20	$\frac{11}{16}'' \times 1\frac{3}{8}''$	20.	Deform	735	3	1 oz.
3340	Trans. clutch spring	1909-20	$\frac{25}{16}''$ dia. x $2\frac{3}{4}''$ long	3 80.	Defoue	737	1	10 oz.
3341	Trans. clutch spring support	1909-20		1 45.	Delator	738	1	4 oz.
3342	Trans. clutch spring thrust ring pin	1909-20	$\frac{5}{16}'' \times 2\frac{3}{8}''$	50.	Delete	739	1	
3344	Trans. clutch shift	1909-20		9 50.	Delight	733	1	14 oz.

*Naar der bruges kort Bøsning ved Reparation, fjern da Drivflangens Kile.

Forlang at faa ægte Ford Dele

Del No.	Navn paa Del	Aar	Specifikationer	Pris	Kode Ord	Fabr. No.	Ant. Stk. pr. Vogn	Fragt Vægt
GEARKASSE				Kr.				
3362	Trans. cover bolt and nut	1909-20	$\frac{8}{16}'' \times 1\frac{1}{2}''$. Order 2722					
3363	Trans. cover gasket (front)	1909-20	$\frac{8}{16}'' \times 1\frac{1}{8}'' \times 15\frac{1}{2}''$ Felt		50	Defy.	872B	1
3367	Trans. cover door screw	1909-20	$\frac{7}{16}'' \times 1\frac{1}{8}''$		20	Demain	430	6
3368	Universal ball cap (rear)	1909-20	$5\frac{1}{2}''$		4	Demarch	818	1
3369	Universal ball cap (front)	1909-20	Bearing included		16	Demarga	819D	1
3371	Universal ball cap screw	1909-20	$\frac{3}{16}'' \times 1\frac{1}{2}''$		50	Demise	731	2
3372	Universal ball cap bolt and nut	1909-20	Order 2722					
3373	Trans. cover screw	1909-20	Order 3072					
3376	TRANS. COVER	1911-19		95	00	Denier	826D	1
3376B	TRANS. COVER	1919-20	Starter type	95	00	Den	826E	1
3377B	Trans. cover gasket (pair)	1909-20	Cork	1	45	Dennet	885B	1
3378	Trans. cover sloping door	1911-20	$9\frac{1}{8}''$ long	1	45	Dental	1546D	1
3379B	Trans. cover sloping door gasket	1911-20	Cork	95		Denude	1547C	1
3380	Bendix cover	1919-20	Old No. 4906	3	80	Tendon	1763	1
3381	Bendix cover gasket	1919-20	Old No. 4915	30		Thigh	1764	1
3382	Trans. cover rear plate	1919-20	Old No. 4923	95		Deputy	1761	1
3383	Trans. cover front plate	1919-20	Old No: 4924	1	45	Descry	1758	1
GEARREGULERING								
3400	Trans. cultch release ring	1909-20	$3\frac{18}{16}''$ long	2	85	Detail	741	1
3402C	Clutch lever and shaft with release forks	1913-20		11	40	Dirk	1553-1548-4345	1
3402D	Clutch lever and shaft	1913-20		5	70	Disdain	1548	1
3403	Clutch lever screw and nut	1909-20	$\frac{3}{16}'' \times 1\frac{1}{16}''$	50		Dervish	1541-517	1
3405	Clutch lever pin	1909-20	$\frac{1}{8}'' \times 1\frac{1}{16}''$	20		Detour	1553	1
3406B	Clutch release fork—right or left	1913-20		2	85	Deuce	4345	2
3406C	Clutch release fork pin	1913-20	Order 3405					
3408	Clutch release fork key	1909-14		50		Dilate	836	2
3409	Clutch release fork clamp screw	1909-14	$\frac{3}{16}'' \times 1\frac{1}{16}''$	95		Dipper	835	2
3411	Clutch lever clevis pin	1909-20	Order 2564					
3413	TRANSMISSION BAND ASSEMBLY	1909-20		7	15	Disblame	838B	3
(Bands vil blive ombyttet i Filialen eller Fabrikken med 60 c hver)								
3415	Trans. band washer	1909-20	$\frac{29}{16}''$ hole x $\frac{7}{8}''$ dia	30		Discure	840	2
3416	Trans. band lining	1909-20		2	85	Disedge	1562	3
3419	Trans. band adjusting screw	1909-20	$\frac{9}{16}'' \times 3\frac{1}{8}''$	1	45	Disfriar	1535	1
3420	Trans. band adjusting screw nut	1909-20	$\frac{3}{4}'' \times 16$ thds.	50		Dislimb	1532	1
3421B	Trans. band ear iron rivet, per doz	1909-20	$\frac{3}{16}'' \times \frac{3}{16}''$	50		Dismal	843	12
3422B	Trans. band brass rivet, per doz	1909-17	$\frac{9}{16}'' \times 1\frac{1}{2}''$	50		Dismast	844B	6
3423B	Trans. band brass rivet, per doz	1909-20	$\frac{9}{16}'' \times \frac{5}{16}''$	50		Dismaw	845B	18
3425	Trans. band spring	1909-20	Coil	50		Dispark	841B	3
3426	Trans. band adjusting nut	1909-20	$\frac{7}{16}'' \times 20$ thds.	50		Displat	851	2
3427	Slow speed shaft	1909-20	$\frac{5}{16}'' \times 9\frac{1}{8}''$	2	40	Disputz	848B	1
3428	Slow speed notch	1909-20	On slow speed shaft	2	85	Disstrand	4327	1
3429	Slow speed notch pin	1909-20	$\frac{1}{4}'' \times 1\frac{1}{16}''$	20		Disrobe	1560	1
3432	Speed lever	1909-20		95		Distaff	862B	1
3434	Reverse pedal	1909-20		7	60	Disting	4324	1
3435	Brake and rev. pedal shaft	1909-20	$\frac{5}{16}''$ dia. x $7\frac{13}{16}''$	2	85	Distrite	849B	2
3436	Brake and rev. pedal support	1909-20		2	40	Distune	4325	2
3437	Brake and rev. support bolt and nut	1909-20	$\frac{3}{8}'' \times 1\frac{1}{2}''$	95		Ditcher	1534-8	2
3439	Brake pedal	1909-20		7	60	Dittost	4323	1
3440	Clutch pedal	1909-20		7	60	Ditty	854B	1
3441	Pedal pin	1909-20	Order 3405					
3442	Clutch pedal support	1909-20		1	90	Dookad	4326	1
3443	Clutch pedal support bolt and nut	1909-20	$\frac{5}{16}'' \times 2''$	95		Doorga	1536-8	1
3445	Slow speed connection	1909-20		50		Dorec	1540	1
3446	Slow speed con. lock nut	1909-20	$\frac{5}{16}'' \times 24$ thds.	30		Doric	44	1
3447	Slow speed con. clevis	1909-20		1	45	Dormer	802	1
3448	Controller quadrant	1909-20	On frame	2	40	Dormouse	309B	1
3449	CONTROLLER SHAFT WITH SPEED LEVER	1909-20		9	50	Doron	1557	1
3450	Controller shaft bracket	1909-20	On frame	1	90	Dorrer	311	2
3451	Controller shaft bracket felt	1909-20		10		Dorsal	314	2
3452	Controller shaft bracket bolt and nut	1909-20		50		Dorture	315-316	4
3455	HAND BRAKE LEVER ASSEMBLY	1909-20		19	00	Dotant	1550	1
3456	Hand brake lever pin	1909-20	Order 3129					
3456B	Hand brake lever pin	1909-20	Order 2574					
3457	Hand brake lever key	1909-17		50		Doublet	874	1
3458	Hand brake lever pawl	1909-20		95		Doucet	875	1

*Erstat med 3376B.

†Ilvis bestilt til at forny Gearkasse paa Vogne under No. 2044100, bestil ogsaa Haandbremsestang 3402B.

Forlang at faa ægte Ford Dele

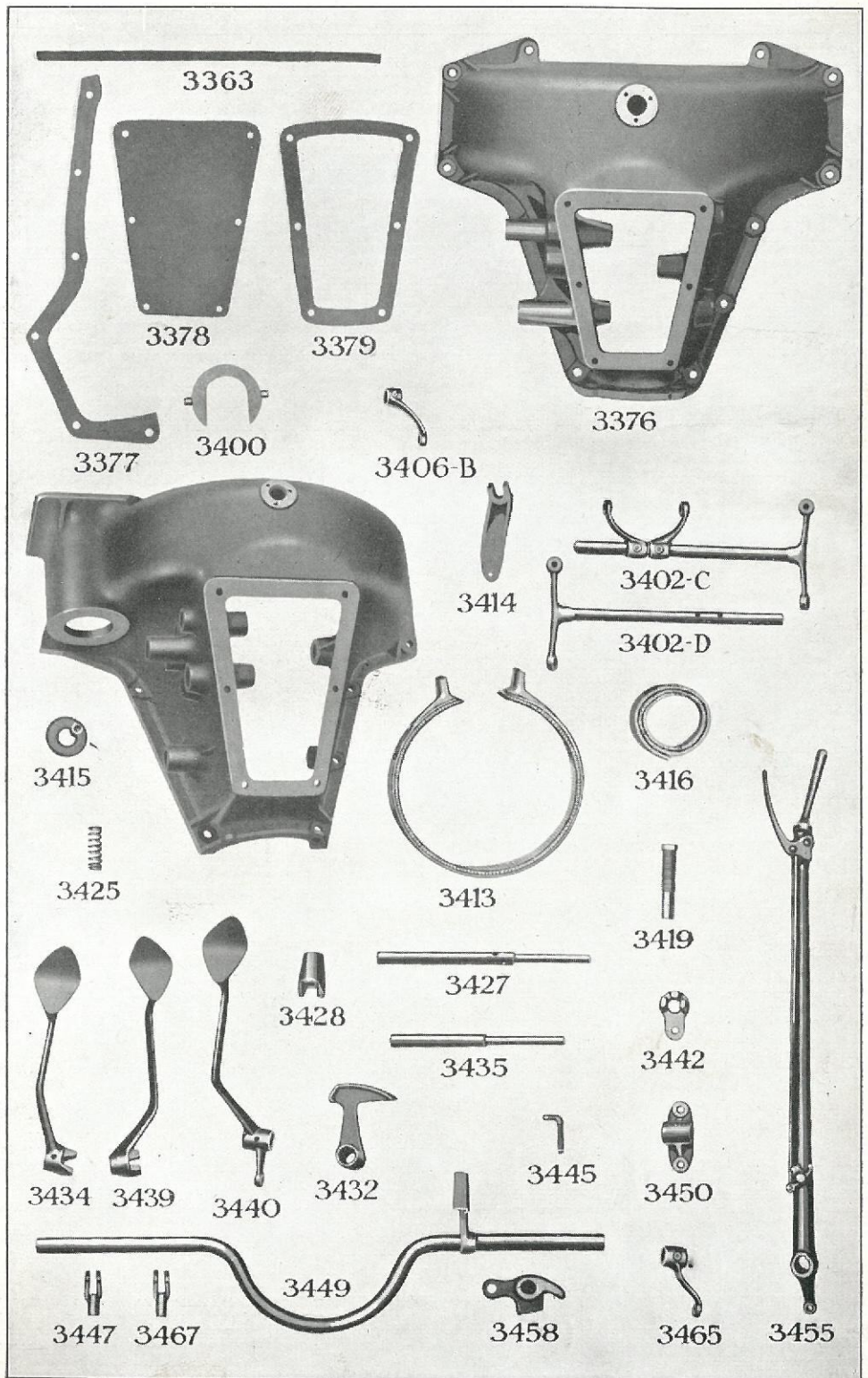

Del No.	Navn paa Del	Aar	Specifikationer	Pris	Kode Ord	Fabr. No.	Ant. Stk. pr. Vogn	Fragt Vægt
GEARREGULERING—Fortsat				Kr.				
3459.	Hand brake lever pawl pin.	1909-20.	$\frac{7}{16}$ " x $\frac{15}{16}$ "	30.	Doura.	876.	1	
3460.	Hand brake lever pawl rod.	1909-20.		95.	Dovecote.	877.	1	3 oz.
3462.	Hand brake lever pawl lift assembly.	1909-20.	Handle and spring.	95.	Dovekie.	4363.	1	2 oz.
3463.	Hand brake lever pawl lift spring.	1909-20.		20.	Dawcet.	888.	1	
3465.	HUB BRAKE LEVER ON CONTROLLERSHAFT	1909-20.		1 90.	Dawdy.	864.	1	3 oz.
3466.	Hub brake lever pin.	1909-20.	Order 3405.					
3467.	Hub brake lever clevis.	1909-20.	$\frac{2}{16}$ "					
3468.	Hub brake pull rod—right.	1909-20.	$\frac{5}{16}$ " long.	7 15.	Drongo.	891B.	1	
3469.	Hub brake pull rod—left.	1909-20.	$\frac{5}{16}$ " long.	7 15.	Dropax.	1513B.	1	
3470.	Hub brake rod support—right.	1909-20.		95.	Dropxy.	1367.	1	4 oz.
3471.	Hub brake rod support—left.	1909-20.		95.	Drugger.	1398.	1	4 oz.
3472.	Hub brake rod support bolt and nut.	1909-20.	$\frac{1}{4}$ " x $\frac{1}{8}$ "	50.	Duchess.	1308-1309.	2	
STYREMEKANISME								
3500C.	Steering gear assembly.	1911-20.	.51" long.	133 00.	Estopped.	5042.	1	
3501B.	Steering gear rim.	1909-20.	.15" dia., wood.	19 00.	Estrade.	901B.	1	1 lb., 6 oz.
3502.	Steering gear rim screw.	1909-20.	No. 12, $\frac{3}{4}$ "	20.	Eblis.	919.	4	
3503B.	Steering gear spider.	1909-20.	$\frac{13}{16}$ " over all	9 50.	Estrepe.	901B.	1	1 lb., 10 oz.
3503C.	Steering gear spider and rim.	1909-20.	.15" dia.	28 50.	Eudora.	995.	1	
3504.	Steering gear cover.	1909-20.	$\frac{2}{16}$ " x 18 thds.	3 80.	Ecbole.	5039.	1	10 oz.
3505.	Steering gear cover screw.	1909-20.	No. 6, $\frac{3}{16}$ "	20.	Eccope.	910.	1	
3506.	Steering gear cover bushing.	1909-20.	1" long, steel.	95.	Echo.	914.	1	2 oz.
3506B.	Steering gear driving pinion washer.	1909-20.	Steel.	30.	Eff.	5026.	1	
3507.	Steering gear internal gear case and bushing.	1909-20.		19 00.	Egg.	5036.	1	
3509.	Steering gear quadrant.	1909-20.		1 45.	Ectype.	906B.	1	7 oz.
3510.	Steering gear quadrant rivet.	1909-20.	$\frac{5}{16}$ " x $\frac{1}{4}$ "	10.	Eden.	5041.	2	
3511.	Steering gear wheel nut.	1909-20.	$\frac{5}{8}$ " x 16 thds.	95.	Edict.	913.	1	2 oz.
3512C.	Steering gear tubing assembly.	1912-20.	Applies to No. 3500C	76 00.	Ethicer.	5016.	1	
3513B.	Steering tubing flange screw and nut.	1911-20.	$\frac{5}{16}$ " x $\frac{19}{16}$ "	50.	Ethule.	5019-926.	1	
3513C.	Steering tubing flange screw and nut.	1911-20.	$\frac{5}{16}$ " x $\frac{15}{16}$ "	50.	Ettle.	5018-926.	3	
3516C.	Steering gear post.	1912-20.	Applies to No. 3500C	28 50.	Estricked.	5002.	1	
3517.	Steering gear pinions, each.	1909-20.	12 teeth	1 45.	Egad.	916.	3	
3518.	Steering gear pinion pin.	1909-20.	$\frac{3}{16}$ " x $\frac{19}{16}$ "	50.	Egest.	917.	3	
3519.	Steering gear drive pinion.	1909-20.	12 teeth	3 80.	Egger.	911.	1	7 oz.
3520.	Steering gear drive pinion key.	1909-20.	$\frac{3}{16}$ " sq. x $\frac{23}{32}$ "	30.	Egma.	909.	1	
3521.	Steering gear pinion shaft bushing.	1909-14.	$\frac{7}{16}$ " bore x $\frac{1}{2}$ "	2 85.	Egress.	912.	1	
3523.	Steering gear post castle nut.	1909-20.	Order 2568.					
3524E.	Throttle rod.	1912-20.	$\frac{47}{16}$ " Applies to No. 3500C	4 75.	Euter.	5033.	1	1 lb., 3 oz.
3525E.	Lead rod.	1912-20.	$\frac{51}{16}$ " Applies to No. 3500C	4 75.	Evans.	5037.	1	1 lb., 4 oz.
3527.	Lead and throttle rod spring.	1909-20.		30.	Elite.	935.	2	
3528.	Lead and throttle rod collar.	1909-20.	$\frac{5}{16}$ " bore x $\frac{9}{16}$ "	20.	Elope.	936.	2	
3529.	Lead and throttle rod pin.	1909-20.	$\frac{3}{16}$ " x $\frac{9}{16}$ "	10.	Elvan.	937.	5	
3530.	Lead rod lever.	1909-20.		1 45.	Emhank.	946.	1	
3531.	Throttle rod lever.	1909-20.		1 45.	Ember.	947.	1	
3532.	Throttle rod guide.	1909-20.	$\frac{3}{16}$ " bore.	95.	Emblem.	938.	1	
3534B.	Commutator pull rod.	1912-20.		95.	Embrace.	2082.	1	3 oz.
3535.	Carburetor pull rod.	1909-20.	$\frac{14}{16}$ " long.	95.	Emboss.	1329.	1	3 oz.
3536.	Ball and socket joint.	1909-20.		95.	Embraid.	1326.	1	1 oz.
3537.	Ball and socket joint nut.	1909-20.	$\frac{7}{16}$ " x 32 thds.	20.	Embrute.	1327.	1	
3539B.	Steering post bracket with bushing.	1911-20.	Touring	9 50.	Eupon.	996.	1	1 lb., 14 oz.
3539C.	Steering post bracket with bushing.	1918-20.	Truck—Old No. 1105	9 50.	Dream.	TT996.	1	
	Steering post bracket bolt and nut.	1909-20.	Order 3073 or 3074.					
3544.	Steering post bracket felt washer.	1909-20.		30.	Endow.	943.	1	
3545.	Steering post bracket bushing.	1909-20.	$\frac{3}{4}$ " bore, brass. 2 pieces.	2 85.	Envault.	944-5027.	1	2 oz.
3546.	Steer, post bracket block.	1909-20.	Wood	95.	Empact.	945.	1	3 oz.
3546B.	Steer, post bracket block.	1918-20.	Truck—Old No. 1106	50.	Drift.	TT945.	1	
3547.	Steering gear ball arm.	1909-20.		5 70.	Eparch.	929B.	1	11 oz.
3548.	Steering gear ball arm key.	1909-20.		50.	Ephod.	930.	1	
3549.	Steering gear bracket dust cap.	1918-20.	Truck—Old No. 1107	50.	Drum.	TT5044.	1	

Forlang at faa ægte Ford Dele

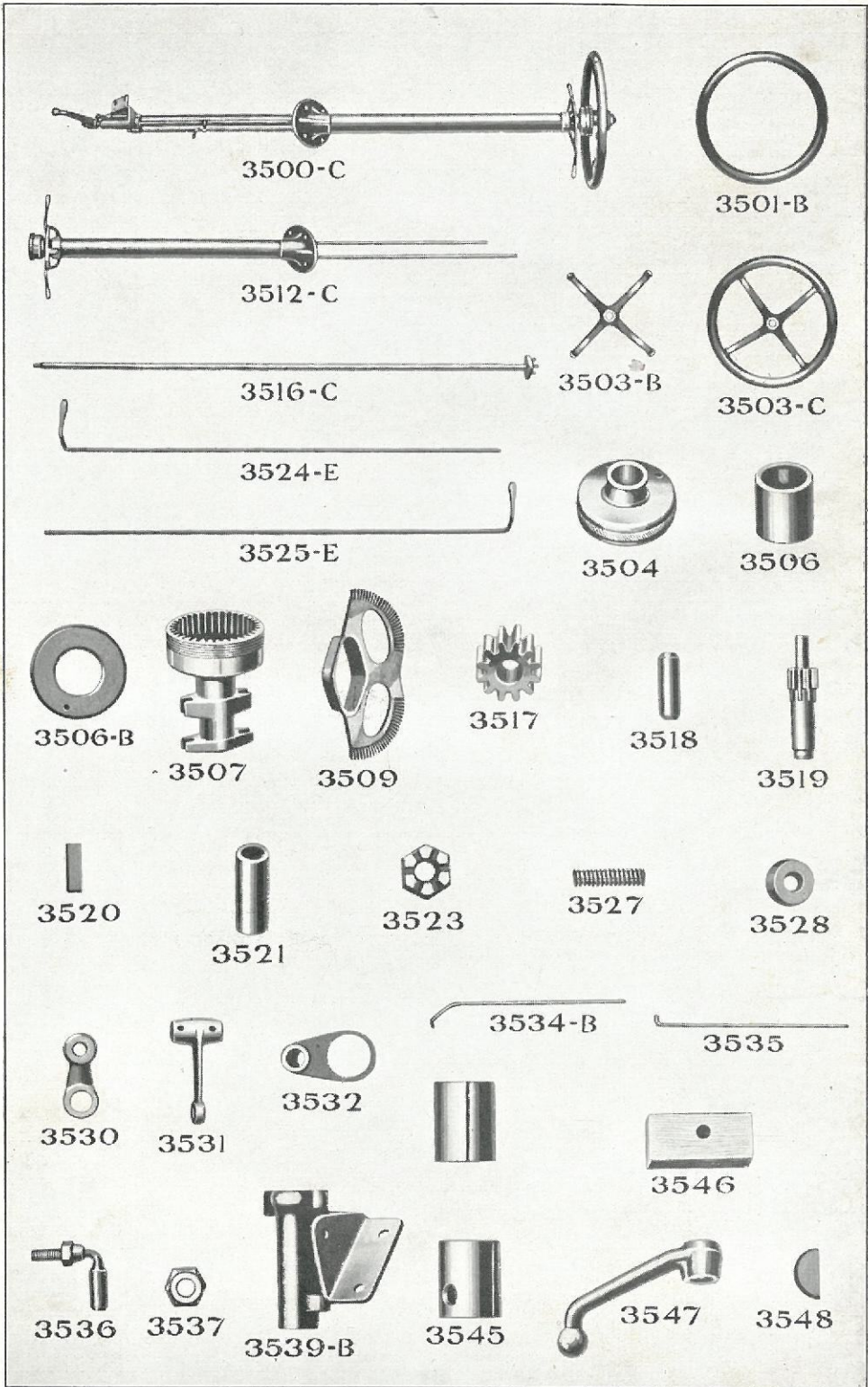

Del No.	Navn paa Del	Aar	Specifikationer	Pris	Kode Ord	Fabr. No.	Ant. Stk. pr. Vogn	Fragt Vægt
KAROSSERIDELE				Kr.				
3601B.	Body bracket on body.	1910-20.	Center and rear.	1 45.	Fabric.	1624	6	8 oz.
3602D.	Body bracket con, bolt and nut.		$7/16'' \times 59/16''$	50.	Facade.	5653-220.	6	
3602E.	Body bracket con, bolt and nut.		$7/16'' \times 1 1/16''$	50.	Fade.	2431-220.	2	
3624E.	Front floor rubber mat.	1915-20.	$28 3/4'' \times 29 3/16''$ Tr. & Rb't	19 00.	Faith.	7299	1	
3626B.	Floor board (first)	1915-20.	Tour, R'nab't & Coupelet.	7 15.	Farm.	7296	1	
3626C.	Floor board with plate (first)	1915-20.	Tour, R'nab't & Coupelet.	8 10.	Farrago.	4200	1	
3627B.	Floor board (second)	1915-20.	Tour, R'nab't & Coupelet.	7 15.	Faro.	7297	1	
3627C.	Floor board with plate (second)	1915-20.	Tour, R'nab't & Coupelet.	8 10.	Fascia.	4201	1	
3628.	Floor board (third)		Specify size	8 55.	Fasces	1404	1	
3628B.	Floor board with plate (third)	1915-20.	Specify size	9 50.	Fascine	7104	1	
3629.	Floor board (fourth)		Specify size	5 70.	Fasti.	1403	1	
3630.	Floor board forward plate for pedals	1909-20.	$21 1/16'' \times 3 3/16''$	95.	Fateful.	1400C	1	6 oz.
3632.	Floor board rear plate for pedals	1909-20.	$21 1/16'' \times 4 7/16''$	95.	Father.	1095C	1	12 oz.
3633.	Floor board plate for side lever	1909-20.	$2 3/16'' \times 8 3/16''$	95.	Fathom.	1094B.	1	5 oz.
3634D.	Dash.	1913-14.	$21 1/2'' \times 32 1/4''$	59 40.	Flamgo	5336	1	9 lb., 4 oz.
3634E.	Dash.	1915-16.		33 25.	Flect.	7462	1	4 oz.
3634G.	Dash.	1917-20.		38 00.	Fringe	8734	1	
3638.	Dash shield.	1909-19.	$1 1/16'' \times 3 7/16'' \times 13 3/16''$	95.	Faubit.	5432	1	5 oz.
3638B.	Dash shield	1919-20.		95.	Faubage.	5432B.	1	
3639.	Dash weatherstrip—side	1917-20.		50.	Flicker	8747	2	
3639B.	Dash weatherstrip—top.	1917-20.		2 85.	Floren.	8752	1	
*3640B.	Dash bracket—left	1911-16.		2 85.	Foal.	8722	1	
3640C.	Dash bracket—left	1917-20.		2 85.	Fowl.	8721	1	
*3641B.	Dash bracket—right	1911-16.		2 85.	Fowl.	8721	1	
3641C.	Dash bracket—right	1917-20.		2 85.	Fowl.	8721	1	
3642B.	Dash bracket to dash bolt and nut.	1917-20.		50.	Fume.	8740-926.	4	
3645.	Dash bracket to dash bolt and nut.	1909-16.	$5/16'' \times 1 1/4'' \times 18$ thds.	50.	Favos.	2427-341.	2	
3653B.	Dash to body bracket bolt and nut.	1915-20.	Touring car.	50.	Feud.	4248-341.	2	
3654.	Dash to body gasket	1918-19.		50.	Feaze.	8769	1	
3660C.	Tail lamp and license bracket assembly.	1915-19.	Touring car, Sedan, Town car	3 80.	Flour.	7506	1	
3660D.	Tail lamp and license bracket assembly.	1915-19.	Runabout and 1916-17 Coupelet.	3 80.	Flute.	7505	1	
3662.	Front license bracket-R.	1920.		95.	Fluffy.	287	1	
3663.	Front license bracket-L.	1920.		95.	Fluently.	288	1	
3667E.	Front seat cushion	1909-20.		95 00.	Farce.	8076	1	
3670D.	Rear seat cushion	1909-20.		95 00.	Forum.	7032	1	
3676B.	Tonneau mat.	1911-20.	$30'' \times 28''$ wool.	19 00.	Flatus.	1606B.	1	
FJEDRE								
3800.	Front spring.	1909-20.		38 00.	Gadan.	332	1	16 lb., 11 oz.
3801.	First leaf (main leaf)	1909-20.		9 50.	Golf.	2943	1	4 lb., 2 oz.
3802B.	Second leaf.	1909-20.		7 60.	Goose.	2935	1	3 lb., 7 oz.
3803.	Third leaf.	1909-16.	Tapered ends.	6 65.	Gaddish.	356	1	2 lb., 11 oz.
3803B.	Third leaf.	1916-20.	Square ends.	6 65.	Gopher.	2936	1	2 lb., 10 oz.
3804.	Fourth leaf.	1909-16.	Tapered ends.	5 70.	Gadoid.	357	1	2 lb., 6 oz.
3804B.	Fourth leaf.	1916-20.	Square ends.	5 70.	Gosling.	2937	1	2 lb., 3 oz.
3805.	Fifth leaf.	1909-16.	Tapered ends.	4 75.	Gallic.	358	1	1 lb., 13 oz.
3805B.	Fifth leaf.	1916-20.	Square ends.	4 75.	Gossip.	2938	1	1 lb., 8 oz.
3806.	Sixth leaf.	1909-16.	Tapered ends.	3 80.	Galol.	359	1	1 lb., 5 oz.
3806B.	Sixth leaf.	1916-20.	Square ends.	3 80.	Gothic.	2939	1	1 lb., 1 oz.
3807.	Seventh leaf.	1909-16.	Tapered ends.	2 40.	Gaiter.	360	1	15 oz.
3807B.	Seventh leaf.	1916-20.	Square ends.	2 40.	Gaily.	2947	1	
3808.	Front spring clip.	1909-20.		2 85.	Galena.	325B.	2	10 oz.
3809.	Front spring clip nut.	1909-20.	Order 2568.					
3811.	Front spring tie bolt and nut	1909-20.	$5/16'' \times 2 1/4''$	55.	Galley.	1362-1363.	1	1 oz.
3813.	Front spring hanger.	1909-20.		2 85.	Gambit.	246B.	4	4 oz.
3815.	Front and rear spring hanger nut	1909-20.	Order 2719.					
3817.	Front and rear spring hanger oiler.	1909-20.		50.	Gamin.	218	8	
3818.	Front spring perch—right.	1909-19.		7 60.	Gamut.	274	1	15 oz.
3818B.	Front spring perch—right.	1919-20.		7 60.	Garret.	274B.	1	
3819.	Front spring perch—left.	1909-19.		7 60.	Gander.	275	1	15 oz.
3819B.	Front spring perch—left.	1919-20.		7 60.	Gastar.	275B.	1	
3820.	Front spring perch bushing	1909-20.	$1 1/16'' \times 1 1/2''$	50.	Gangue.	230	4	1 oz.
3821.	Front spring perch nut	1909-20.	$5/16'' \times 18$ thds. Order 2828.					
3823.	Front spring leather.	1909-20.	$1 1/8'' \times 5 3/16''$	95.	Gannet.	262	1	2 oz.
3824.	REAR SPRING	1909-20.	$56''$ tread, 8 leaf.	114 00.	Ganoid.	353	1	
3825.	First leaf (main leaf)	1909-19.	Tapered ends.	19 00.	Gantlope.	361	1	9 lb.
3825B.	First leaf (main leaf)	1918-20.		19 00.	Gallop.	361B.	1	
3826.	Second leaf.	1909-19.	Tapered ends.	16 65.	Gantois.	362	1	7 lb., 7 oz.
3826B.	Second leaf.	1918-20.	Square ends.	16 65.	Galore.	362B.	1	
3827.	Third leaf.	1909-19.	Tapered ends.	15 70.	Ganza.	363	1	6 lb., 11 oz.
3827B.	Third leaf.	1918-20.	Square ends.	15 70.	Gamish.	363B.	1	

*)Efterbor Ramme og brug ny Model-Holder No. 3640C og 3641C.

Forlang at faa ægte Ford Dele

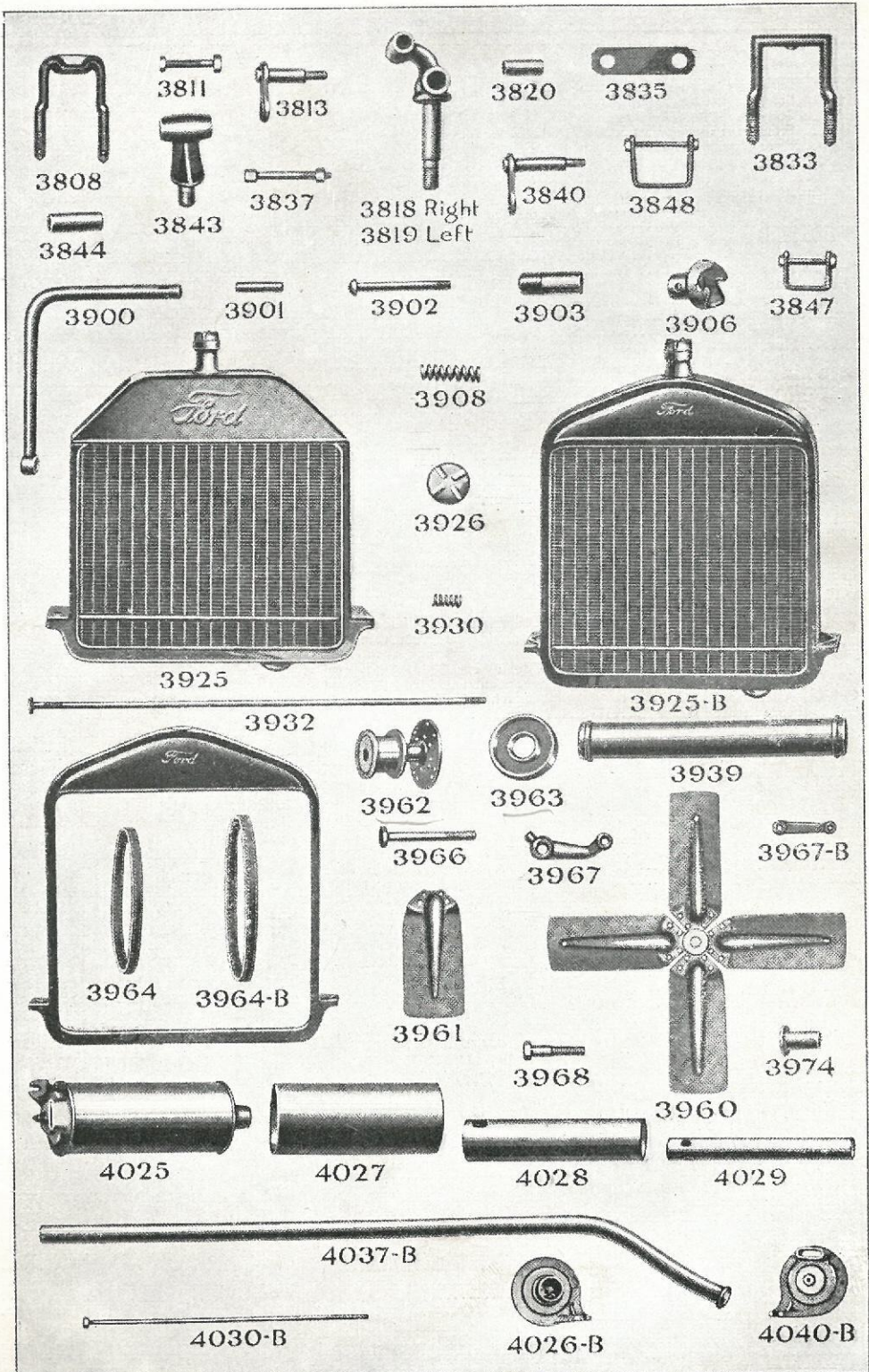

Del No.	Navn paa Del	Aar	Specifikationer	Pris	Kode Ord	Fabr. No.	Ant. Stk. pr. Vogn	Fragt Vægt
FJEDRE—Fortsat				Kr.				
3828...	Fourth leaf.....	1909-19.	Tapered ends.....	14 25.	Gaphare...	364.....	1	6 lb., 5 oz.
3828B...	Fourth leaf.....	1918-20.	Square ends.....	14 25.	Gander.....	364B.....	1
3829...	Fifth leaf.....	1909-19.	Tapered ends.....	13 30.	Garden.....	365.....	1	5 lb., 13 oz.
3829B...	Fifth leaf.....	1918-20.	Square ends.....	13 30.	Genus.....	365B.....	1
3830...	Sixth leaf.....	1909-19.	Tapered ends.....	12 35.	Garland.....	366.....	1	5 lb., 11 oz.
3830B...	Sixth leaf.....	1918-20.	Square ends.....	12 35.	Ghoul.....	366B.....	1
3831...	Seventh leaf.....	1909-19.	Tapered ends.....	10 95.	Garlic.....	367.....	1	5 lb., 7 oz.
3831B...	Seventh leaf.....	1918-20.	Square ends.....	10 95.	Giant.....	367B.....	1
3832...	Eighth leaf.....	1909-19.	Tapered ends.....	9 50.	Garner.....	368.....	1	3 lb., 8 oz.
3832B...	Eighth leaf.....	1918-20.	Square ends.....	9 50.	Gimlet.....	368B.....	1
3833...	Rear spring clip.....	1909-20.	4 ¹ / ₁₆ ".....	2 40.	Game.....	326.....	211 oz.
3834...	Rear spring clip nut.....	1909-20.	Order 2548.....					
3835...	Rear spring clip bar.....	1909-20.	3 ¹ / ₁₆ " x 1 ¹ / ₁₆ " x 4" x 1 ¹ / ₁₆ ".....	95.	Gascon.....	329.....	27 oz.
3837...	Rear spring tie bolt and nut.....	1909-20.	3 ¹ / ₈ " x 2 ¹ / ₁₆ ".....	55.	Gastic.....	1352-1353.....	12 oz.
3840...	Rear spring hanger.....	1909-20.		2 85.	Gaulus.....	91 ¹ / ₂ B.....	45 oz.
3842...	Rear spring leather pad.....	1909-20.	2" x 10 ¹ / ₄ ".....	95.	Gavel.....	94.....	12 oz.
3843...	Rear spring perch.....	1909-20.		5 70.	Gavot.....	2804.....	212 oz.
3844...	Rear spring perch bushing.....	1909-20.	3 ¹ / ₁₆ " bore x 3 ¹ / ₄ " dia. x 2".....	50.	Gawky.....	172.....	42 oz.
3845...	Rear spring perch nut.....	1909-20.	3 ¹ / ₁₆ " x 16 thds.....	95.	Gazara.....	174.....	22 oz.
3847...	Front spring clip assembly with bolt and nut.....	1909-16.		95.	Gazzam.....	374.....	23 oz.
3847B...	Front spring clip assembly with bolt and nut.....	1916-20.	(for 6 leaf spring).....	95.	Gown.....	2953.....	2
3848...	Rear spring clip assembly with bolt and nut.....	1909-17.		95.	Gecko.....	376.....	24 oz.
3848B...	Rear spring clip assembly with bolt and nut.....	1918-20.		95.	Gemmy.....	378.....	
BAGFJEDER—60 TOMMER SPORVIDDE								
3850...	Rear spring.....	1909-16.	.48 ¹ / ₂ " long, 8 leaf.....	142 50.	Geddur.....	1704.....	1
3851...	Rear spring clip.....	1909-16.	3 ¹ / ₁₆ " x 4 ⁷ / ₁₆ ".....	2 40.	Gelder.....	1737.....	212 oz.
3852...	Rear spring tie bolt and nut.....	1909-16.	2 ¹ / ₈ " x 3 ⁷ / ₁₆ ".....	95.	Gemote.....	1738-1353.....	13 oz.
3853...	First leaf (main leaf).....	1909-16.		28 50.	Gemsbok.....	1739.....	1	10 lb., 10 oz.
3854...	Second leaf.....	1909-16.		25 75.	Gershon.....	1740.....	1	9 lb., 1 oz.
3855...	Third leaf.....	1909-16.		19 00.	Gerper.....	1741.....	1	8 lb., 3 oz.
3856...	Fourth leaf.....	1909-16.		16 65.	Gherkin.....	1742.....	1	6 lb., 3 oz.
3857...	Fifth leaf.....	1909-16.		15 20.	Gibbet.....	1743.....	1	5 lb., 8 oz.
3858...	Sixth leaf.....	1909-16.		14 25.	Ginger.....	1744.....	1	6 lb., 10 oz.
3859...	Seventh leaf.....	1909-16.		12 35.	Gipsire.....	1745.....	1	4 lb., 6 oz.
3860...	Eighth leaf.....	1909-16.		10 45.	GISarm.....	1746.....	1	3 lb., 9 oz.
STARTHAANDTAG								
3900...	Starting crank only.....	1909-20.		7 60.	Hernia.....	519B.....	1	1 lb., 10 oz.
3901...	Starting crank handle.....	1909-20.		1 90.	Heron.....	520.....	12 oz.
3902...	Starting crank handle bolt.....	1909-20.	4 ⁷ / ₈ " x 4 ⁷ / ₈ ".....	95.	Herpes.....	521.....	14 oz.
3903...	Starting crank sleeve.....	1909-20.	4 ¹ / ₁₆ " bore x 8 ¹ / ₁₆ " x 2 ³ / ₄ ".....	95.	Hesper.....	523.....	14 oz.
3905...	Starting crank ratchet pin.....	1909-20.	1 ¹ / ₈ " bore x 8 ¹ / ₁₆ " x 2 ³ / ₄ ".....	50.	Hestern.....	4491.....	1
3906...	Starting crank ratchet.....	1909-20.		2 40.	Hetman.....	528.....	18 oz.
3908...	Starting crank spring.....	1909-20.		50.	Hilding.....	626.....	1
3909...	Starting crank handle spring.....	1915-20.		30.	Hitter.....	5911.....	1
KØLER—THERMO-SYPHON								
3925...	Radiator.....	1909-16.		285 00.	Hominy.....	1100C.....	1
3925B...	Radiator.....	1917-20.		266 00.	Honey.....	8700.....	1
3925C...	Radiator less shell.....	1917-20.		244 65.	Hop.....	8736.....	1
3926...	Radiator cab.....	1909-20.		1 90.	Hothir.....	8714.....	12 oz.
3928...	Radiator pad.....	1909-20.	Leather.....	50.	Hovel.....	1105.....	2
3929...	Radiator stud and nut.....	1909-19.	3 ¹ / ₈ " x 2 ⁷ / ₁₆ ".....	95.	Hoxy.....	1162-1154.....	21 oz.
3929B...	Radiator stud and nut.....	1919-20.		95.	Hunger.....	1162B-1154.....	2
3930...	Radiator stud spring.....	1909-20.	Order No. 2742.....					
3931 ¹ / ₂ ...	Radiator stud washer nut.....	1909-20.	2 ¹ / ₂ " x 24 thds.....	50.	Huffish.....	1161.....	2
3932...	Radiator rod.....	1909-20.	20 ¹ / ₁₆ " long.....	1 90.	Huller.....	1111B.....	18 oz.
3934...	Radiator rod nut.....	1909-20.	3 ¹ / ₈ " x 24 thds.....	30.	Humbler.....	517.....	1
3939...	Outlet connection pipe.....	1909-20.	1 ³ / ₄ " x 12".....	5 80.	Huemic.....	1121.....	112 oz.
3940...	Outlet connection cock.....	1909-20.	Order 3079.....					
3944...	Outlet connection hose.....	1909-20.	1 ³ / ₄ " x 2 ³ / ₄ ".....	1 45.	Hungry.....	507.....	23 oz.
3945...	Outlet connection hose clip.....	1909-20.	2 ¹ / ₁₆ " dia.....	50.	Hunter.....	554.....	41 oz.
3947...	Radiator shell.....	1917-19.		21 40.	Hymn.....	8737.....	1
3947B...	Radiator shell.....	1919-20.		21 40.	Hymnal.....	8737B.....	1
3975...	Radiator stud spring upper thimble.....	1919-20.		20.	Hump.....	1115.....	1
3976...	Radiator stud spring lower thimble.....	1919-20.		30.	Hurst.....	1114.....	1
KØLERVERTILATOR								
3960...	Fan and pulley assembly.....	1909-20.		14 25.	Hutten.....	619.....	1	1 lb., 8 oz.
3961...	Fan blade.....	1909-20.		95.	Hyades.....	611.....	43 oz.
3961B...	Fan blade rivets, per dozen.....	1909-20.		50.	Hyad.....	1566.....	16
3961C...	Fan blade assy.....	1920.		2 85.	Iambe.....	620.....	1
3962...	Driven fan pulley.....	1909-20.	Brass, upper.....	7 60.	Hydra.....	618.....	113 oz.
3962B...	Driven fan pulley with bushing.....	1920.		9 50.	Iaon.....	618B.....	1

Forlang at faa ægte Ford Dele

Del No.	Navn paa Del	Aar	Specifikationer	Pris	Kode Ord	Fabr. No.	Ant. Stk. pr. Vogn	Pragt Vægt
KØLERVERTILATOR—Fortsat.					Kr.			
3963	Fan drive pulley	1909-20	Steel, lower	2 85	Hydrant	602	1	8 oz.
3964	Fan belt	1909-16		2 85	Hydrant	609	1	2 oz.
3964C	Fan belt	1917-20	In carton	3 80	Impel	609B	1	
3964D	Fan belt	1920		4 75	Idiom	609C	1	
3966	Fan shaft	1909-20	$7\frac{1}{16}'' \times 4\frac{3}{16}''$	1 90	Hyper	606	1	4 oz.
3966B	Fan shaft	1920		1 45	lasius	606B	1	
3967	Fan bracket	1909-16		3 80	Hypo	604	1	7 oz.
3967B	Fan bracket	1917-20		3 80	Idyl	604B	1	
3968	Fan bracket bolt	1909-20	$\frac{3}{16}'' \times 2\frac{3}{16}''$	1 45	Hyper	605	1	3 oz.
3970	Fan grease cup	1909-20		95	Hyppish	601	1	
3973	Fan adjusting screw and nut	1909-20	$\frac{3}{16}'' \times 1\frac{13}{16}''$	50	Hyssop	645-517	1	1 oz.
3974	Fan driven pulley bushing	1917-20		1 90	Knag	8757	1	
3974B	Fan driven pulley bushing	1920		1 90	Ibhar	8757B	2	
3980	Fan pulley plug	1920		30	Ibidem	633	1	
3981	Fan pulley gasket	1920		10	Icarian	634	1	
3982	Fan shaft cap	1920		20	Icilius	635	1	
3983	Fan shaft felt washer	1920		20	Iconism	637	1	
3984	Fan blade screw	1920		10	Ictus	652	4	
3985	Fan blade screw washer	1920	Order T 3261C				4	
3986	Fan shaft nut	1920	Order T 2719				1	

LYDPOTTE

4025	Muffler assembly	1909-20		19 00	Jobal	1200	1	8 lb.
4026B	Muffler head—front	1917-20		4 30	Julep	1202C	1	
4027	Muffler shell—outer	1909-20	5" dia. x 12"	2 40	Jabin	1203	1	1 lb., 1 oz.
4028	Muffler shell—middle	1909-20	3 $\frac{1}{2}$ " dia. x 13"	2 40	Jackal	1204	1	12 oz.
4029	Muffler shell—inner	1909-20	2" dia. x 14"	1 45	Jaday	1205	1	1 lb., 3 oz.
4030	Muffler rod	1909-17	$\frac{5}{16}'' \times 13\frac{3}{4}''$	95	Jadish	1206	3	4 oz.
4030B	Muffler rod	1917-20		95	Jocose	1206B	1	
4031	Muffler rod nut	1909-20	$\frac{7}{16}'' \times 24$ thds.	Order 3446				
4037B	Long exhaust pipe	1909-20		19 00	Jaunty	1214	1	1 lb., 12 oz.
4040B	Muffler head—rear	1917-20		4 30	Jesuit	1201D	1	
4041	Muffler head to frame bolt and nut	1917-20	Order 4808B					

MOTORHJÆLM

4050	Hood	1909-16	.22" long	71 25	Jibsam	1300	1	7 lb., 8 oz.
4050B	Hood	1917-20		66 50	Jilt	8726	1	
4051	Hood handle	1909-20	.51 $\frac{1}{2}$ " long	50	Jingal	1314	2	2 oz.
4052	Hood clip	1909-16	.31 $\frac{1}{2}$ "	95	Jippo	1310	4	2 oz.
4052B	Hood clip	1917-20		95	Jowl	8731	4	
4053	Hood clip spring	1909-16		30	Jockey	1311	4	
4053B	Hood clip spring	1917-20		30	Juice	8734	4	
4056	Hood board—left	1909-16	.22 $\frac{3}{4}$ " long	2 40	Johim	1339	1	11 oz.
4056B	Hood board—left	1917-20		2 40	Kilt	8742	1	
4057	Hood board—right	1909-16	.22 $\frac{3}{4}$ " long	2 40	Jorum	1340	1	11 oz.
4057B	Hood board—right	1917-20		2 40	Kine	8741	1	
4060B	Hood support on dash	1915-16		14 25	Juror	7464	1	
4060C	Hood pad (on dash)	1917-20		95	Kite	8711	2	
4060D	Hood pad (on radiator shell)	1917-20		1 90	Kid	8710	1	
4061B	Hood clasp (on dash)	1917-20		50	Kit	8720	1	
4061C	Hood clasp (on dash) screw	1917-20		20	Knee	8763	2	
4073	Hood block support—front right	1917-20		50	Knot	8745	1	
4074	Hood block support—front left	1917-20		50	Kiln	8744	1	
4075	Hood block support—rear right	1917-20		50	King	8745	1	
4076	Hood block support—rear left	1917-20		50	Kirk	8746	1	

KINGSTON KARBURATOR

6100	Carburetor complete	1909-20		57 00	Mason	553E	1	3 lb., 14 oz.
6101A	Carburetor float assb.	1917-20		9 50	Moslem	6369	1	
6101	Float with lever	1915-16		9 50	Marsh	6351	1	
6127A	Gasoline valve	1917-20		3 35	Moral	6377	1	
6115	Spray needle assembly	1910-20		4 75	Medal	3010	1	

Dele til 1909-16 Karburator leveret af Bryne Kingston Co., Kokomo Ind.

FORD KARBURATOR (MODEL "G")

6040	Carburetor complete	1909-20		57 00	Mire	553D	1	3 lb., 3 oz.
4451A	Float with lever	1914-20		9 50	Muzzle	6335	1	
4452A	Spray needle assembly	1914-20		1 90	Myrtle	6335	1	
4453A	Gasoline inlet needle	1914-20		2 85	Mystic	6324	1	

Andre rekvirerede Dele maa bestilles med Plade Nummer. Priserne vil blive opgivet ved Henvendelse.

Dele til 1909-15 Karburator leveret af Holley Kerosene Carburetor Co., Detroit, Mich.

HOLLEY KARBURATOR (MODEL "NH")

4451B	Float with lever	1920		11 90	Mutage	6333B	1	
4452B	Spray needle assembly	1920		5 70	Mutiny	6335B	1	

Forlang at faa ægte Ford Dele

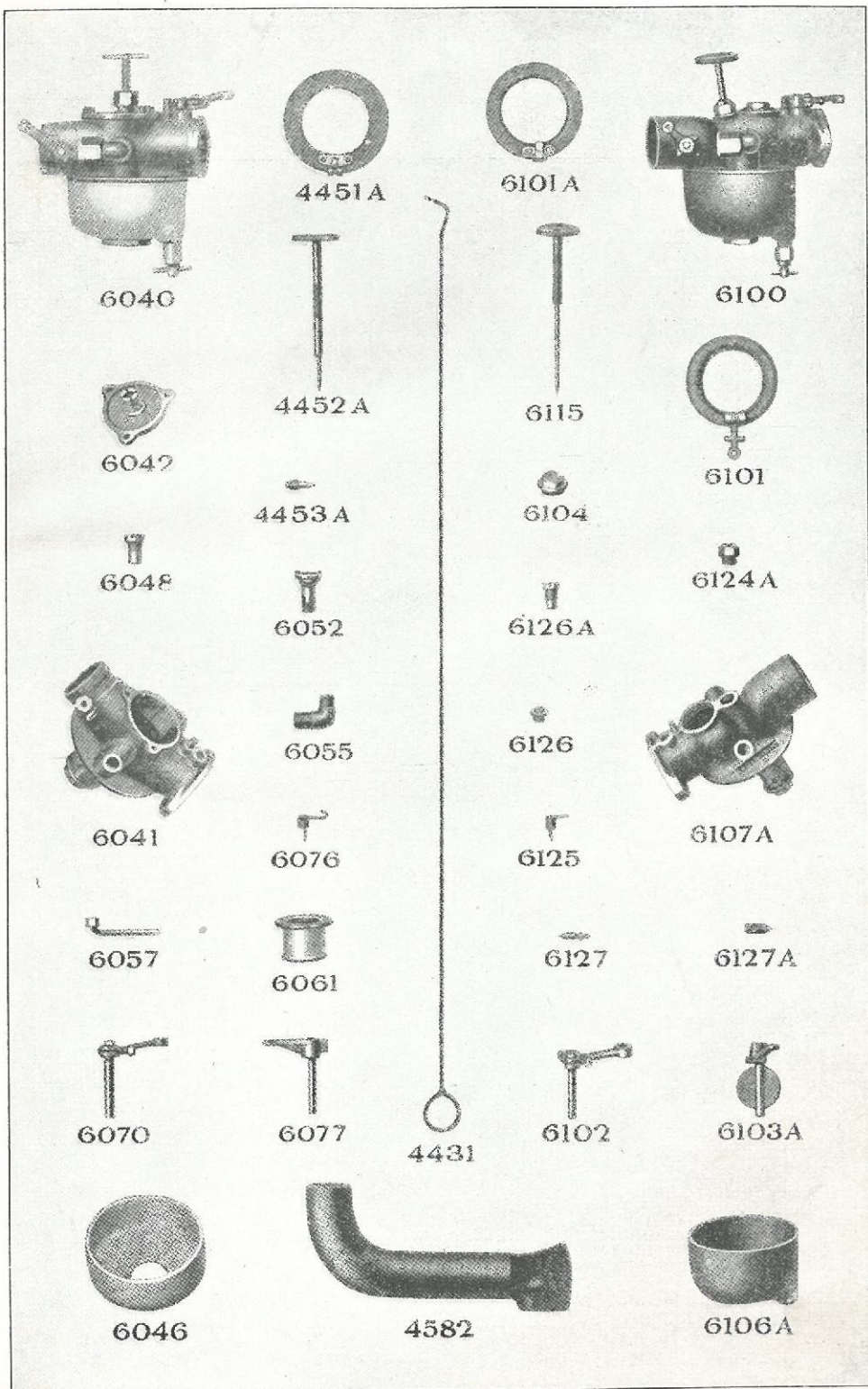

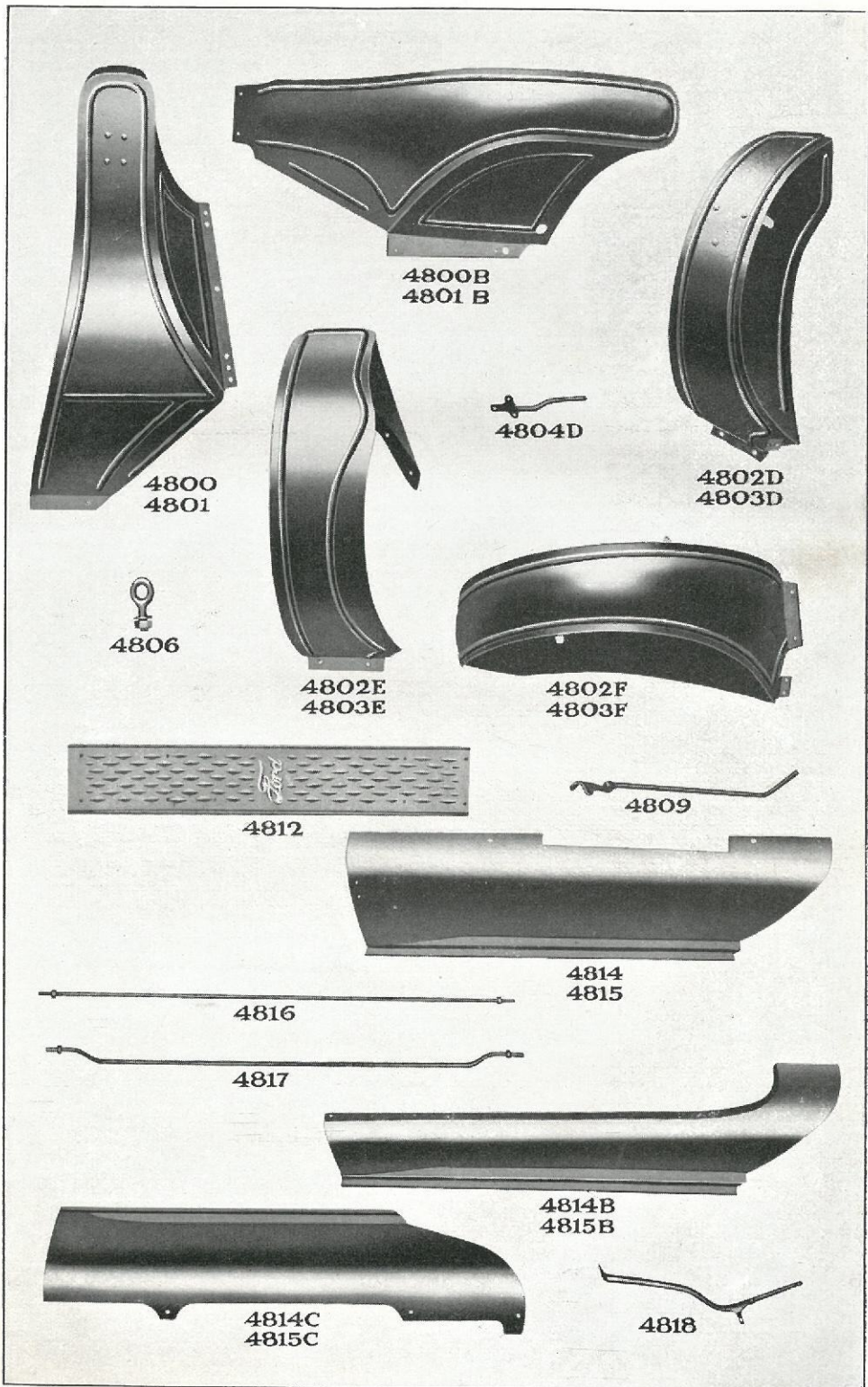

4800
4801

4800B
4801 B

4802D
4803D

4804D

4806

4802E
4803E

4802F
4803F

4812

4809

4814
4815

4816

4817

4814B
4815B

4814C
4815C

4818

Del No.	Navn paa Del	Aar	Specifikationer	Pris	Kode Ord	Fabr. No.	Ant. Stk. pr. Vogn	Frgt Vægt
KARBURATORILBEHØR				Kr.				
4127A	Carb. adjusting rod bracket	1909-20	On dash	50	..	Lastage 1357	1	
4129A	Carb. adjusting rod	1909-20		1 90	..	Latten 7920	1	4 oz.
4130	Carb. flange bolt and nut	1909-20		1 45	..	Leaper 1388-517	2	1 oz.
4134	Carb. flange gasket	1909-20		50	..	Lecturn 1380B	1	
4431	Carb. priming rod	1909-20		50	..	Loach 2000	1	1 oz.
4582	Carb. hot air pipe	1912-20		1 90	..	Monkey 686	1	6 oz.
4583	Priming bell crank	1919-20	Starter type	2 85	..	Tenet 7691	1	
4585	Priming rod plate	1919-20	Coupe starter type	1 45	..	Thrum 7664	1	
4586	Priming rod plate	1919-20	Sedan starter type	1 45	..	Thruse 7665	1	
4587B	Priming rod	1919-20	Sedan starter type	2 40	..	Thule 6628	1	
4588B	Priming rod	1919-20	Coupe, T. C. & Rbt. starter type	2 40	..	Thumb 6627	1	
4589	Carburetor priming rod	1919-20	Starter type	50	..	Thunder 8797B	1	

SKÆRME—56 TOMMER SPORVIDDE

4800B	Front fender—right	1917-20	All Cars	66 50	..	Nook 7976	1	
4801B	Front fender—left	1917-20	All Cars	66 50	..	Noose 7977	1	
4802F	Rear fender—right	1917-20	All Cars	57 00	..	Norse 8850	1	
4803F	Rear fender—left	1917-20	All Cars	57 00	..	Nougat 8851	1	
4804D	Rear fender iron—right and left	1913-20	Touring car	1 90	..	Smile 5405	2	12 oz.
4804E	Rear fender iron—right	1913-20	Torpedo & Coupelet	5 70	..	Shire 5563	1	1 lb., 7 oz.
4804F	Rear fender iron—left	1913-20	Torpedo & Coupelet	5 70	..	Shrub 5390	1	1 lb., 7 oz.
4804G	Rear fender iron—right or left	1916-17	Sedan	4 75	..	Nubble 8154A	2	
4804K	Fender iron—right or left	1918-20	Sedan	4 75	..	Shoggle 8154B	2	
4805B	Rear fender iron bolt and nut	1915-20	Touring, $\frac{5}{16}$ " x $\frac{3}{4}$ "	50	..	Signet 8161-341	6	
4806	Fender eye bolt, nut and washer	1909-20	Old No. 2935	95	..	Blenny 1915	6	3 oz.
4808	Front fender iron bolt and nut (side)	1910-20	$\frac{9}{8}$ " x $2\frac{29}{32}$ "	50	..	Shovel 1323-8	2	1 oz.
4808B	Front fender iron bolt and nut (bottom)	1910-20	$\frac{3}{8}$ " x $1\frac{1}{32}$ "	50	..	Siren 347-8	2	
4808C	Front fender apron to frame bolt and nut	1915-20	$\frac{1}{4}$ " x $\frac{5}{8}$ "	50	..	Sickle 4088-1309	4	
4809	Front fender iron—right or left	1909-20		8 55	..	Sistom 343	2	1 lb., 14 oz.

TRINBRÆDDER OG STÆNKESKÆRME—56 TOMMER SPORVIDDE

4812	Running board—right or left	1909-20	44 $\frac{7}{8}$ " long	23 75	..	Shrew 5418	1	
4814C	Running board shield—right	1917-20	All Cars	28 50	..	Shrine 7986	1	
4815C	Running board shield—left	1917-20	All Cars	28 50	..	Shroud 7987	2	
4816	Running board truss rod—front with nuts	1909-20		4 75	..	Skybird 5804	1	2 lb., 2 oz.
4817	Running board truss rod—rear with nuts	1909-20		4 75	..	Skyman 5805	1	2 lb., 2 oz.
4817B	Truss rod nut			30	..	339	4	
4818	Running board bracket	1909-20		9 50	..	Skyhawk 335	4	1 lb., 15 oz.
4818B	Running board bracket assembly			14 25	..	Skyish 2926	2	
4819	Running board fender bolt and nut	1909-20	$\frac{1}{4}$ " x $1\frac{1}{2}$ "	50	..	Boaster 1344B-1309	8	
4819B	Running board bolt & nut	1909-20	$\frac{5}{16}$ " x $1\frac{3}{4}$ "	50	..	Bolary 8448-341	8	

TRINBRÆDDER—LASTAUTOMOBILER

4830	Running board—right or left	1918-20	Old No. 1129	7 15	..	Gull TT-5418	2	
4831	Running board bracket	1918-20	Old No. 1130	3 80	..	Heck TT-2926	4	
4832	Running board bracket brace	1918-20	Old No. 1131	1 45	..	Hedge TT-2927	2	
4833	Running board bracket rear brace	1918-20	Old No. 1132	2 85	..	Hedging TT-2929	1	

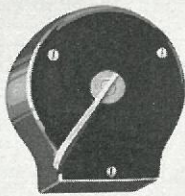

4728

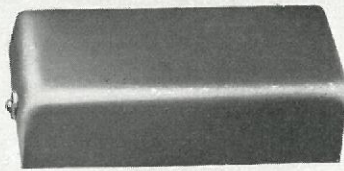

4727-B



4731

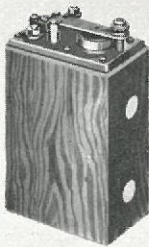

4732

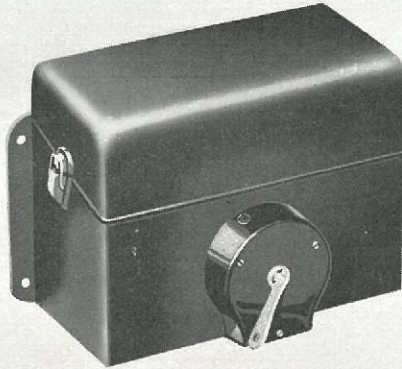

4725



4733

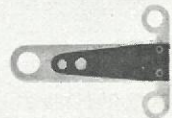

4734

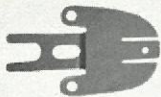

4736

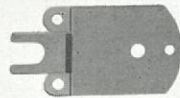

4736-A



4739

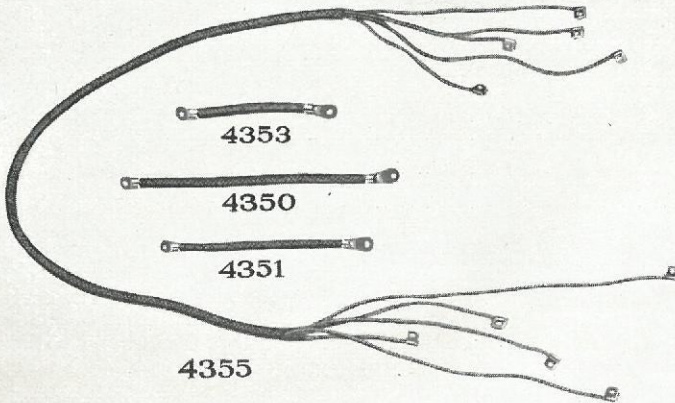

4353

4350

4351

4355



4737



4737-A



4740

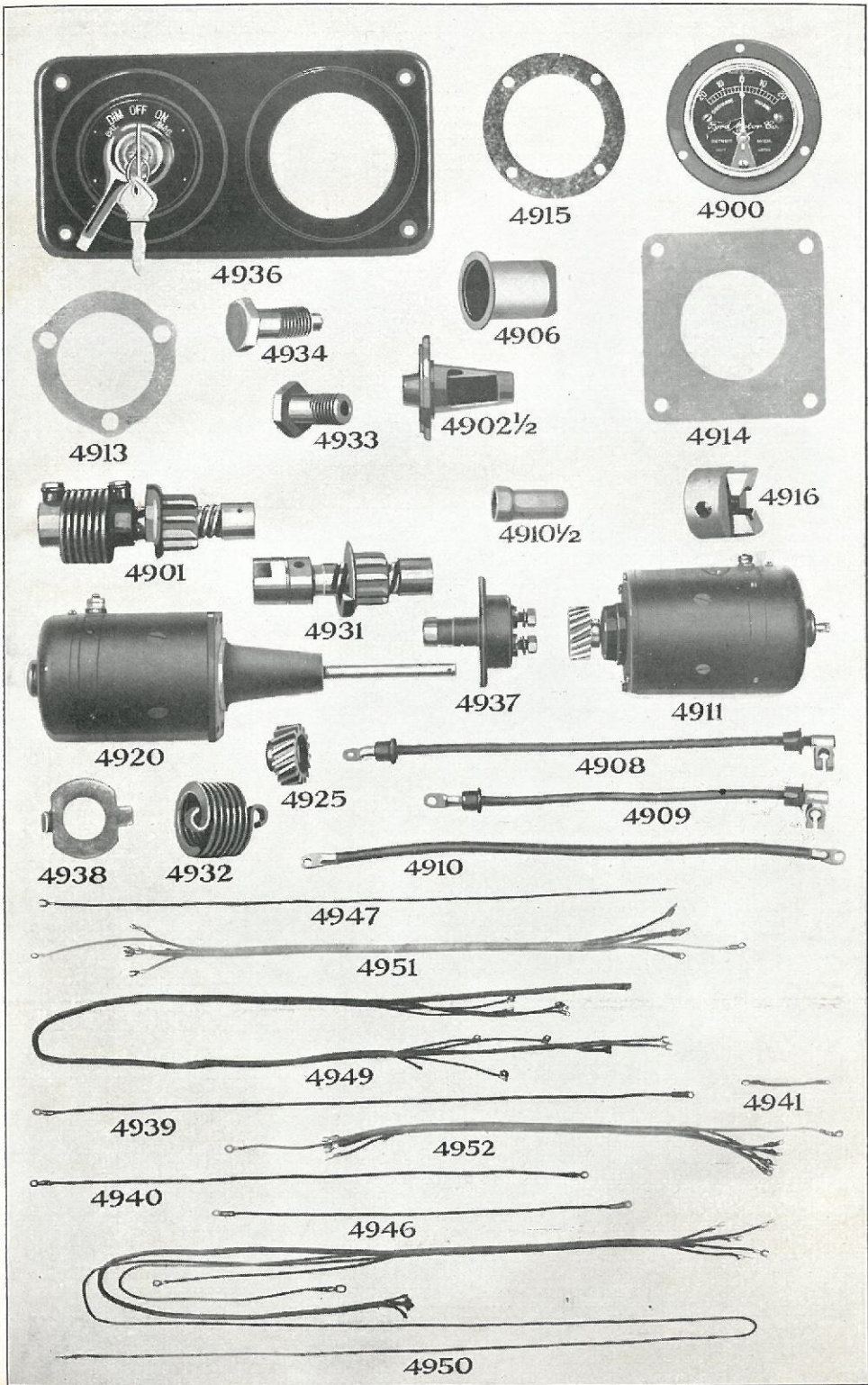

Del No.	Navn paa Del	Aar	Pris	Kode Ord	Fabr. No.	Ant. Stk. pr. Vogn	Fragt Vægt
FORD TÆNDINGSINDUKTIONSRULLE							
			Kr.				
5000	Coil (includes switch)	1909-20	123 50	Negus	1383	1	
5001	Coil (starter type)—less switch	1909-20	116 40	Neil	1383B	1	
5002	Coil box with cover (includes switch)	1914-20	28 50	Nenia	5858	1	
5003	Coil box with cover (starter type)—less switch	1919-20	21 40	Nepeta	5858B	1	
5004	Coil box cover	1915-20	2 85	Neptune	7910	1	
5005	Switch cover	1914-17	50	Nones	5835	1	
5005B	Switch cover	1918-20	95	Nonage	5835B	1	
5006	Switch plug	1914-20	50	Nopal	5815	1	
5007	Coil unit, 3 ¹ / ₂ " x 2 ¹ / ₂ " x 5"	1914-20	23 75	Noggin	5845	4	
5008	Vibrator with tungsten point	1914-20	1 45	Nonce	6797	4	
5009	Vibrator bridge with tungsten point	1914-20	1 90	Novia	6702	4	
AFBRYDER							
5010	Switch assembly (on coil)	1914-20	7 15	Nidor	5873	1	
5012	Switch (ignition) (starter type on instrument board)	1919-20	19 00	Nolad	7675E	1	
5013	Keys (switch)—give serial number	1919-20	1 45	Thrall	5815B	1	
5014	Starting switch (on floor board)	1919-20	9 50	Topaz	8792	1	
5015	Extension (starting switch plunger)	1919-20	95	Tetric	8793	1	
AMMETER							
5016	Ammeter	1919-20	21 40	Tassel	7680	1	
5017	Ammeter lens and rim	1919-20	2 85	Tensor	8105	1	
BENDIX SYSTEM							
5018	Bendix	1919-20	57 00	Tattler	1883	1	
5019	Head (Bendix)	1919-20	4 75	Thine	2007	1	
5020	Key (Bendix)	1919-20	20	Tholl	1751	1	
5021	Shaft and gear (Bendix)	1919-20	42 75	Thurl	2026	1	
5022	Spring (Bendix)	1919-20	7 15	Tinge	2006	1	
5023	Screw (Bendix shaft spring)	1919-20	95	Tinsel	1983	1	
5024	Screw (Bendix head spring)	1919-20	95	Tipple	1781	1	
5025	Washer (Bendix spring screw lock)	1919-20	50	Tipsy	1782	2	
LEDNINGER							
5026	Spark plug wire 14 ¹ / ₈ " No. 1 cyl	1909-20	1 45	Nohob	1365	1	
5027	Spark plug wire (also magneto to coil) 10 ¹ / ₂ " No. 2 cyl	1909-20	1 45	Nachor	1366	1	
5028	Spark plug wire, 7" No. 3 and 4 cyls.	1909-20	95	Nalad	1376	2	
5029	Spark plug wire terminal	1909-20	30	Nailer	1381	1	
5030	COMMUTATOR WIRE (non starter type)	1909-20	9 50	Nandu	7502	1	
5031	Commutator wire (starter type)	1919-20	9 50	Trifle	7502B	1	
5032	Com. wire terminal (coil end)	1909-20	10	Napher	1385	4	
5033	Com. wire loom support	1909-20	30	Napple	1390	2	
5034	Wire (ammeter to cut-out) Sedan 33"	1919	1 45	Topic	7683	1	
5035	Wire (ammeter to cut-out) Sedan 49"	1919-20	2 85	Topmast	7683B	1	
5036	Wire (ammeter to cut-out) Coupe 23"	1919	1 45	Torch	7684	1	
5037	Wire (ammeter to cut-out) Coupe 41"	1919-20	1 90	Rabid	7684B	1	
5038	Wire (ammeter to ignition switch)	1919-20	95	Torpid	7681	1	
5039	Wire (generator to cut-out)	1919	1 45	Trash	7687	1	
5040	Wire (terminal block to switch)	1919-20	95	Trench	8894B	1	
5041	Wire (lighting)	1919-20	14 25	Tromp	7682B	1	
5042	Wire (switch) Sedan	1919-20	7 60	Troth	7685B	1	
5043	Wire (switch) Coupe	1919-20	6 65	Truce	7686B	1	
5044	Block (terminal)	1919-20	1 45	Teller	1950	1	
5045	Screw (terminal block to dash)	1919-20	10	Tocsin	2073	2	
5046	Cable (battery to switch) 28 ¹ / ₄ "	1919-20	8 55	Tepor	1889B	1	
5047	Cable (battery to switch) 34"	1920	9 50	Pantry	1889C	1	
5048	Cable (ground) 20"	1919	6 65	Terse	1890	1	
5049	Cable (ground) 9 ⁵ / ₁₆ "	1919-20	4 75	Testa	1890B	1	
5050	Cable (ground) 11 ¹ / ₂ "	1920	4 75	Parish	1890C	1	
5051	Cable (switch to motor)	1919-20	7 15	Tether	1891	1	
5052	Bolt and nut (battery cable terminal)	1919-20	95	Temple	1937-1938	2	
AUTOMAT=AFBRYDER							
5054	Cut-out (electric) (dash type)	1919	14 25	Tenant	7677	1	
5055	Cut-out (electric)	1919-20	16 65	Tendril	7677B	1	
STARTDELE							
5056	Gasket (motor mounting)	1919-20	20	Theme	1768	1	
5057	Gasket (gen. head)	1919-20	20	Thane	1774	1	
5058	Screw (gen mounting, short)	1919-20	30	Thrack	1755	1	
5059	Screw (Bendix cover)	1919-20	10	Thrave	1765	1	
5060	Screw (term. block to wire)	1919-20 doz.	50	Thwack	2015	1	
5061	Screw (ammeter to plate)	1919-20	10	Thwart	2062	1	
5062	Screw (motor mounting)	1919-20	30	Thymet	1760	1	

Del No.	Navn paa Del	Aar	Pris	Kode Ord	Fabr. No	Ant. Stk. pr Vogn	Pragt Vægt
STARTMOTOR MED TILHØRENDE DELE			Kr.				
5099	Motor (starting)	1919-20	209 00	Tidbit	1877		
5100	Armature	1919-20	85 50	Tabid	1940		
5101	Band (cover)	1919-20	2 40	Tallage	1801		
5102	Bracket (brush end)	1919-20	8 55	Talmen	1868		
5103	Bracket assem. (mounting)	1919-20	23 75	Tawny	2037		
5104	Brush	1919-20	4 75	Tanvat	1806		
5105	Bushing (shaft, rear)	1919-20	3 80	Tapnet	1759		
5106	Bushing (shaft, front)	1919-20	1 90	Tapster	1789		
5107	Coil assembly (field)	1919-20	23 75	Targum	1871		
5108	Holder assem. (brush)	1919-20	6 65	Talpa	1864B		
5109	Insulator (terminal outer)	1919-20	95	Talus	1795		
*5110	Insulator (terminal inner)	1919-20	20	Tambac	1794		
5112	Nut (terminal)	1919-20	30	Tambour	1791		
*5113	Screw (field)	1919-20	20	Tamis	1788		
*5114	Screw (brush end bracket to yoke)	1919-20 doz.	50	Tamkin	1808		
5115	Spring (brush tension)	1919-20	50	Tampon	1809		
5116	Washer (terminal)	1919-20	20	Tarras	1792		
5117	Washer (terminal, inner, steel)	1919-20	20	Tarsic	1798		
5118	Yoke (motor) assembly	1919-20	66 50	Tartly	1852		

DYNAMO MED TILHØRENDE DELE

5119	Generator	1919-20	209 00	Tetter	1879		
5120	Armature (less bearings)	1919-20	87 90	Tanling	1925		
5121	Bearing (small)	1919-20	14 25	Tannic	1858		
5122	Bearing (large)	1919-20	16 65	Tantrum	1841		
5123	Bolt (terminal)	1919-20	30	Tegmen	1836		
5124	Bracket (brush end)	1919-20	10 45	Telary	1894		
5125	Brush (large)	1919-20	2 40	Tempean	1844		
5126	Brush (small)	1919-20	1 90	Tempter	1845		
5127	Disc (large bearing)	1919-20	30	Tendry	1847		
5128	Felt (small bearing)	1919-20	30	Tenter	2033		
5130	Head	1919-20	10 45	Tercol	2044		
5131	Holder (small brush)	1919-20	1 90	Termor	1821		
5132	Holder assem. (brush)	1919-20	5 70	Ternate	1920		
5133	Insulator (terminal, outer)	1919-20	95	Terras	1827		
5134	Nut (terminal)	1919-20	30	Tiling	1818		
5135	Oiler	1919-20	95	Testern	1857		
5136	Pin (pinion to shaft)	1919-20 doz.	50		1750		
5137	Pinion	1919-20	7 60	Throng	1752		
5138	Retainer (small bearing felt)	1919-20	20	Theban	1832		
5139	Spring (large brush)	1919-20	50	Theist	1967		
5140	Spring (small brush)	1919-20	50	Theimis	1988		
5141	Stud (small brush holder)	1919-20	50	Theon	1823B		
5142	Washer (terminal)	1919-20	20	Thermal	1831		
5143	Winding assembly (field)	1919-20	21 40	Tholus	1978		
5144	Wire (brush to terminal)	1919-20	75	Thorp	1851		
5145	Yoke (generator) assembly	1919-20	61 75	Thorite	1887		

BATTERIKURVE MED TILHØRENDE DELE

5150	Bracket assem.	1919-20	11 90	Tattoo	8841		
5151	Bolt and nut (clamp)	1919-20	95	Tetra	8846-29		
5152	Clamp	1919-20	95	Tetrad	8844		

*Ogsaa for Dynamo.

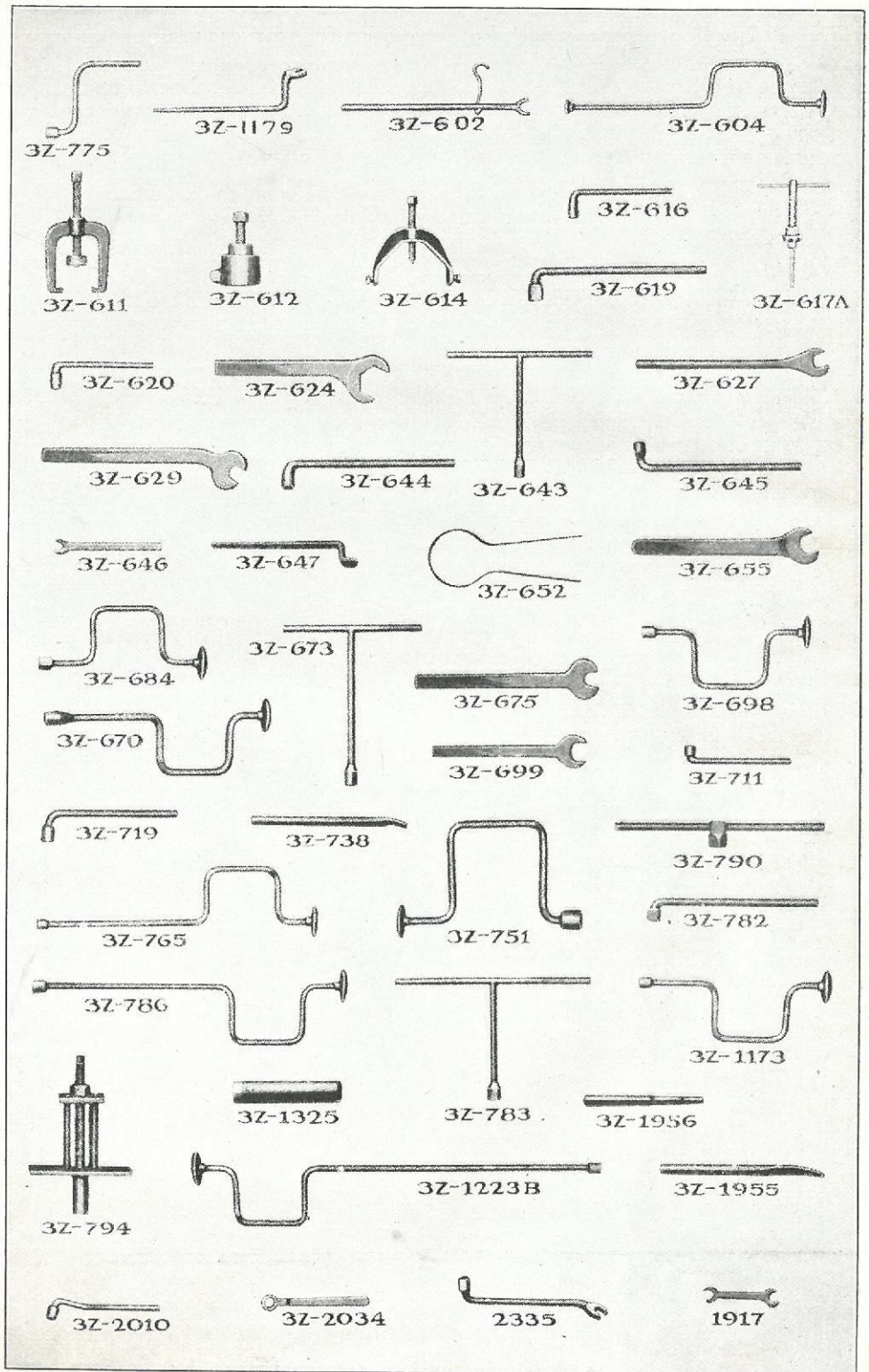

Del No.	Navn paa Del	Aar	Specifikationer	Pris	Kode Ord	Fabr. No.	Ant.Stk. pr Vogn	Fragt Vægt
REPARATIONSVÆRKTØJ				Kr.				
1349.	Hub cap wrench		Regular equipment	1 90.	Pacal	1349.		
1387.	Adjustable wrench		Regular equipment	5 50.	Pacos	1387.		
1902.	Screw driver		Regular equipment	4 75.	Padan	1902.		
1903.	Pliers		Regular equipment	4 75.	Paddy	1903.		
1917.	Double end wrench		Regular equipment	2 40.	Pagan	1917.		
2355.	Spark plug and cyl. head bolt wrench.		Regular equipment	4 75.	Pavid	5895.		
2356.	Tool roll		Regular equipment	5 50.	Pawky	1979.		
2337.	Oil can		Regular equipment	3 80.	Paxos	1384.		
2338.	Tire pump		Regular equipment	19 00.	Paysert	1368.		
2340.	Tire irons, each		Regular equipment	1 45.	Pelage	4069.		
2343.	Jack		Regular equipment	19 00.	Poser	5389.	1	
3Z-775.	$\frac{3}{8}$ " socket wrench		$8\frac{1}{16}$ " long	5 70.	Pallah			
3Z-1179.	Fly wheel cap screw wrench		$13\frac{1}{8}$ " long	11 90.	Palmy			
3Z-4730.	Valve spring litter		15" long	4 75.	Palpus			
3Z-703.	Tire iron (large)			5 70.	Pathos			
3Z-604.	Valve grinder			9 50.	Palster			
3Z-612.	Rear wheel puller assembly			14 25.	Panary			
3Z-611.	Small time gear puller			21 40.	Pantile			
3Z-614.	Transmission clutch puller			11 90.	Papaw			
3Z-620.	Drive shaft housing stud nut wrench for $\frac{11}{16}$ " nut			4 75.	Parent			
3Z-616.	Rear axle housing bolt nut wrench		$7\frac{3}{16}$ " long	4 75.	Parvis			
3Z-617-1.	Valve seat reamer		$7\frac{1}{8}$ " long	26 15.	Papula			
3Z-617-2.	Valve seat reamer cutter			17 60.	Papur			
3Z-617-3.	Valve seat reamer handle			14 25.	Pasha			
3Z-643.	$\frac{3}{8}$ " T socket wrench		$9\frac{1}{4}$ " long	7 15.	Parfit			
3Z-644.	Socket wrench for crank shaft bearing bolt nut		$12\frac{1}{32}$ " long	6 65.	Passim			
3Z-645.	$\frac{3}{8}$ " L socket wrench		12"	5 70.	Pastel			
3Z-646.	$\frac{3}{8}$ " open end wrench		$7\frac{1}{8}$ " long	2 85.	Pastor			
3Z-647.	Connecting rod clamp screw wrench		$10\frac{1}{4}$ " long	7 15.	Parrot			
3Z-1223B.	$\frac{3}{16}$ " brace socket wrench		$24\frac{1}{8}$ " long	9 50.	Parsec			
3Z-652.	Piston ring squeezer		$3\frac{7}{8}$ " dia	2 85.	Patile			
3Z-655.	Large cam gear lock nut wrench		14" long	6 65.	Pavan			
3Z-619.	Crank shaft bearing bolt wrench		Oval head	5 70.	Pelox			
3Z-782.	Crank shaft bearing bolt wrench		Square head	4 75.	Poloy			
3Z-2034.	Trans hand ratchet wrench			6 65.	Poplin			
3Z-675.	Rear axle nut open end wrench			9 50.	Porite			
3Z-624.	Exhaust pack nut open end wrench			11 90.	Potash			
3Z-627.	Rear axle entering wrench			7 15.	Potion			
3Z-673.	Body bracket connecting bolt T wrench, front and center			9 50.	Prater			
3Z-686.	Body bracket connecting bolt holding open end wrench			3 80.	Preen			
3Z-698.	{ Cylinder water outlet connecting screw brace wrench } { Brake shoe support bolt brace wrench } { D/S bearing housing screw brace wrench }			22 80.	Prince	pr. Stk. 7 60		
3Z-699.	Spindle cone adjusting open end wrench			4 75.	Profile			
3Z-719.	Body bracket connecting bolt R. & L wrench			6 20.	Proverb			
3Z-738.	Riveting bar for starting crank ratchet pin			5 70.	Prude			
3Z-751.	Rear axle nut and housing plug brace wrench			11 90.	Pulpit			
3Z-1173.	Front radius rod ball cap screw brace wrench			9 50.	Pumice			
3Z-786.	Cylinder head cap screw brace wrench			9 50.	Pusil			
3Z-790.	Drive shaft pinion T wrench			9 50.	Puzzle			
3Z-783.	Connecting rod T wrench			8 55.	Pygmy			
3Z-1956.	Spindle arm bushing driver			8 55.	Quinsky			
3Z-2010.	Connecting rod cap bolt nut L wrench (Cylinder No. 4)			4 75.	Quack			
3Z-2304.	Connecting rod cap bolt nut brace wrench with universal joint for No. 4 connecting rod			23 75.	Quadra			
3Z-4157.	Generator third brush adjusting wrench			2 85.	Quaver			
3Z-4712.	Bendix shaft head puller			14 25.	Queach			
16Z-4992.	Large time gear puller			104 50.	Queasy			

REPARATIONSVÆRKTØJ—LASTAUTOMOBILER

3Z-2257.	Rear wheel puller assembly			14 25.	Hock			
3Z-711.	Rear axle housing bolt L socket wrench			4 75.	Prosy			
3389X.	Jack			28 50.	Hog			

SPLITTER

	Fac. No.		Fac. No.
$\frac{3}{32}$ " x 1" cotter pins	421	$\frac{5}{16}$ " x $\frac{1}{2}$ " cotter pins	66
$\frac{3}{32}$ " x $\frac{3}{4}$ " cotter pins	753	$\frac{1}{16}$ " x $\frac{1}{2}$ " cotter pins	544
$\frac{1}{8}$ " x 1" cotter pins	82	$\frac{3}{16}$ " x $\frac{3}{8}$ " cotter pins	88
Price, per dozen			Kr. 50
Price, per gross			— 2 40

MØTRIKER

$\frac{3}{8}$ "—24 tds			30
Denne Størrelse af Møtrik brugt paa følgende Dele: 2514, 2722, 2729B, 3073, 3074, 3362, 3437, 3443, 2514B, 2741, 3010, 4041, 4808, 4808B.			

Forlang at faa ægte Ford Dele

Prisliste over Reservedele og Tilbehør

Del No.	Navn paa Del	Fabrikat	Aar	Kode	Pris
ELEKTRISKE HORN					
6432X	Electric horn complete			Ulcer	23 75
7915X	Electric horn terminal wire 9"			Ulna	50
7917X	Electric horn to switch wire 35 1/4"			Ultra	1 45
8028X	Horn switch assembly		1919-20	Valiant	2 85
ELEKTRISKE FORLAMPER (STANDARD 1915-20)					
6511BX	Head lamp assembly—used with dimmer on magneto current (when used on magneto current without dimmer use T 6572X bulb) per pair			Unific	76 00
6511CX	Head lamp assembly—two bulb type—per pair			Unport	76 00
6511D	Head lamp assembly—with "Tu-Lite" bulb per pair			Unalist	76 00
6594X	Head lamp door assembly			Union	9 50
6589X	Head lamp switch assembly—with screws			Ural	3 35
8650X	Head lamp and horn switch assembly			Urith	3 80
8892X	Dimmer resistance coil with wires			Urbox	6 65
6572X	Head lamp bulb—double cont. used with magn. without dimmer	1915-18		Urban	4 75
6572BX	Head lamp bulb—double contact—used with dimmer without starter, or with resistance coil with starter	1918-20		Uraca	4 75
6572CX	Head lamp bulb—single contact—used with storage batteries	1918-20		Urcan	4 75
6572DX	Head lamp bulb "Tu-Lite" double filament			Urgia	7 15
6520X	Dimmer bulb (for head and tail lamp) single contact	1919-20		Vamos	2 65
6578X	Head lamp door lens gasket			Urchin	50
6576X	Head lamp door lens—8 1/4"			Urn	2 40
6592X	Head lamp plug—with thimble			Urus	1 90
6585X	Head lamp reflector			Urva	11 40
6585BX	Head lamp reflector (dimmer type)	1919-20		Urbus	11 40
6577X	Head lamp door lens retainer			Usher	50
6580X	Head lamp focusing screw			Utas	50
6591X	Head lamp focusing screw spring			Ute	30
6574X	Head lamp bulb socket			Vagrant	1 90
6586X	Head lamp reflector spring			Vail	90
7487X	Switch to terminal wire—1 3/4" long			Valise	50
7489X	Lamp to lamp wire—40" long			Vallum	1 45
7490X	Lamp to ground wire—10 3/4" long			Vamp	50
SIDE OG BAG-OLIELAMPER—1915-20					
6561X	Side oil lamp per pair			Van	28 50
6568X	Tail lamp			Vandal	23 75
7669X	Electric tail lamp assembly	1919-20		Vanquish	11 90
6484BX	Electric tail lamp red lens	1919-20		Vales	1 45
6495X	Electric tail lamp bulb socket	1919-20		Valgus	3 35
6599X	Side oil and tail lamp fount			Vane	4 75
6956X	Side oil lamp door			Vanish	4 75
6957X	Tail lamp door			Vapid	4 75
6966X	Tail lamp white lens and frame			Vapor	1 90
6460X	Lamp burner including wick			Varix	2 85
6958X	Lamp chimney case			Varus	2 85
6472X	Lamp chimney			Vase	2 85
6959X	Lamp chimney cover			Vassal	2 40
6483X	Side oil lamp door lens			Vat	1 45
6484X	Tail lamp door red lens			Vault	1 45
6393X	Side oil lamp to bracket bolt nut			Veal	30
6486X	Lamp door hinge pin			Veer	50
6392X	Lamp wick			Vega	50
TOURING VOGN OG TORPEDO VINDSKÆRME—1915-20					
*7840X	Windshield assembly, less brackets, bolts, nuts and washers			Vender	171 00
7818BX	Windshield hinge assembly—Right	1917-20		Vent	4 30
7819BX	Windshield hinge assembly—Left	1917-20		Verb	4 30
7820AX	Windshield upper frame assembly	1915-16		Verge	14 25
7820BX	Windshield frame assembly—upper	1917-20		Vermin	14 25
7822AX	Windshield upper half assembly	1915-16		Verse	71 25
7822BX	Windshield upper half assembly	1917-20		Verst	71 25
7823X	Windshield lower half assembly	1915-20		Vertex	83 15
7802X	Windshield lower frame only	1915-20		Venge	11 40
7803X	Windshield lower frame filler block	1915-20		Verve	1 90
7839X	Windshield frame filler block			Vervet	1 45
7888X	Windshield block (frame filler)—upper	1917		Vesper	1 45
7810X	Windshield hinge bolt			Vespid	50
7845X	Windshield bracket—right	1915-19		Vestal	7 15
7845B	Windshield bracket—right	1919-20		Vestado	7 15
7846X	Windshield bracket—left	1915-19		Vestry	7 15
7846B	Windshield bracket—left	1919-20		Vexil	7 15
7824X	Windshield glass clamp			Veto	50
7801X	Windshield frame—upper	1915-16		Vial	8 55
7887X	Windshield frame—upper	1917-20		Vicar	8 55
7890X	Windshield hinge—lower left	1917-20		View	1 45
7805X	Windshield left hand upper hinge			Viking	1 45
7889X	Windshield hinge—lower right	1917-20		Vim	1 90
7807X	Windshield right hand upper hinge			Vina	1 45
3827X	Windshield top snap loop			Vine	50
1154X	Windshield hinge bolt nuts			Vintage	50
2449BX	Windshield glass clamp screw			Viol	10
2257BX	Windshield hinge to frame screw (Order 3367)				
6013X	Windshield hinge spring			Virgin	30
7851X	Windshield upper glass stop—nickel	1915-20		Vise	3 35
7852X	Windshield lower glass stop—nickel	1915-20		Vitals	3 35
7808X	Windshield hinge thimble			Vitex	50

Forlang at faa ægte Ford Dele

*Bestil 7846X-7845X ekstra til 1915-16 Vogn

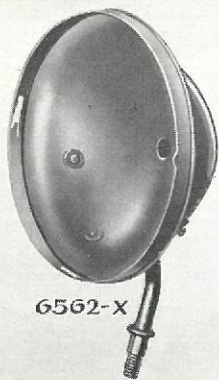

6562-X

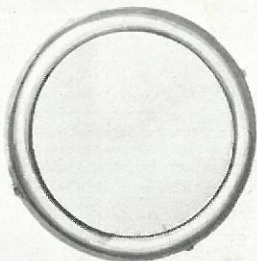

6594-X



6511-X

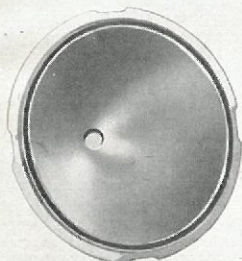

6585-X

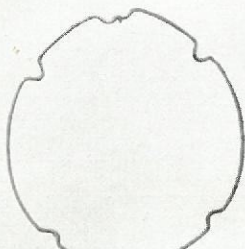

6586-X

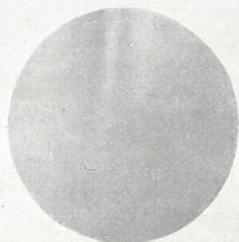

6576-X



7490-X

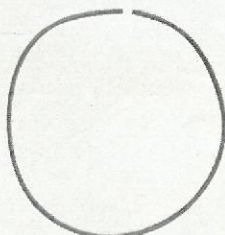

6578-X



7487-A X



8650-X



7489-X



6572-X



8894-X



6592-X

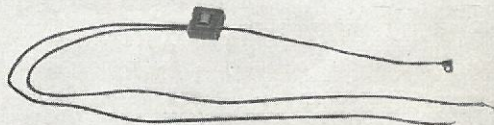

8892-X



6574-X

Del No.	Navn paa Del	Fabrikat	Aar	Kode	Pris
TOURING VOGN KALESCE—1915-20					Kr.
7940X	Touring car top complete.		1915-20	Warm	
6882X	Touring car storm curtain (R. H.)		1915-20	Warm	26 15
6883X	Touring car storm curtain (L. H.)		1915-20	Warm	26 15
4966BX	Touring car side curtain (R. H.)		1915-20	Warm	33 25
4967BX	Touring car side curtain (L. H.)		1915-20	Warm	33 25
6894X	Touring car center deck complete		1915-20	Wasp	114 00
6886X	Touring car center deck only 91½" x 50"		1915-20	Waste	47 50
6895X	Touring car side quarter (R. H.)		1915-20	Watch	19 00
6896X	Touring car side quarter (L. H.)		1915-20	Water	19 00
6815X	Touring car side quarter pad.		1915-20	Watt	14 25
6940X	Touring car back stay and curtain assembly		1915-20	Wax	33 25
6866X	Touring car wood bow (1st)		1915-17	Weak	14 25
3897X	Touring car wood bow (2nd and 3rd)		1913-17	Weapon	14 25
4957X	Touring car wood bow—rear		1914-17	Web	14 25
8973X	Touring car front and rear extension rib		1918-20	Yawn	3 80
8974X	Touring car front and rear upright rib		1918-20	Yell	3 80
4596X	Touring car bow separator—male		1913-17	Wedge	50
4597X	Touring car bow separator—female		1913-17	Weed	50
6832X	Touring car bow separator		1918-20	Welp	50
6860AX	Touring car front extension bow socket (R. H.)		1915-17	Weep	11 90
6860BX	Touring car front extension bow socket (R. H.)		1918-20	Wealth	11 90
6861AX	Touring car front extension bow socket (L. H.)		1915-17	Weir	11 90
6861BX	Touring car front extension bow socket (L. H.)		1918-20	Weary	11 90
3884AX	Touring car rear extension bow socket (R. H.)		1913-17	Weld	11 90
3884BX	Touring car rear extension bow socket (R. H.)		1918-20	Wedding	11 90
3885AX	Touring car rear extension bow socket (L. H.)		1913-17	Welkin	11 90
3885BX	Touring car rear extension bow socket (L. H.)		1918-20	Welt	11 90
6862AX	Touring car front upright bow socket (R. H.)		1915-17	Well	11 90
6862BX	Touring car front upright bow socket (R. H.)		1918-20	Whig	11 90
6863AX	Touring car front upright bow socket (L. H.)		1915-17	Welsh	11 90
6863BX	Touring car front upright bow socket (L. H.)		1918-20	Whilk	11 90
3882AX	Touring car rear upright bow socket (R. H.)		1913-17	West	11 90
3882BX	Touring car rear upright bow socket (R. H.)		1918-20	Yauk	11 90
3883AX	Touring car rear upright bow socket (L. H.)		1913-17	Wether	11 90
3883BX	Touring car rear upright bow socket (L. H.)		1918-20	Yawl	11 90
7831X	Curtain to windshield hook		1915-20	Whame	30
7832X	Curtain to body hook		1915-20	Whaul	30
6837X	Touring car key strap assembly		1913-18	Whale	50
8992X	Rib socket cotter		1918-20	Wheeze	50
3924X	Touring car top to windshield strap assembly		1915-20	Wharf	2 85
3629X	Touring car rear stay strap assembly complete		1913-20	Wheat	5 25
3631X	Touring car rear stay strap—short—lower		1913-20	Whiff	2 40
3632X	Touring car rear stay strap—long—upper		1913-20	Whim	2 85
6925X	Touring car curtain to windshield strap assembly		1915-19	Whine	95
6926X	Touring car curtain to lamp bracket strap assembly		1915-19	Whip	95
3754X	Touring car curtain glove fastener assembly		1913-20	Whist	95
6829AX	Touring car duquesne clip—upper		1914-17	Whoop	95
6829BX	Touring car extension support—upper		1918-20	Yelk	95
6830AX	Touring car duquesne clip—lower		1914-17	Wick	95
6830BX	Touring car extension support—lower		1918-20	Yeoman	50
3316X	Touring car top brass fastener—single		1913-16	Widow	50
3549X	Touring car top brass fastener—double		1913-16	Wife	50
8957X	Touring car top snap fastener—single		1917-20	Wig	55
8958X	Touring car top snap fastener—double		1917-20	Willow	55
3314X	Touring car top prop rest with strap		1913-20	Wind	5 70
3858X	Touring car top prop rest arm		1913-20	Wine	2 40
3624X	Touring car bow socket to seat iron japanned nut		1913-20	Wing	50
3383X	Curtain celluloid 20" x 36"—.015 thick		1913-20	Wink	19 00
3383X	Curtain celluloid 10" x 18"—.015 thick		1913-20	Winter	4 75
6881X	Touring car top dust hood		1915-20	Wire	33 25
4981X	Touring car top visor		1920	Wizen	7 15

TORPEDO KALESCEDELE—1915-20

*7941X	Torpedo top complete		1915-20	Wisdom	
4971X	Torpedo top—second and third wood bows		1914-18	Wish	4 75
6929X	Torpedo top—first bow		1915-18	Wisp	4 75
8772X	Rib—upright		1918-20	Wenny	3 80
8988X	Rib—front extension		1918-20	Wcpt	3 80
8989X	Rib—rear extension		1918-20	Westing	3 80
6870X	Torpedo top bow socket—upright—(R. H.)		1915-18	Wich	11 90
6871X	Torpedo top bow socket—upright—(L. H.)		1915-18	Withe	11 90
6873X	Torpedo top bow socket—front extension—(L. H.)		1915-18	Witness	9 50
6872	Torpedo top bow socket—front extension—(R. H.)		1915-18	Wizard	9 50
4907X	Torpedo top bow socket—rear extension—(R. H.)		1913-18	Wolf	9 50
4908X	Torpedo top bow socket—rear extension—(L. H.)		1913-18	Woman	9 50
6937X	Torpedo top side curtain—rear—(R. H.)		1915-20	Wood	19 00
6938X	Torpedo top side curtain—rear—(L. H.)		1915-20	Word	19 00
6935X	Torpedo top side curtain—front—(R. H.)		1915-20	Work	23 75
6936X	Torpedo top side curtain—front—(L. H.)		1915-20	World	23 75
6950X	Torpedo top back curtain assembly		1915-20	Worm	28 50
6965X	Torpedo top center deck complete		1915-20	Worry	71 25
6964X	Torpedo top deck only		1915-20	Wrap	26 60
6962X	Torpedo top side quarter—(R. H.)		1915-20	Wreck	11 90
6963X	Torpedo top side quarter—(L. H.)		1915-20	Wren	11 90
8806X	Torpedo top side quarter pad		1914-20	Wrist	9 50
6939X	Torpedo top hood		1915-20	Yak	31 35
3877X	Torpedo top prop rest with strap		1913-20	Yam	5 70
4955X	Torpedo top visor		1920	Yamper	7 15

Forlang at faa ægte Ford Dele

*Forespørg Filial og Forhandler om Pris.

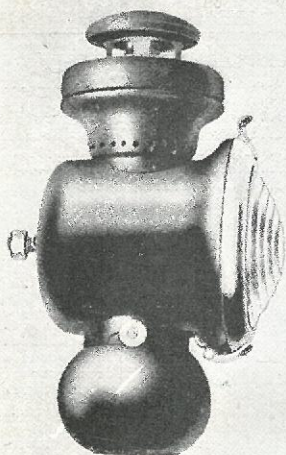

6561

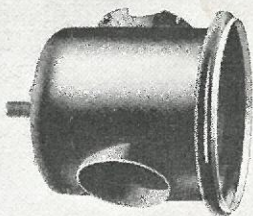

6456

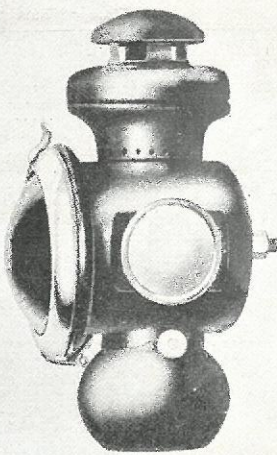

6568



6956

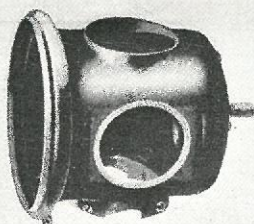

6458



6957



6472



6460



6478



6966

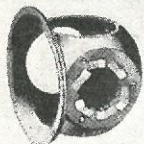

6490



7922



6959



6492



6958



1154



6486



6599

Prisliste over Reservedele til 1 Ton Lastbil, Model T

Del No.	Navn paa Del	Aar	Pris	Kode Ord	Model	Fabr. No.	Ant. Stk. pr. Vogn
BAGAKSEL			Kr.				
1000	Rear axle assembly	1918-20	1900 00	Abed	TT	95	1
1001	Axle housing—right	1918-20	237 50	Abys	TT	4	1
1002	Axle housing—left	1918-20	237 50	Acme	TT	5	1
1003	Axle housing bolt and nut	1918-20	95	Acorn	TT	52-T220	13
1004	Axle housing cap	1918-20	4 75	Actor	TT	133	1
1005	Axle housing cap gasket	1918-20	20	Acute	TT	134	1
1006	Axle housing cap screw	1918-20	95	Adder	TT	72	4
1007	Axle housing cap screw lock wire	1918-20	20	Addle	TT	140	1
1008	Axle housing gasket—upper	1918-20	20	Agate	TT	138	1
1009	Axle housing gasket—lower	1918-20	55	Agast	TT	139	1
1010	Axle brake housing plate—right	1918-20	4 75	Agile	TT	147	1
1011	Axle brake housing plate—left	1918-20	4 75	Akin	TT	148	1
1012	Axle housing drain plug	1918-20	50	Alder	TT	136	2
1013	Axle shaft and nut	1918-20	67 95	Alex	TT	48	2
1014	Axle shaft cotter	1918-20	10	Alms	TT	165	2
1015	Axle shaft nut	1918-20	1 45	Aloe	TT	166	2
1016	Axle shaft washer	1918-20	50	Aloft	TT	135	2
1017	Axle shaft dust cap	1918-20	50	Alpha	TT	56	2
1018	Axle shaft inner ball bearing assembly	1918-20	61 75	Alpine	TT	125	2
1019	Axle shaft outer roller bearing	1918-20	19 00	Archer	TT	171	2
1020	Axle shaft outer roller bearing sleeve	1918-20	5 70	Arena	TT	170	2
1021	Axle shaft bearing felt	1918-20	1 45	Argue	TT	143	4
1022	Axle shaft bearing retainer	1918-20	1 45	Ark	TT	20	2
1023	Axle shaft bearing retainer washer	1918-20	50	Arson	TT	23	2
1024	Axle shaft felt retainer assembly	1918-20	1 90	Astral	TT	144	2
1025	Axle shaft felt retainer cup	1918-20	50	Atwist	TT	145	2
1026	Axle shaft felt retainer plate	1918-20	50	Atoll	TT	146	2
1027	Diff. gear	1918-20	28 50	Aura	TT	13	2
1028	Diff. gear case R. or L. half	1918-20	28 50	Author	TT	11	2
1029	Diff. gear case bolt	1918-20	50	Avail	TT	52	8
1030	Order T2719						
1031	Diff. gear lock ring	1918-20	50	Avoke	TT	118	2
1032	Diff. pinion	1918-20	9 50	Awake	TT	14	2
1033	Diff. pinion shaft	1918-20	3 80	Awry	TT	15	1
1034	Drive shaft	1918-20	95 00	Bait	TT	87	1
1036	D. S. tube assembly	1918-20	142 50	Balm	TT	153	1
1037	D. S. tube flange gasket	1918-20	20	Bandit	TT	194	1
1038	D. S. tube flange screw	Order 1006					
1039	D. S. felt	1918-20	95	Basil	TT	109	1
1040	D. S. felt container	1918-20	50	Beaver	TT	110	1
1041A	D. S. to worm coupling	1918-19	14 25	Behind	TT	85	1
1041B	D. S. to worm coupling	1920	14 25	Bhang	TT	85B	1
1042	D. S. to worm coupling pin	1918-20	30	Behold	TT	86	2
1043	Worm	1918-20	171 00	Berg	TT	16	1
1044	Worm gear	1918-20	190 00	Bible	TT	12	1
1045	Worm cotter, Order 1014	1918-20					
1046	Worm roller bearing	1918-20	14 25	Bight	TT	108	2
1047	Worm roller bearing retainer	1918-20	95	Bigot	TT	106	1
1048	Worm roller bearing sleeve	1918-20	19 00	Bilog	TT	107	2
1049	Worm roller bearing housing screw	1918-20	95	Birch	TT	101	2
1050	Worm thrust bearing collar	1918-20	14 25	Bird	TT	114	2
1051	Worm thrust ball and separator assembly	1918-20	14 25	Bitter	TT	123	1
1052	Worm thrust bearing plate	1918-20	1 45	Blaze	TT	22	1
1053	Worm thrust bearing retainer	1918-20	5 70	Bleach	TT	111	1
1054	Worm thrust bearing retainer nut	Order 1015					
1055	Worm thrust bearing retainer pin	1918-20	30	Blend	TT	112	1
1056	Brake shoe	1918-20	23 75	Blind	TT	2814	2
1057	Brake shoe lining, each	1918-20	3 80	Blink	TT	58	4
1058	Brake shoe lining rivet	1918-20	30	Blue	TT	68	40
1059	Brake shoe spring	1918-20	95	Blunt	TT	67	2
1060	Brake shoe bolt and nut	1918-20	2 85	Blush	TT	59-T242	2
1061	Brake expander	1918-20	7 60	Bodkin	TT	61	2
1062	Brake expander lever	1918-20	1 90	Booth	TT	62	2
1064	Brake expander adjustment collar	1918-20	2 85	Brig	TT	175	2
1065	Brake expander bushing	1918-20	1 45	Bronze	TT	173	2
1066	Brake expander pin	1918-20	30	Brook	TT	7	2
1067	Brake expander link	1918-20	50	Broom	TT	176	4
1068	Brake expander link pin	1918-20	30	Brow	TT	177	8
1069	Brake rod	1918-20	4 75	Brush	TT	119	2
1070	Brake rod support—right	1918-20	95	Buck	TT	120	1
1071	Brake rod support—left	1918-20	95	Bug	TT	121	1
1072	Brake rod support bolt and nut	1918-20	50	Buoy	TT	1308-T1309	2
1073	Rear radius rod	1918-20	57 00	Burn	TT	152	2
1074	Rear radius rod bolt and nut—front	1918-20	3 80	Crab	TT	84-T242	1
1075	Rear radius rod bolt and nut—rear	1918-20	2 85	Crag	TT	85-T242	4
1076	Universal joint bushing	1918-20	7 15	Crape	TT	69	1
FJEDER							
1077	Rear spring—right or left, each	1918-20	57 00	Cream	TT	333	2
1078	Spring leaf No. 1	1918-20	11 40	Creed	TT	334	2
1079	Spring leaf No. 2	1918-20	8 55	Crew	TT	362	2
1080	Spring leaf No. 3	1918-20	7 15	Crib	TT	363	2
1081	Spring leaf No. 4	1918-20	6 65	Crisp	TT	364	2
1082	Spring leaf No. 5	1918-20	6 20	Croak	TT	365	2
1083	Spring leaf No. 6	1918-20	5 25	Crop	TT	366	2

Forlang at faa ægte Ford Dele

tk. gn
1
13
1
4
1
1
2
2
2
2
2
4
2
2
8
2
2
2
1
1
1
1
1
1
1
2
2
2
2
2
1
1
4
2
2
2
2
2
4
8
2
1
1
2
2
2
2
4
1
2
2
2
2
2
2

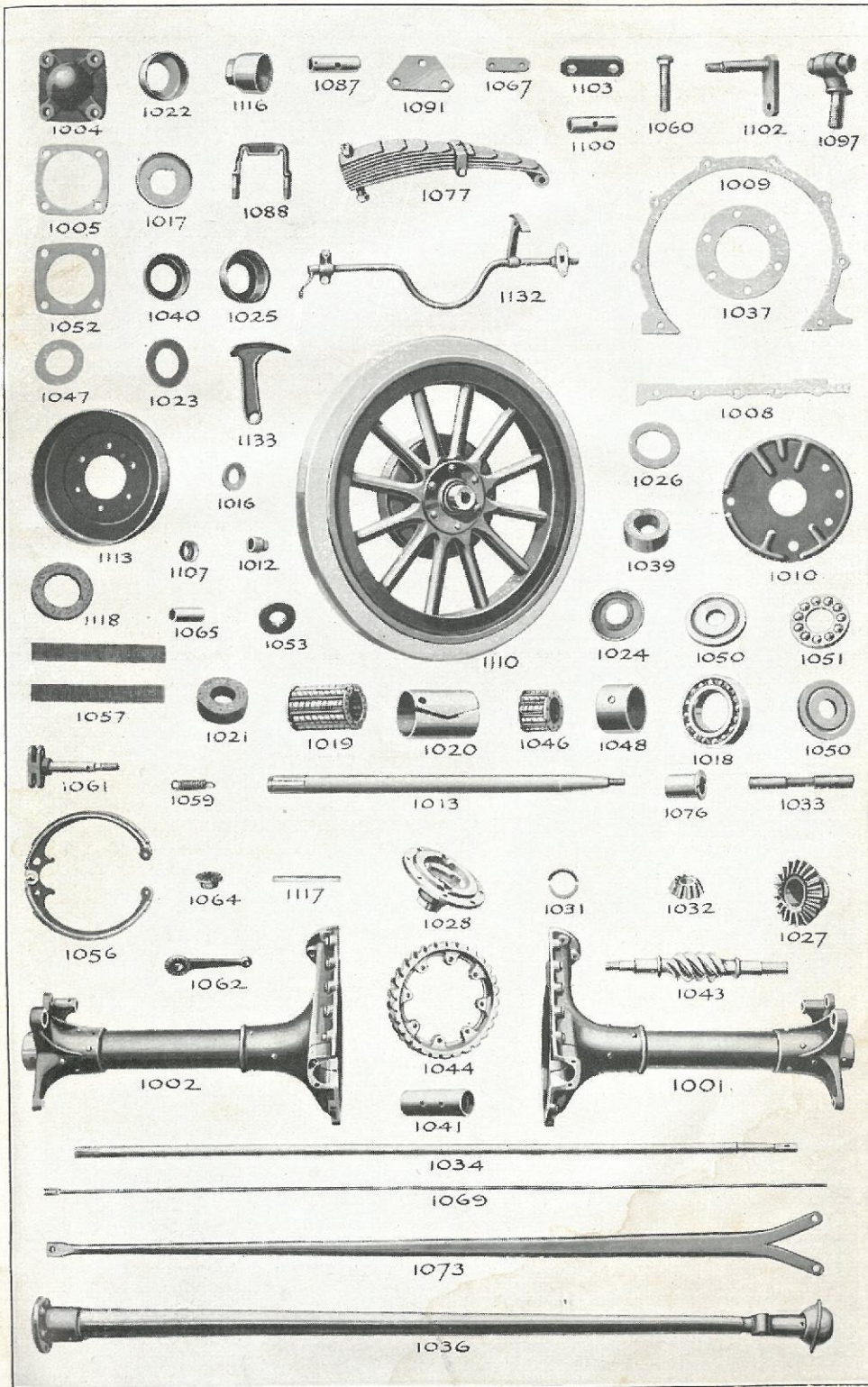

475
281
760

Del No.	Navn paa Del	Aar	Pris	Kode Ord	Model	Fabr. No.	Ant. Stk. pr. Vogn
FJEDER—Fortsat							
			Kr.				
1084	Spring leaf No. 7	1918-20	4 75	Croup	TT	367	2
1085	Spring leaf No. 8	1918-20	3 80	Crow	TT	368	2
1086	Spring leaf No. 9	1918-20	3 35	Crowd	TT	331	2
1087	Spring bushing	1918-20	1 90	Crumb	TT	332	2
1088	Spring clip	1918-20	5 70	Crusher	TT	326	2
1089	Spring clip nut	1918-20	1 45	Cry	TT	327	4
1091	Spring clip plate	1918-20	2 40	Cuff	TT	329	2
1092	Spring tie bolt	1918-20	3 35	Cult	TT	330	2
1093	Spring tie bolt nut. Order 1089	1918-20					
1094	Spring tie bolt cotter	1918-20	10	Cure	TT	328	2
1095	Spring clamp	1918-20	95	Curl	TT	375	2
1096	Spring clamp bolt and nut	1918-20	50	Curse	TT	376-1926	2
1097	Spring perch	1918-20	11 40	Dale	TT	2804	2
1098	Spring perch nut. Order 1015	1918-20					
1099	Spring perch cotter. Order 1014	1918-20					
1100	Spring perch bushing	1918-20	2 85	Demon	TT	172	2
1101	Spring perch bushing spacer	1918-20	50	Dean	TT	169	4
1102	Spring hanger assembly	1918-20	4 30	Dike	TT	91	4
HJUL							
1105B	Rear wheel complete (less tire) dem. Kelsey	Old No. 1109B	1919-20	237 50	Duelist	TT	7698
1105C	Rear wheel complete (less tire) dem. Hayes	Old No. 1109B	1919-20	237 50	Dulcant	TT	7698B
1106B	Dem. rim only—Kelsey	Old No. 1109C	1919-20	52 25	Duke	TT	8774
1106C	Dem. rim only—Hayes	Old No. 1109C	1919-20	52 25	Dumal	TT	8774B
1107B	Clamp and nut assembly— Kelsey	Old No. 1109D	1919-20	1 90	Duledge	TT	8807
1108B	Clamp bolt	Old No. 1109E	1919-20	95	Dullish	TT	8832
1109	Rear wheel complete, less tire	1918-19	171 00	Duel	TT	99	2
1110	Rear wheel complete, with solid tire	1918-19		Drone		7645	
1111	Rear hub	1918-20	42 75	Dumb	TT	40	2
1112	Rear hub flange	1918-20	5 70	Dusk	TT	149	2
1113	Rear hub brake drum	1918-20	19 00	Dutch	TT	3	2
1114	Rear hub bolt and nut	1918-20	95	Dwarf	TT	28-29	12
1116	Rear hub cap	1918-20	3 35	Dyke	TT	150	2
1117	Rear hub key	1918-20	95	Ear	TT	26	2
1118	Rear hub felt	1918-20	95	East	TT	162	2
RAMME							
1119	Frame assembly	1918-20	332 50	Eat	TT	300	1
1120	Side member—right	1918-20	114 00	Ebb	TT	301	1
1121	Side member—left	1918-20	114 00	Fish	TT	302	1
1122	Front cross member	1918-20	14 25	Flirt	TT	303	1
1123	Rear cross member	1918-20	57 00	Flock	TT	304	1
1124	Front corner bracket—right	1918-20	1 90	Frost	TT	305	1
1125	Front corner bracket—left	1918-20	1 90	Froth	TT	306	1
1125B	Front end spacer—right	1918-20	1 45	Fruitage	TT	319	1
1125C	Front end spacer—left	1918-20	1 45	Fruitful	TT	318	1
1126	Rear cross member gusset plate	1918-20	2 40	Ghost	TT	307	2
GEARREGULERING							
1133	Speed lever	1918-20	1 90	Hoe	TT	862	1
1134	Controlser shaft with speed lever	1918-20	7 15	Hod	TT	1557	1

ny
Stk.
ogn

. 2
. 2
. 2
. 2
. 2
. 4
. 2
. 2
. 2
. 2
. 2
. 2
. 2
. 2
. 2
. 2
. 4
. 4

.....
.....
.....
.....
.....
. 2
.....
. 2
. 2
. 2
. 2
. 12
. 2
. 2
. 2

. 1
. 1
. 1
. 1
. 1
. 1
. 1
. 1
. 1
. 2

. 1
. 1



2
sys