

THE JAGUAR 4.2 LITRE

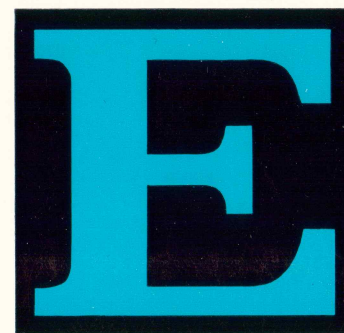

TYPE



THE 4.2 LITRE 'E' TYPE JAGUAR

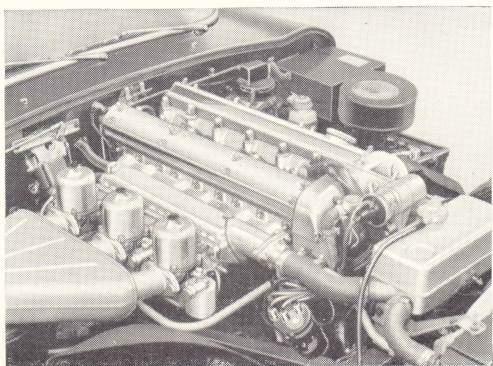

ADVANCED XK ENGINE

4.2 litre, 6 cylinder, twin overhead camshaft advanced design of race-proved 3 carburettor Jaguar XK engine, five times winner of Le Mans, gives higher torque for increased acceleration and flexibility.

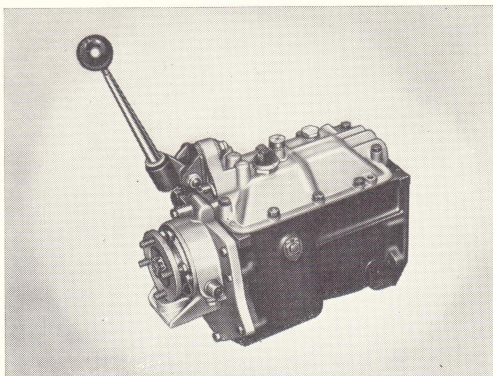

ALL SYNCHROMESH GEARBOX

Four-speed all synchro crash-proof transmission gives smooth, rapid changes. Diaphragm spring clutch gives lighter pedal pressure and long life.

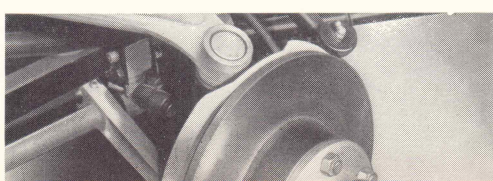

The Jaguar 'E' type is a unique combination of graceful styling, luxurious interiors, smooth unobtrusive high performance, all of which are the hallmarks of this, the world's most outstanding G.T. car. The 4.2 litre 'XK' engine is fitted as standard to all 'E' type models and provides outstanding acceleration and flexibility of performance throughout its very wide speed range. Each model features rich upholstery, fitted carpets, extensive safety padding, comprehensive instrumentation and fresh air heating and ventilation. Each model combines outstanding handling with the luxury of saloon car comfort — a special kind of motoring which no other car in the world can offer.

ALTERNATOR gives greatly increased current supply over wide range of engine speeds, ensuring adequate current supply—even with city driving—for the extensive electrical service embodied.

PRE-ENGAGED STARTER facilitates starting under conditions of extreme cold.

SHAPED SEATING designed for maximum comfort, and upholstered in finest quality Vaumol leather over Dunlopillo foam rubber cushions.



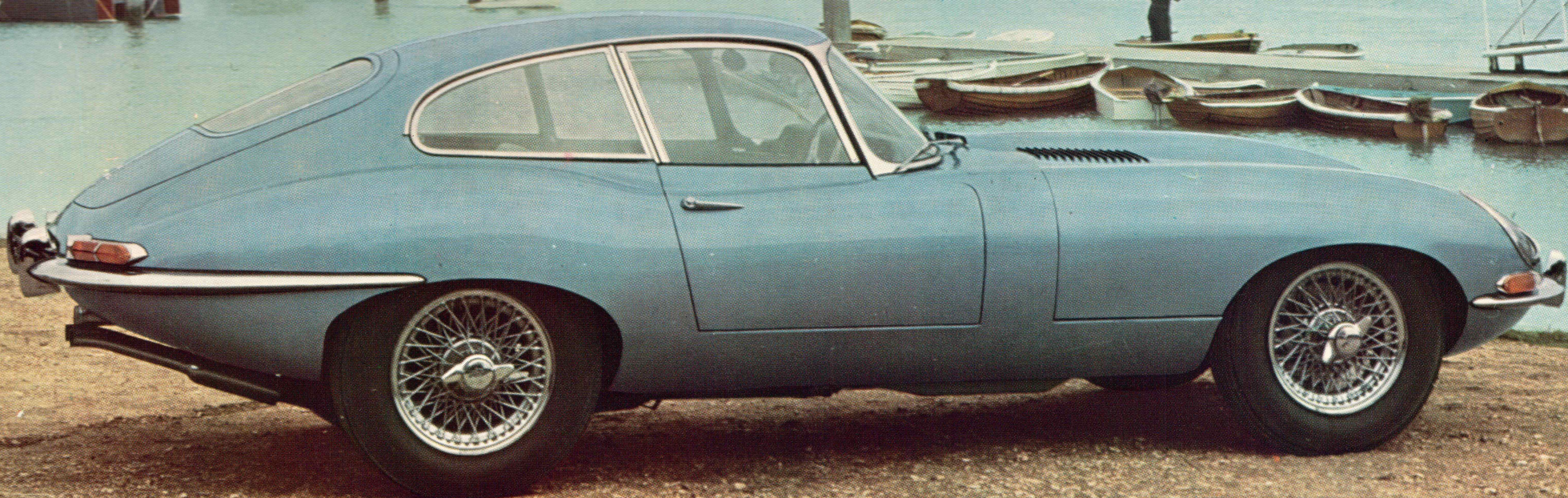

THE 4.2 LITRE 'E' TYPE JAGUAR

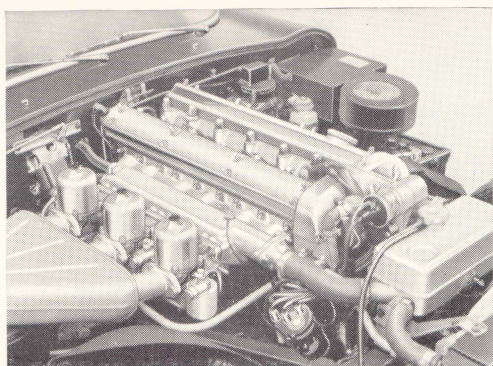

ADVANCED XK ENGINE

4.2 litre, 6 cylinder, twin overhead camshaft advanced design of race-proved 3 carburetter Jaguar XK engine, five times winner of Le Mans, gives higher torque for increased acceleration and flexibility.

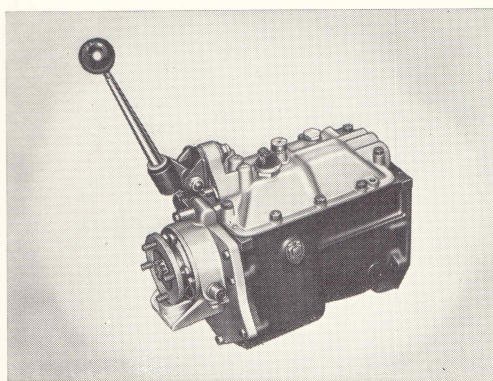

ALL SYNCHROMESH GEARBOX

Four-speed all synchro crash-proof transmission gives smooth, rapid changes. Diaphragm spring clutch gives lighter pedal pressure and long life.

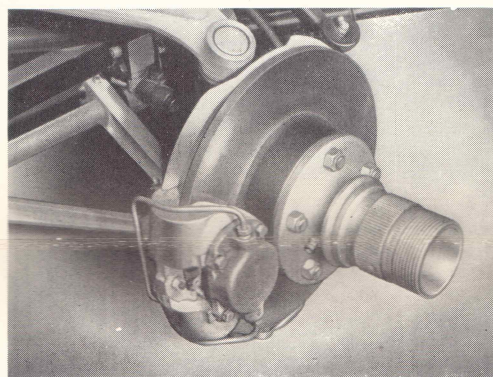

EFFORTLESS BRAKING

Brake servo gives lower effort and greater power for the disc brakes on all four wheels. Separate fluid systems for front and rear give added safety.

The Jaguar 'E' type is a unique combination of graceful styling, luxurious interiors, smooth unobtrusive high performance, all of which are the hallmarks of this, the world's most outstanding G.T. car. The 4.2 litre 'XK' engine is fitted as standard to all 'E' type models and provides outstanding acceleration and flexibility of performance throughout its very wide speed range. Each model features rich upholstery, fitted carpets, extensive safety padding, comprehensive instrumentation and fresh air heating and ventilation. Each model combines outstanding handling with the luxury of saloon car comfort — a special kind of motoring which no other car in the world can offer.

ALTERNATOR gives greatly increased current supply over wide range of engine speeds, ensuring adequate current supply—even with city driving—for the extensive electrical service embodied.

PRE-ENGAGED STARTER facilitates starting under conditions of extreme cold.

SHAPED SEATING designed for maximum comfort, and upholstered in finest quality Vaumol leather over Dunlopillo foam rubber cushions.



JAGUAR

Grace...Space...Pace



S P E C I F I C A T I O N S

ENGINE. 6 cylinder, twin overhead camshaft, 4.2 litre XK Jaguar engine. 92.07 mm. bore, 106 mm. stroke (3.625" by 4.1732"), cubic capacity 4235 c.c. (258.43 cu. in.). Compression ratio 9 : 1 (8 : 1 optional). Power output (9 : 1) 265 b.h.p. at 5400 r.p.m., torque 283 ft./lb. at 4,000 r.p.m. Three S.U. carburettors, Type HD.8 with manual choke control. Forced lubrication by submerged pump system incorporating a full flow filter. Chrome iron cylinder block fitted with dry type cylinder liners. Special 'straight port' cylinder head of high tensile aluminium alloy featuring hemispherical combustion chambers and twin overhead camshafts operating large valves of 70° included angle. Aluminium alloy piston. Steel connecting rods fitted with lead indium big end bearings. 2½ ins. diameter counterweighted crankshaft carried on seven large lead indium bearings. Pressurised cooling system with thermostatically controlled, electrically driven fan.

TRANSMISSION. Manually operated four speed, single helical all synchromesh gearbox. Ratios: Top 3.07, 3rd. 3.90, 2nd. 5.34, 1st. 8.23, Reverse 9.47. Centrally positioned change speed lever. Baulk ring synchromesh on all four forward ratios. Borg & Beck 9½DS diaphragm clutch. Hardy Spicer needle bearing propeller shaft. Hypoid rear axle. Ratio 3.07, Optional ratios 3.31 : 1. 3.54. Differential unit mounted in sub-frame carrying the rear suspension.

SUSPENSION—FRONT. Independent front suspension incorporating transverse wishbones and torsion bars controlled by telescopic hydraulic dampers. Anti-roll bar fitted to lower wishbones.

SUSPENSION—REAR. Fully independent rear suspension incorporating, on each side, a lower transverse tubular link pivoted at the wheel carrier and subframe adjacent to the differential case and above this, a halfshaft universally jointed at each end. These serve to locate the wheel in a transverse plane. Longitudinal location is provided by the rubber mountings locating the sub-assembly in the body structure and by a radius arm between the lower link and a mounting point on the body structure. Twin coil springs, each enclosing a telescopic damper, provide the suspension medium. The whole assembly together with the differential unit is carried in an easily detachable frame which is located in the body structure by rubber mountings.

BRAKES. Disc brakes featuring quick-change pads, are fitted to all four wheels. Front brakes fitted on wheel hubs, rear brakes fitted inboard of half shafts adjacent to differential unit. Suspended vacuum type servo operated by tandem master cylinder. System divided into two entirely independent hydraulic circuits to front and rear brakes. Centrally positioned handbrake operates on rear wheels only. Combined handbrake and brake fluid warning light.

STEERING. Rack and pinion. 16 ins. steering wheel with separate adjustments for height and reach. Number of turns lock to lock 2½. Turning circle 37 ft. diameter.

WHEELS AND TYRES. Wire spoke wheels with centre lock hubs fitted with Dunlop 185 × 15 tyres and tubes.

FUEL SUPPLY. By S.U. electric pump. Tank of 14 Imperial gallon capacity. Petrol filter incorporated into fuel line and located by engine compartment.

ELECTRICAL EQUIPMENT, INSTRUMENTS AND FITTINGS. Lucas alternator generator. 12 volt negative earth system. Large capacity battery giving 57 amp-hours at 10 hour rate with current voltage control. Eight fuse control box, fully labelled, located behind hinged central fascia panel for ease of access. Side lamps. Lucas sealed beam, asymmetric dip, headlamps with hand-operated dipping control on fascia. Separate lever actuating headlamp flashing. Separate stop-tail direction and reflector units mounted in a single assembly. Rear number plate lamps. Flashing direction indicators with self-cancellation and warning light on fascia. Instruments and labelled switches illuminated by internal floodlighting controlled by a two-position dimmer switch. Map reading light. Interior light. Twin-blended note horns. Triple blade two-speed self-parking windscreen wiper unit. Electrically operated windscreen washers. Cigar lighter with luminous socket. Starter motor. Vacuum and centrifugal automatic ignition control. Oil coil ignition. 5 ins. diameter 160 m.p.h. speedometer incorporating total and trip distance recorders. 5 ins. diameter electrically operated revolution counter incorporating an electric clock. Ammeter. Electrically operated water temperature gauge, oil pressure gauge, fuel gauge with low level warning light. Choke warning light. Combined handbrake and brake fluid low level warning light. Wiring harness in quickly detachable front body section connected to main circuits through an eight-pin connector mounted on engine compartment bulkhead.

BODY CONSTRUCTION. Stressed shell steel body of unique patented, monocoque construction. Front sub-frame of square section steel tubing carries engine unit, suspension and forward hinged front section.

BODY—OPEN TWO SEATER. Two door two seater body of extremely low drag characteristics resulting from intensive wind tunnel testing. The folding hood incorporating a large rear window is of finest quality mohair, mounted on a special frame to permit single handed erection or stowing. When stowed the hood assembly is completely concealed by a separate detachable cover. Fibreglass detachable hardtop available as an optional extra.

OPEN AND FIXED HEAD COUPE. Counterbalanced, forward opening front section provides excellent accessibility to all mechanical components. Wraparound windscreen and thin pillars provide superb forward visibility. Door lights completely concealed within doors when fully lowered. Wraparound bumpers with overrides at front and rear. Twin bucket seats, adjustable for reach and rake, upholstered in finest quality Vaumol leather over Dunlopillo foam rubber cushions. Three panel fascia. Facia and screen rail in matt grained finish to eliminate reflection. Comprehensive instrumentation with revolution counter and speedometer positioned in front of driver. Central panel contains separate fuel gauge and ammeter, together with a row of labelled tumbler switches controlling ancillary equipment. Separate housing beneath panel contains a radio and twin speakers (optional extra) together with an ashtray. When no radio is fitted, the speaker grilles are retained and the radio control panel aperture is blanked off with an escutcheon. Panel in front of passenger contains an open-fronted glove compartment and grab handle. Three-spoke, polished alloy, lightweight steering wheel with wood rim and central horn push. Wide angle vertically adjustable rear view mirror incorporating anti-dazzle secondary mirror position. Deep pile carpets over thick felt underlay. Luggage accommodation provided in tail of car. Luggage boot lid controlled from inside the car. Seat belt anchorages are incorporated.

HEATING AND DEMISTING. High output fresh air heating and multi-point windscreen demisting system incorporating a two-speed fan controlled by switch on fascia. Temperature and volume of air to windscreen and car interior regulated by controls mounted on fascia panel. Ducts direct air to each side of compartment.

SPARE WHEEL AND TOOLS. The spare wheel is carried beneath the boot floor in a separate compartment and is readily accessible. The tools, in a special fitted and lined container, are housed in the spare wheel compartment.

JACKING. Centrally located jacking sockets enable the front and rear wheels on either side of the car to be raised simultaneously by means of the manually-operated screw type easy lift jack.

PRINCIPAL DIMENSIONS. Wheelbase, 8 ft. 0 ins. Track, front and rear, 4 ft. 2 ins. Overall length, 14 ft. 7 7/8 ins. Overall width, 5 ft. 5 1/2 ins. Overall height, 4 ft. 0 ins. Ground clearance (laden) 5 1/2 ins. Dry weight 2790 lbs.

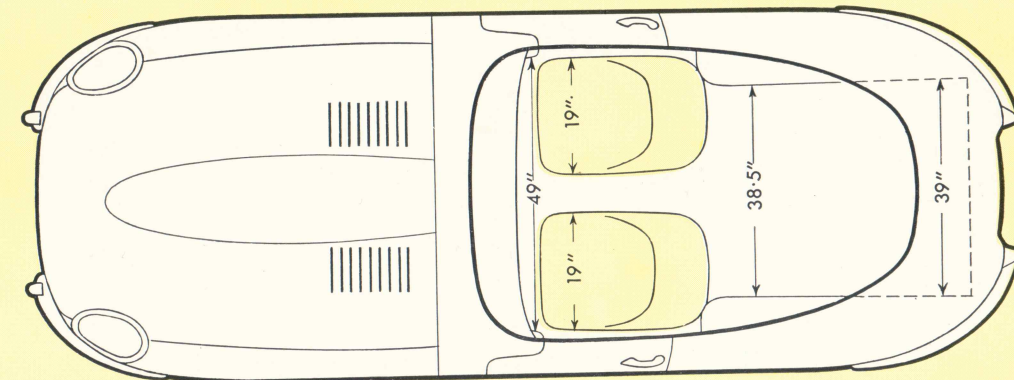
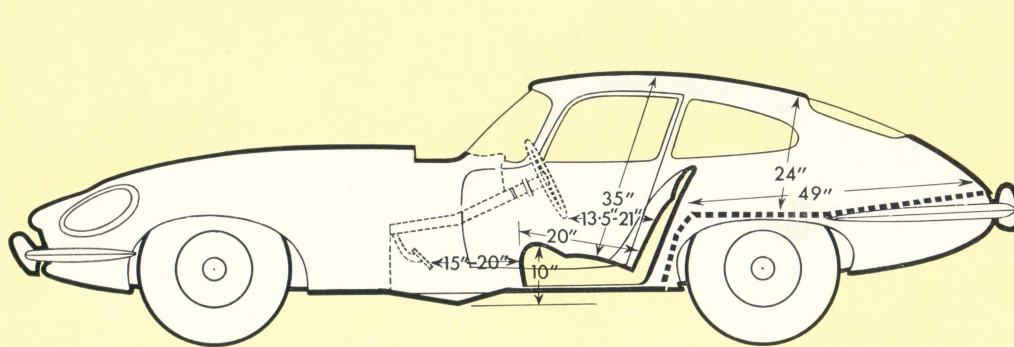

J A G U A R C A R S L T D · C O V E N T R Y · E N G L A N D

The issue of this catalogue does not constitute an offer. The specifications described in this publication vary for different countries and Jaguar Cars Ltd., reserve the right to amend specifications without notice.

Printed in England by W. W. Curtis Ltd., Coventry. 1/68