

X-TYPE
ESTATE



JAGUAR



CONTENTS

4 JAGUAR: A UNIQUE APPEAL 6 PERFORMANCE IN A NEW SHAPE: THE X-TYPE ESTATE RANGE
10 A CAR OF MANY FACETS: X-TYPE ESTATE INTERIORS 16 ENERGY AND INTELLIGENCE: X-TYPE ESTATE TECHNOLOGY
26 TECHNICAL SPECIFICATIONS AND KEY STANDARD EQUIPMENT 28 EXTERIOR COLOURS AND WHEELS
30 INTERIOR CHOICES 32 VEHICLE PERSONALISATION 33 SERVICE, ASSURANCE AND PEACE OF MIND
34 THE JAGUAR OWNERSHIP EXPERIENCE

JAGUAR
A UNIQUE APPEAL

The Jaguar name instils passion and anticipation around the world. It stands for design that is instantly recognised yet continuously evolving. It promises and delivers legendary levels of comfort and sporting, satisfying handling. It brings you the benefit of years of development through motor sport, with instant power that produces a sheer adrenaline thrill.

To own a Jaguar is to experience a unique spirit.
To drive a Jaguar is an ambition fulfilled.

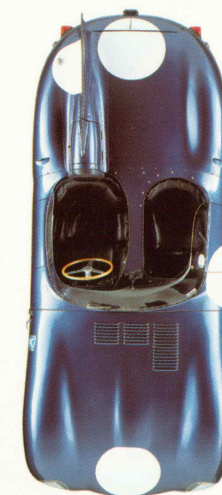

PERFORMANCE IN A NEW SHAPE

THE X-TYPE ESTATE RANGE

From any angle, it's undoubtedly a Jaguar, with a shape that communicates power, luxury and presence. Yet for the first time from Jaguar, this is a performance car that is also an estate.

The X-TYPE Estate opens up a world of possibilities. There are three distinct themes of styling and equipment: X-TYPE Classic, X-TYPE SE and X-TYPE Sport. With a choice of three engines: a 2 litre diesel, 2.5 litre and 3 litre petrol V6, including the Traction[®] four-wheel-drive system on 2.5 litre and 3 litre models. All cars are equipped with a five-speed manual gearbox and for the petrol models, there's the option of a five-speed electronic automatic transmission.

In addition, the X-TYPE Estate brings you more: a combination of versatility and the traditional Jaguar virtues that give every journey an even greater sense of reward and satisfaction.

Car shown: X-TYPE SE Quartz paint. Optional 18" Melbourne alloy wheels.





101 YYY

A CAR OF MANY FACETS

X-TYPE ESTATE INTERIORS

The X-TYPE Estate accommodates the flexibility of modern lifestyles, without sacrificing the traditional Jaguar qualities of painstaking craftsmanship and superior comfort. So you can enjoy an interior with innovative driver control and safety systems technology, whilst appreciating the finely stitched cloth or leather upholstery and rich wood veneers.

The X-TYPE Estate range is fitted with a tailgate window that opens independently for extra convenience and rear seats that are split 70/30 to fold separately. Folding them both down creates a load space that is the largest in its class, without the need to remove the rear headrests. At all times your comfort is assured, with air conditioning, electric height adjustment for the driver's seat and an intrusion sensing security system, all as standard features.

Car shown: X-TYPE SE Quartz paint. Optional 18" Melbourne alloy wheels and rear parking assist.



X-TYPE SE
her upholstery with
space includes four
lights and chromed
compartment doors.







X-TYPE SPORT
The Sport interior showing optional Sport seats
Warm Charcoal Alcantara®.

ENERGY AND INTELLIGENCE

X-TYPE ESTATE TECHNOLOGY

Jaguar has always used technology to put its cars at the forefront of their class. The X-TYPE Estate's modern innovations include Traction[®] four-wheel-drive, standard on 2.5 litre and 3 litre petrol models, or electronic traction control, fitted to 2 litre diesel models. Plus the options of Dynamic Stability Control with Emergency Brake Assist and headlights which turn on automatically when light levels fall.

Effective passive safety including an exceptionally robust body is an integral and reassuring part of the X-TYPE's design. The X-TYPE Estate is also equipped with advanced active safety systems, yet their technology does not diminish the driving experience. Instead it enhances it by ensuring you feel naturally and comfortably in control. So you can appreciate the quality for which Jaguar cars have become legendary: transforming an ordinary road into an exhilarating drive.



ELECTRONIC TRACTION CONTROL

Fitted to the 2 litre diesel X-TYPE Estate, traction control uses the ABS sensors to detect wheel spin and restrict power to either of the front wheels until full adhesion is regained.

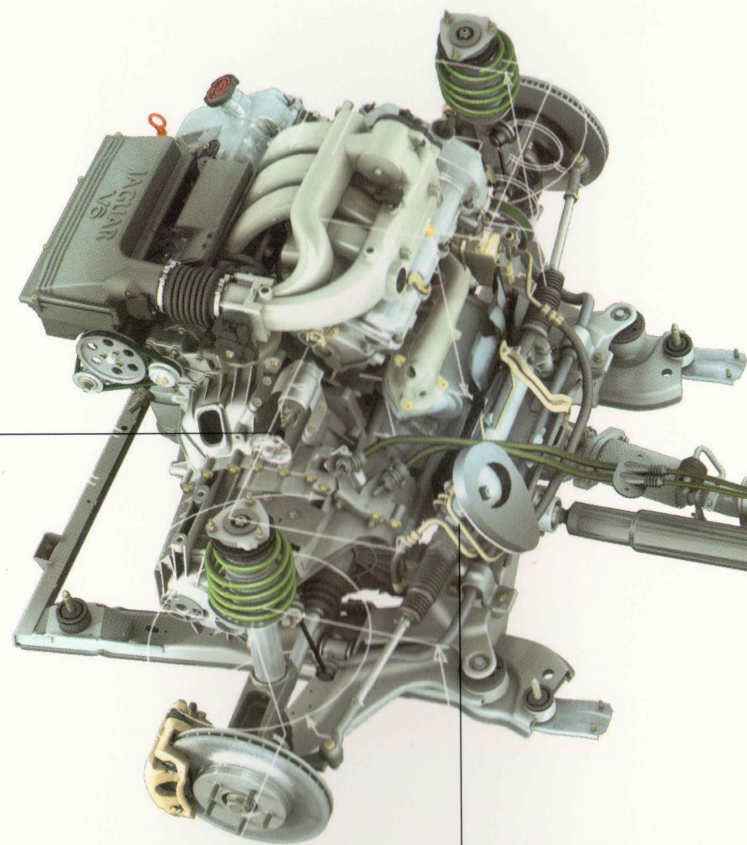

VARIABLE RATIO POWER ASSISTED STEERING

A variable ratio gives you a slower ratio around the straight-ahead position, improving high speed and on-centre stability, balanced with greater agility and fewer turns of the steering wheel from lock to lock when parking.

DSC

Optional Dynamic Stability Control gives you an extra feeling of confidence in your X-TYPE. If it detects that the car is not turning in accordance with your steering input, it reduces engine power and gently applies the brakes so that stability and full control are restored.

EBD

Electronic Brake force Distribution regulates the effort between the front and back brakes, taking the car's load and speed into account, to optimise stopping performance and vehicle stability.

ABS

The four-channel System ensures wheels don't lock up during hard braking on wet, slippery roads to help you retain control and avoid obstacles.

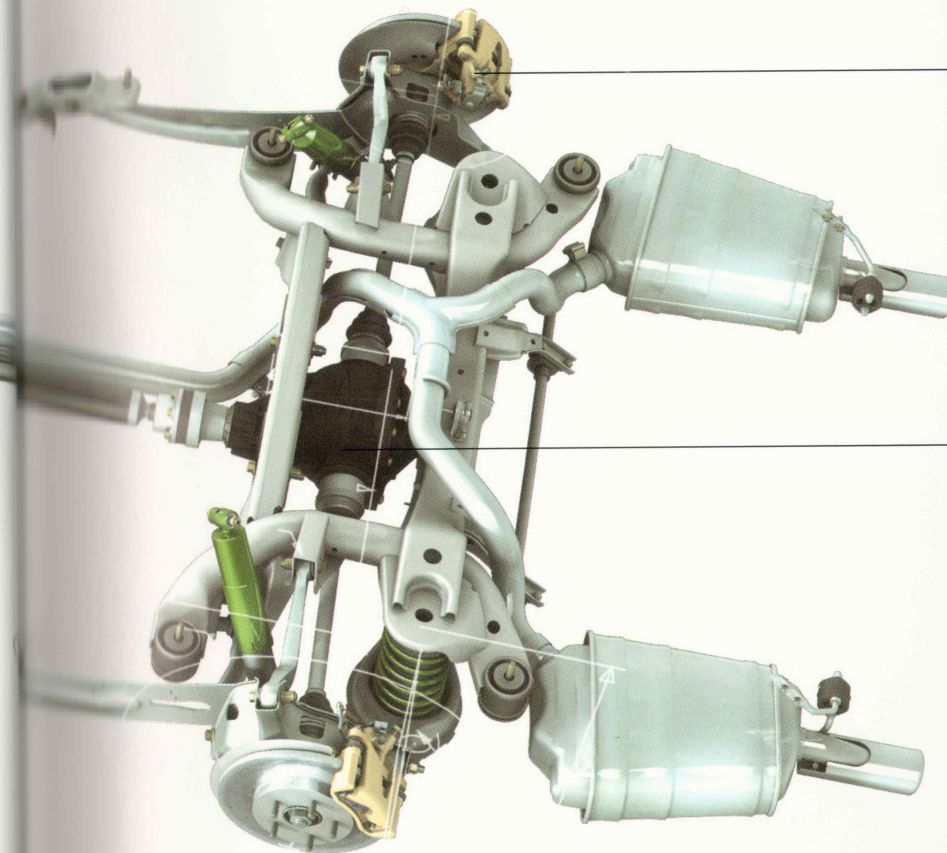

FOUR-WHEEL TRACTION

With 150hp and 3 litre petrol power in a 4-cylinder engine, you get more grip between wheels, it's the optimum traction.

AIRBAGS
Large front
airbags for the
driver and front
passenger. Side
airbags for the
front seats, and
curtain airbags
for the rear seats.
All airbags are
standard and
always used.

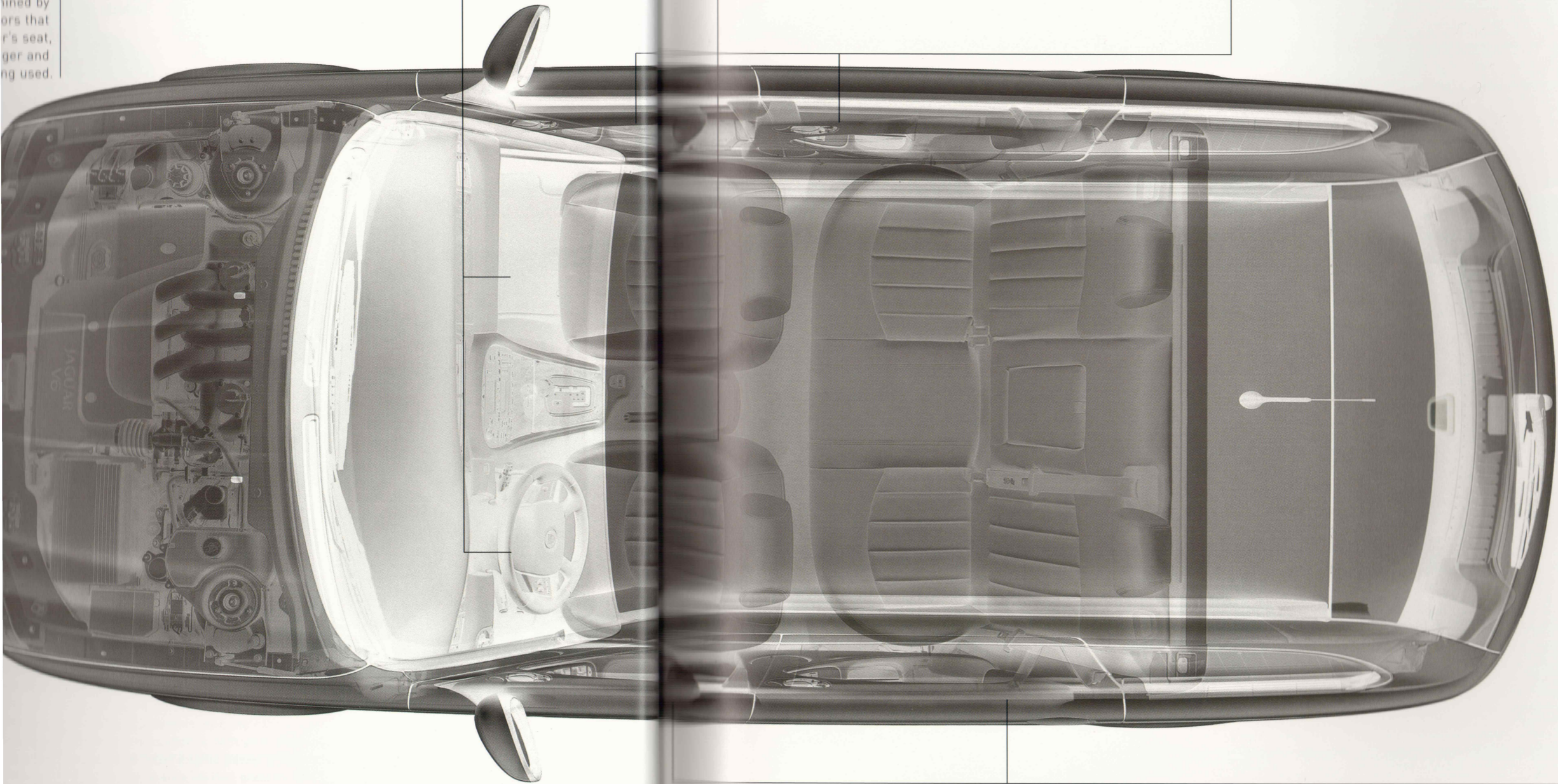

FRONT BELT PRE-TENSIONERS

The X-TYPE Estate's front seatbelts have pre-tensioners that react in milliseconds to hold the occupant safely in position.

SIDE IMPACT PROTECTION

To complement its side and curtain airbags, the X-TYPE Estate has reinforced anti-intrusion bars in all four doors, to resist the force of a collision.



We spend upwards of 175,000 hours of computer processing time assessing safety performance on a new vehicle programme. Multiple analysis runs are conducted from concept through to vehicle sign-off, checking performance through multiple crash scenarios. The analysis enables us to understand in detail and optimise the interaction of the structure, powertrain, chassis, trim and restraint systems. The entire system works as one to offer maximum protection to the occupants.

We still crash cars as final confirmation of safety performance. Even with the significant use of analysis tools we will complete approximately 160 component and system tests and sacrifice around 80 cars to confirm what the computers have predicted.

MARK JOHNSON
Assurance Manager, Vehicle Safety

SIDE AND CURTAIN AIRBAGS

The moment a side impact occurs, side curtain airbags drop down from above the doors to cover the front and side windows, shielding the heads and torsos of front and rear occupants. At the same time, side airbags deploy from the outer side bolsters of the front seats to help protect the driver's or passenger's rib cage.

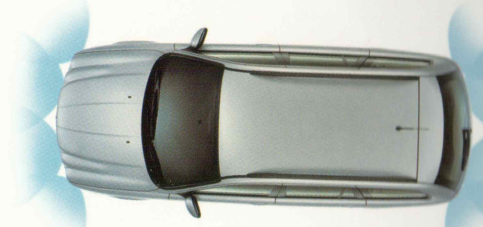

POWER FOLDBACK MIRROR
 Ideal for squeezing through tight
 gaps and to prevent damage to
 optional power foldback mirrors,
 operate at the touch of a button.

PARKING AID
 The optional parking sensors detect any obstacles within their
 range (see graphic), warning you with a series of beeps as you maneuver.
 The closer together the beeps, the nearer the car is to the obstacle.

SATELLITE NAVIGATION AND JAGUARVOICE
 The optional DVD-based satellite navigation system can be controlled by JaguarVoice (also optional).
 Simply press a button on the steering wheel and your spoken commands will also control the main
 functions of the automatic climate control, audio and (where fitted), television and telephone.

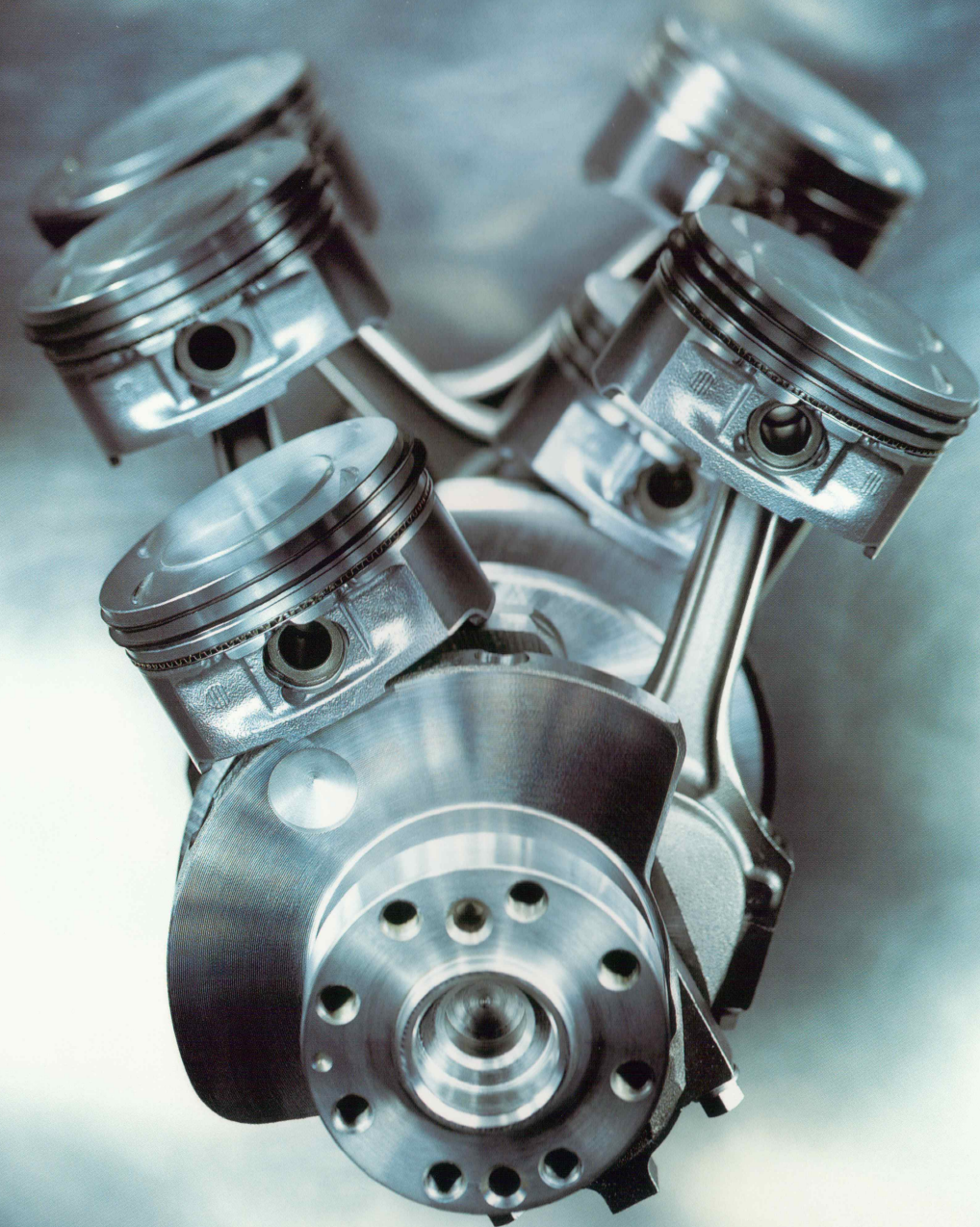

V6 POWER

The heart of any performance car is its engine. The X-TYPE Estate petrol engine is a superb four camshaft, 24 valve V6 with a high torque output at low to medium engine speeds for easier overtaking and relaxed, quiet cruising. The X-TYPE 2 litre diesel engine delivers genuine Jaguar performance, using short nozzle injectors and an innovative transient overboost to produce the highest torque output of any X-TYPE engine.

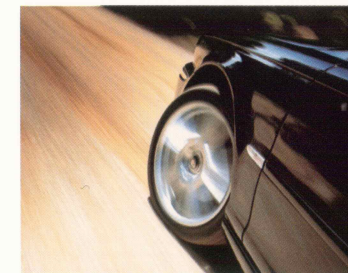

Use of the V6 in the X-TYPE brings particular benefits and not just in terms of its smoothness and performance. The V6 is a short, compact, stiff package, so its lightness contributes to good handling. It also helps us achieve excellent crush performance; because it's compact, it's less likely to compromise the passenger safety cell in a frontal impact: a valuable safety feature.

The new diesel engine produces lots of low rpm torque and that's a vital feature; precisely the performance characteristics you want for usable, real-world acceleration and fast and relaxed cruising. It has real Jaguar DNA, so the X-TYPE Diesel definitely drives like a Jaguar.

TONY CARTWRIGHT
Chief Engineer, Powertrain

TECHNICAL SPECIFICATIONS

ENGINE	2.5 LITRE V6 TRACTION [®] (four-wheel-drive)		3 LITRE V6 TRACTION [®] (four-wheel-drive)		2 LITRE DIESEL
	Cylinders/valves per cylinder	6/4		6/4	
Bore/stroke – mm	81.6/79.5		89.0/79.5		86/86
Capacity – cc	2,495		2,967		1,998
Maximum power – DIN bhp (kW)	194 (145)		231 (172)		128 (96)
EEC PS (kW) @ rev/min	196 (144) @ 6,800 rpm		231 (169) @ 6,800 rpm		130 (96) @ 3,800 rpm
Maximum torque – DIN lb.ft. (Nm)	180 (244)		209 (284)		244 (331)
EEC lb.ft. (Nm) @ rev/min	178 (241) @ 3,000 rpm		206 (279) @ 3,000 rpm		243 (330) @ 1,800 rpm
Compression ratio :1	10.3		10.5		18.2
Transmission	5-speed manual	5-speed automatic	5-speed manual	5-speed automatic	5-speed manual
PERFORMANCE (1)					
Acceleration 0-60 mph (0-100 km/h) – sec	8.2 (8.6)	8.8 (9.2)	6.9 (7.3)	7.3 (7.8)	9.8 (10.2)
Top speed – mph (km/h)	138 (222)	135 (217)	144 (232)	141 (227)	123 (198)
FUEL ECONOMY					
Urban – mpg (l/100km)	20.5 (13.8)	18.6 (15.2)	19.0 (14.9)	18.5 (15.2)	36.7 (7.7)
Extra urban – mpg (l/100km)	38.5 (7.3)	36.9 (7.7)	36.4 (7.8)	35.9 (7.9)	60.4 (4.7)
Combined – mpg (l/100km)	29.0 (9.7)	27.1 (10.4)	27.3 (10.4)	26.6 (10.6)	48.7 (5.8)
Carbon dioxide emissions – g/km	239	249	249	254	154
Tank capacity – gals (Ltr) approx. (incl. 5 Ltr reserve)	13.5 (61.5)	13.5 (61.5)	13.5 (61.5)	13.5 (61.5)	13.5 (61.5)
WEIGHT (2) / DIMENSIONS					
Kerb weight – lb (kg)	3,539 (1,605)	3,605 (1,635)	3,539 (1,605)	3,605 (1,635)	3,473 (1,575)
Gross vehicle weight – lb (kg)	4,586 (2,080)	4,675 (2,120)	4,586 (2,080)	4,675 (2,120)	4,520 (2,050)
Permitted roof load – lb (kg)		165 (75)		165 (75)	165 (75)
Permitted trailer load, unbraked – lb (kg) (3)		1,654 (750)		1,654 (750)	1,654 (750)
Permitted trailer load, braked – lb (kg) (3)		3,307 (1,500)		3,307 (1,500)	3,307 (1,500)
Permitted towbar download – lb (kg)		132 (60)		132 (60)	132 (60)
Turning circle (kerb to kerb) – ft. in. (m)		35' 7" (10.84)		35' 7" (10.84)	35' 7" (10.84)
Luggage capacity: rear seats up, to luggage blind – cu. ft. (litres – VDA)		16 (445)		16 (445)	16 (445)
Luggage capacity: maximum with rear seats forward – cu. ft. (litres – VDA)		50 (1,415)		50 (1,415)	50 (1,415)

(1) The fuel economy figures were obtained in tests carried out in line with the Passenger Car Fuel Consumption Amendment Order 1996 (Reflecting EU Directive 1999/100 EEC fuel consumption test cycle). These figures were correct at the time of going to press.

(2) Please consult your dealer for details of changes associated with option fitment. Kerb weights reflect vehicles to standard specifications. Optional extras increase weight.

(3) Up to maximum 12% gradient.

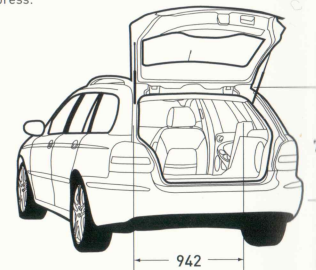
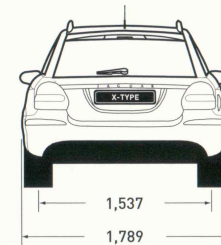
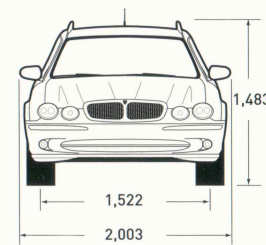
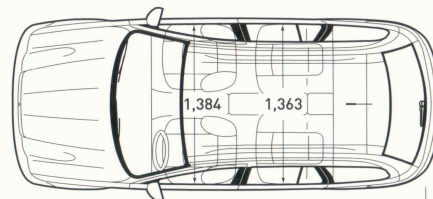
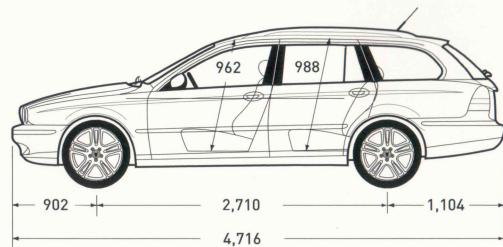

Dimensions shown in mm.

NOTE: The dimension details refer to a nominal car but may vary marginally from car to car due to design and production tolerances. The nominal condition has been used wherever possible. Please consult your dealer for details of changes associated with option fitment.

V6
(front-wheel-drive)

3 LITRE V6
TRACTION® (four-wheel-drive)

2 LITRE DIESEL

	6/4	4/4		
	89.0/79.5	86/86		
	2,967	1,998		
	231 (172)	128 (96)		
rpm	231 (169) @ 6,800 rpm	130 (96) @ 3,800 rpm		
	209 (284)	244 (331)		
rpm	206 (279) @ 3,000 rpm	243 (330) @ 1,800 rpm		
	10.5	18.2		
5-speed automatic	5-speed manual	5-speed automatic	5-speed manual	
	8.8 (9.2)	6.9 (7.3)	7.3 (7.8)	9.8 (10.2)
	135 (217)	144 (232)	141 (227)	123 (198)
	18.6 (15.2)	19.0 (14.9)	18.5 (15.2)	36.7 (7.7)
	36.9 (7.7)	36.4 (7.8)	35.9 (7.9)	60.4 (4.7)
	27.1 (10.4)	27.3 (10.4)	26.6 (10.6)	48.7 (5.8)
	249	249	254	154
	13.5 (61.5)	13.5 (61.5)	13.5 (61.5)	13.5 (61.5)
	3,605 (1,635)	3,539 (1,605)	3,605 (1,635)	3,473 (1,575)
	4,675 (2,120)	4,586 (2,080)	4,675 (2,120)	4,520 (2,050)
		165 (75)		165 (75)
		1,654 (750)		1,654 (750)
		3,307 (1,500)		3,307 (1,500)
		132 (60)		132 (60)
		35' 7" (10.84)		35' 7" (10.84)
		16 (445)		16 (445)
		50 (1,415)		50 (1,415)

reactive 1999/100 EEC fuel consumption test cycle). These figures were correct at the time of going to press. is increase weight.

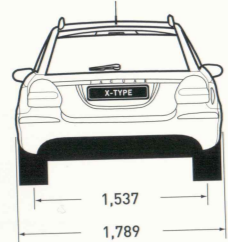
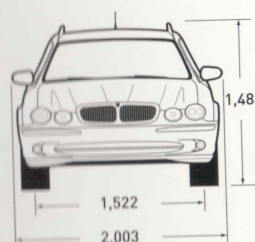

Please consult your dealer for details of changes associated with option fitment.

KEY STANDARD EQUIPMENT

	Classic	SE in addition to Classic	Sport in addition to Classic
TRANSMISSION, SUSPENSION, BRAKES	<ul style="list-style-type: none"> 5-speed manual transmission Jaguar Traction® (full-time, four-wheel-drive) Touring suspension Traction control (front-wheel-drive) 	<ul style="list-style-type: none"> Cruise control 	<ul style="list-style-type: none"> Sport suspension
EXTERIOR FEATURES	<ul style="list-style-type: none"> Black roof rails Body coloured bumper blades and de-chromed window surrounds Exterior mirrors - power adjustable, heated Front fog lights 	<ul style="list-style-type: none"> Chrome finish bumper blades, window surrounds and tipped grille vanes 	<ul style="list-style-type: none"> Body colour grille surround and bootlid finisher Rear spoiler
WHEELS	<ul style="list-style-type: none"> Caicos forged alloy 16" 	<ul style="list-style-type: none"> Cayman forged alloy 17" (2.5 litre/3 litre) Tobago forged alloy 16" (2 litre) 	<ul style="list-style-type: none"> Andros forged alloy 17" (2 litre) Aruba forged alloy 18" (2.5 litre/3 litre)
INTERIOR THEMES AND TRIM	<ul style="list-style-type: none"> Colour keyed upper facia and door top rolls, Bronze stained Sapele veneer facia 	<ul style="list-style-type: none"> Door inserts to match facia Four spoke leather rimmed steering wheel with audio, telephone (where fitted), voice and cruise controls Gearknob - leather 	<ul style="list-style-type: none"> Four spoke perforated leather rimmed sport style steering wheel with audio, telephone (where fitted), voice and cruise controls Gearknob - Sport perforated leather Warm Charcoal upper facia and door top rolls with Grey stained Birds Eye Maple veneer facia
SEATING	<ul style="list-style-type: none"> Cloth upholstery Fold down rear seat (split 70/30) Manually adjustable front seats with power drivers seat height adjust 	<ul style="list-style-type: none"> 8-way driver and 2-way passenger power adjustable front seats Leather upholstery 	<ul style="list-style-type: none"> 4-way driver and 2-way passenger power adjustable front seats Sport cloth/leather upholstery
INTERIOR FEATURES	<ul style="list-style-type: none"> Electric front windows with one-touch open and close and anti-trap Electric rear windows with one-touch open and close and anti-trap (2.5 litre) Front double cupholder Hidden stowage under load floor with 12V power supply Luggage cover Manual air conditioning with pollen filter (2 litre) Rear armrest with 2 cupholders Sunvisors illuminated with vanity mirror, driver and front passenger 	<ul style="list-style-type: none"> Automatic climate control with pollen filter Cargo compartment net Centre armrest-Front, sliding Electric rear windows with one-touch open and close and anti-trap Trip computer with message centre 	<ul style="list-style-type: none"> Automatic climate control with pollen filter (2.5 litre/3 litre) Electric rear windows with one-touch open and close and anti-trap (2.5 litre/3 litre)
AUDIO	<ul style="list-style-type: none"> Chrome speaker surrounds • Jaguar Alpine Sound System with 6 speakers, AM/FM radio/single slot CD featuring EON, RDS, PTY, TA and automatic volume control 		
SAFETY	<ul style="list-style-type: none"> Airbags, front and side, driver and front passenger • Anti-lock Braking System • Curtain airbags front and rear • High-level stop light • Occupancy sensing system 		
SECURITY	<ul style="list-style-type: none"> Remote central double locking with 2 stage unlock and perimeter sensing alarm 		
KEY OPTIONS	<ul style="list-style-type: none"> CD autochanger • Dynamic Stability Control (DSC) with Emergency Brake Assist • Front and rear parking assist • Jaguar Alpine Premium Sound System • JaguarVoice Memory function on drivers seat and exterior door mirrors (with 10-way seats) • Navigation system with DVD mapping and 7" Touch-screen Rain sensing windscreen wipers (part of Auto Clear View pack) • TV with Teletext (whilst stationary) 		

For a full list of standard and optional equipment please refer to the Specification and Price Guide or jaguar.co.uk

EXTERIOR COLOUR GUIDE



WHITE ONYX fitted with 16" Caicos alloy wheels



ZIRCON* fitted with 17" Cayman alloy wheels



PLATINUM* fitted with 17" Andros alloy wheels



ULTRAVIOLET* fitted with 18" Aruba alloy wheels

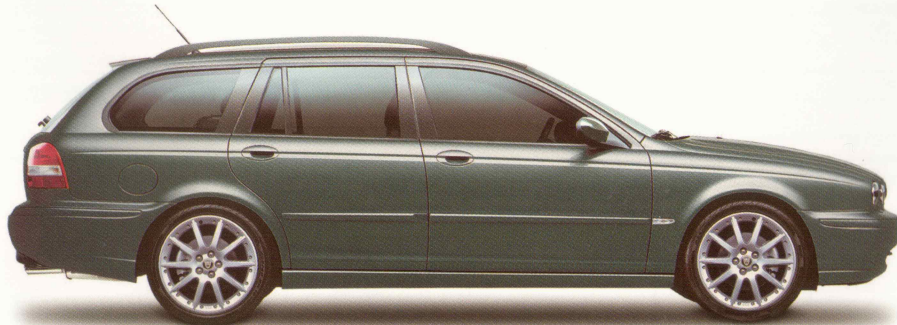

QUARTZ* fitted with 18" Melbourne alloy wheels



PACIFIC* fitted with 16" Tobago alloy wheels

* Metallic paint.

The colours are intended to serve primarily as a guide and, while they approximate to the actual shades, they should not be utilised for paint matching or for any other purpose where complete accuracy is essential. Jaguar Cars Ltd., reserve the right to alter or withdraw any colour finish or trim without notice.



JAGUAR RACING GREEN* fitted with 18" Aruba alloy wheels



BRITISH RACING GREEN fitted with 16" Tobago alloy wheels



EBONY fitted with 17" Cayman alloy wheels



Steel 6.5" x 16" with Saba wheel cover



Caicos 6.5" x 16" alloy



Tobago 6.5" x 16" alloy



Andros 7" x 17" alloy



Cayman 7" x 17" alloy



Aruba 7.5" x 18" alloy



Melbourne R-Performance 7.5" x 18" split rim alloy

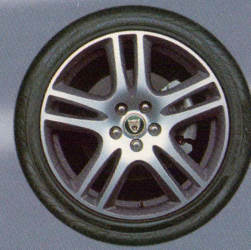

Aruba Performance 7.5" x 18" alloy

★ For wheel availability, please refer to the Specification and Price Guide.



INTERIOR CHOICES



CLOTH [Classic]

WARM CHARCOAL



LEATHER [Classic/SE]

CHAMPAGNE



SPORT CLOTH / LEATHER

CHAMPAGNE



SPORT LEATHER

STONE



LEATHER (Classic/SE)

CHAMPAGNE



SPORT LEATHER

STONE



SPORT LEATHER / ALCANTARA®

WARM CHARCOAL



BRONZE STAINED SAPELE



GREY STAINED BIRDS EYE MAPLE



PIANO BLACK



CARBON FIBRE

TRIM COMBINATIONS

	Champagne	Stone	Warm Charcoal	Bronze stained Sapele	Grey stained Birds Eye Maple	Piano Black	Carbon Fibre
Cloth (Classic)	•		•	•	•	•	
Leather (Classic)	•	•	•	•	•	•	
Leather (SE)	•	•	•	•		•	
Sport Cloth/Leather	•		•	•	•	•	•
Sport Leather	•	•	•	•	•	•	•
Sport Leather/Alcantara®			•	•	•	•	•

SEAT COLOURS

VENEERS

For full details of available colour/trim combinations and extra costs for upholstery materials (where applicable), please consult your dealer and current price list.

THE JAGUAR OWNERSHIP EXPERIENCE

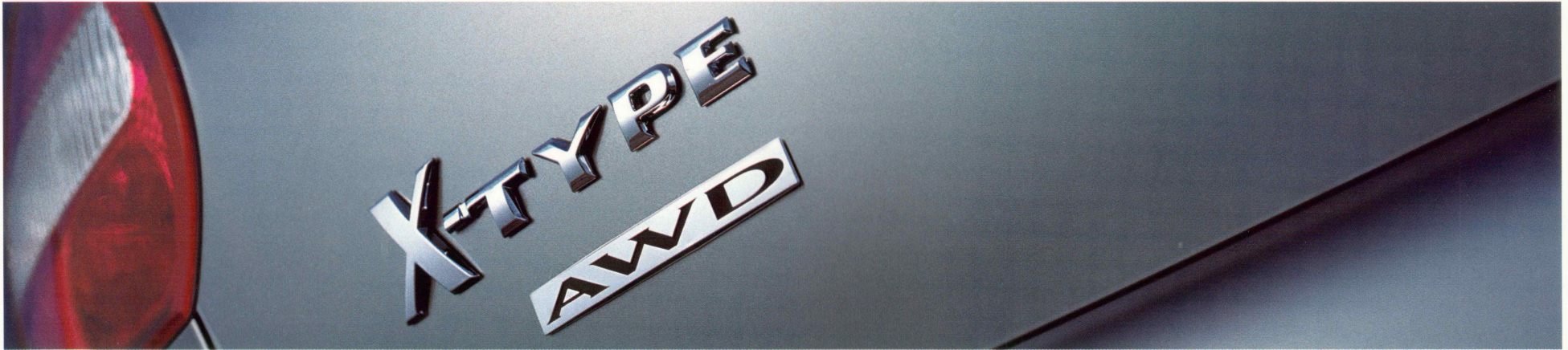

JAGUAR FINANCIAL SERVICES

Jaguar Financial Services offer a range of finance and insurance plans tailored to provide maximum choice and flexibility. You'll be as impressed with the finance as you are with the car. Your Jaguar dealer will match your personal or business requirements to the most appropriate finance plan, provide you with quotations and process your application.

COMPANY CAR OPT OUT

Because of the changes in company car Benefit in Kind taxation introduced in April 2002, many company fleet operators and company car drivers are considering their alternatives. Jaguar Financial Services and Jaguar Cars Limited have jointly developed a combination of Jaguar Privilege PCP, Jaguar Service Contract and Jaguar Insurance finance and insurance plans for business customers and private individuals who may have chosen to opt out of their company car scheme. Please contact your Jaguar dealer for further information.

WWW.JAGUAR.CO.UK

Your personal Jaguar journey may begin with a visit to jaguar.co.uk. The website includes helpful tools such as a dealer locator, specifications and price lists, the latest information on all the Jaguar models, information on clubs, and a fascinating look into the passion and legacy that infuse the Jaguar name.

JAGUAR MAGAZINE

In this unique owners' publication, you can read about exotic and exciting drives to take with your Jaguar, stories of other Jaguar owners and their experiences with their cars, highlights on Jaguar's activity in the exciting world of Formula One racing, and the finer things that go hand in hand with a luxury lifestyle.

OWNERSHIP

Your Jaguar comes with Total Care which incorporates a 3 year unlimited mileage Vehicle Warranty, together with a 3 year unlimited mileage Paint Surface Warranty and a 6 year unlimited mileage Corrosion (Perforation) Warranty.



JAGUAR

Born to perform