

EXPORT



BY APPOINTMENT

# MORRIS

1935



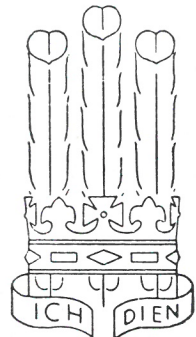

BY APPOINTMENT

AN INTRODUCTION  
TO CARS BUILT BY

# SPECIALISATION

# MORRIS

TRADE MARK

*Sole Exporters:*

**MORRIS INDUSTRIES  
EXPORTS LIMITED**

*Governing Director . . . . . LORD NUFFIELD  
Managing Director . . . . . S. G. K. SMALLBONE*

**COWLEY.. OXFORD.. ENGLAND**

*Cables . . . . . MOREX, OXFORD*

*Manufacturers:*

**MORRIS MOTORS LIMITED**

*Chairman . . . . . LORD NUFFIELD  
Managing Director . . . . . L. P. LORD*

**COWLEY.. OXFORD.. ENGLAND**



*The Home of*

# SPECIAL

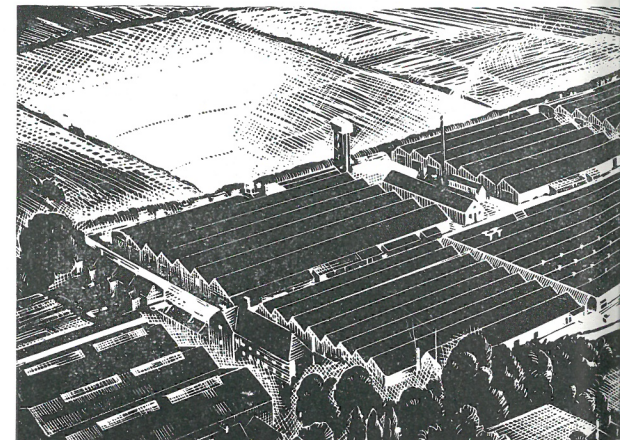
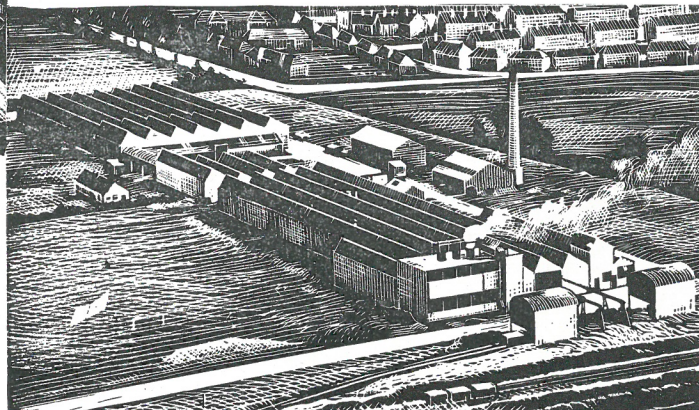
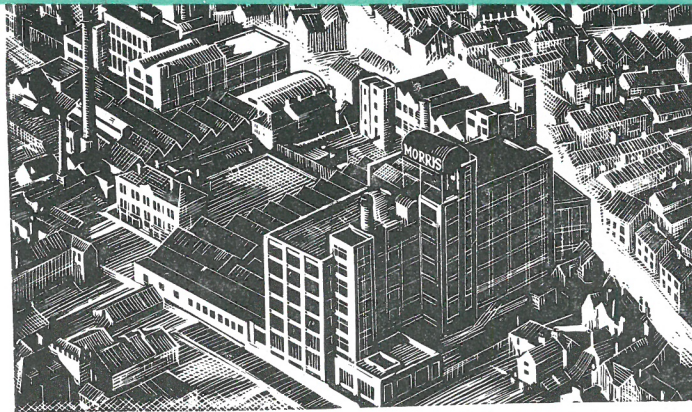

This is how the stage is set for the greatest manufacturing development of recent years—Specialisation. One factory produces nothing but engines . . . another concerns itself solely with foundry work . . . a third concentrates

Only Morris has these facilities

# ISATATION

on radiators . . . a fourth is devoted entirely to coachwork. And the products of these four specialised factories are assembled at Cowley, in the largest and best-equipped motorcar assembly plant in Britain.

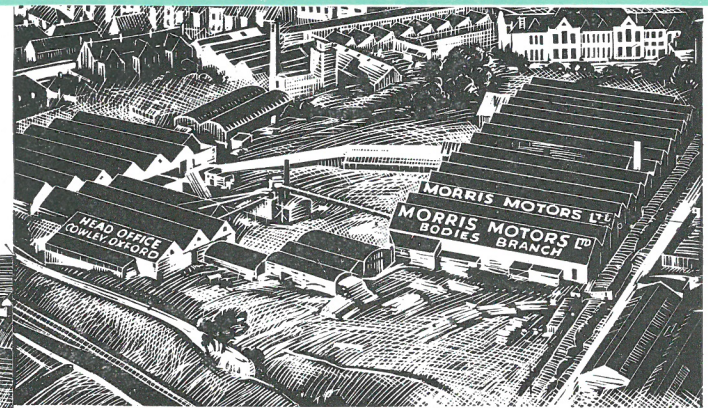
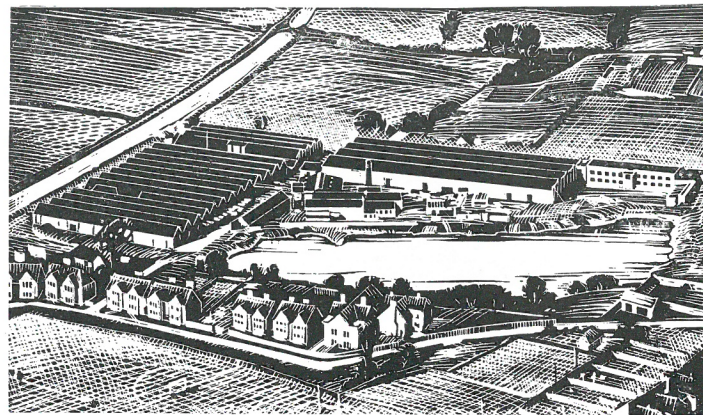
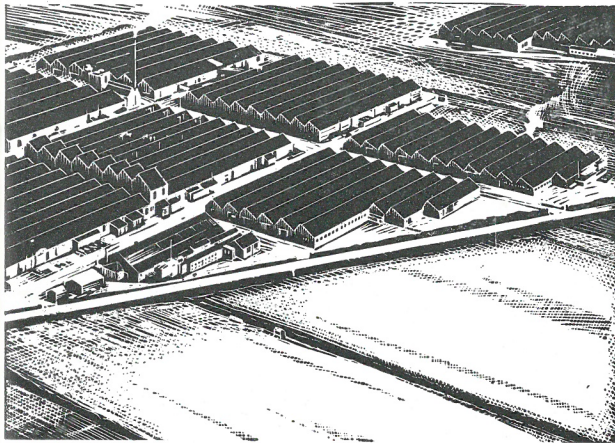

for Specialised Production..

**T**HE best cars have always been produced by Specialisation, but at a prohibitive cost. Now Morris brings you the same precision manufacture at a reasonable price.

*Truffield*

# What 'Specialisation' means to you ...



## LORD NUFFIELD EXPLAINS HIS POLICY OF SPECIALISED PRODUCTION

When I first conceived the idea of Specialisation in connection with Morris cars I was told that it was a wonderful ideal, but a practical impossibility unless I doubled the price of every model. The sceptics were, however, reckoning without the vast resources that lie behind Morris cars.

Specialisation on a small scale would undoubtedly mean a tremendous increase in overhead expenses. But helped by the enormous Morris sales ; by the sustained, calculable demand ; by an organisation and facilities unrivalled in the British motor industry, we have been able to achieve something that would be an impossibility for other manufacturers.

In the course of industrial progress, mass-production has played an invaluable part. But to-day the public rightly expect *precision workmanship*.

We of Morris can proudly claim to be the first to offer precision-made cars at reasonable prices. We have spent a great deal of money putting Specialisation gradually into practice during the last twelve months ; but already results have proved the expenditure amply justified. The servicing costs on last year's Morris cars have been the lowest on record—even lower than I myself had dared to hope. And in placing before you the 1935 Morris range, I confidently predict that these cars will mark the beginning of a new, more reliable, more satisfying era in the history of motoring.

**I**T has been left to Morris . . . a British firm British owned using British labour and material, to give the lead to the rest of the world . . . We have gone another step ahead in introducing Specialisation.

# Specialisation *alone makes possible* *these New Morris Models...*

## THE NEW MORRIS EIGHT

TWO-SEATER	...	...	...	...	...
TOURER	...	...	...	...	...
TWO-DOOR SALOON (Fixed Head)	...				...
TWO-DOOR SALOON (Sliding Head)	...				...
FOUR-DOOR SALOON (Fixed Head)	...				...
FOUR-DOOR SALOON (Sliding Head)	...				...

## THE MORRIS TEN FOUR

TWO-SEATER	...	...	...	...	...
TOURER	...	...	...	...	...
SALOON (Fixed Head)	...	...	...	...	...
SALOON (Sliding Head)	...	...	...	...	...
SPECIAL COUPÉ (Sliding Head)	...	...	...	...	...

## THE MORRIS TEN SIX

TWO-SEATER	...	...	...	...	...
TOURER	...	...	...	...	...

SALOON (Fixed Head)	...	...	...
SALOON (Sliding Head)	...	...	...
SPECIAL COUPÉ (Sliding Head)	...	...	...

## THE MORRIS TWELVE FOUR

SALOON (Fixed Head)	...	...	...
SALOON (Sliding Head)	...	...	...

## THE MORRIS FIFTEEN SIX

SALOON (Fixed Head)	...	...	...
SALOON (Sliding Head)	...	...	...
SPECIAL COUPÉ (Sliding Head)	...	...	...

## THE MORRIS OXFORD TWENTY

SALOON (Sliding Head)	...	...	...
SPECIAL COUPÉ (Sliding Head)	...	...	...



**B**EWARE of Gadgets and so-called Mechanical Improvements . . . Morris have first choice of all important new inventions, but only after very careful testing do we incorporate anything on our cars. The last few years have seen many new-fashioned selling features that are liable to prove worthless in a few years' time. Morris are continually spending large sums of money in developing and experimenting, and no invention is overlooked which could benefit customers or improve our products.

# a word on the Special Morris Features ....

Here are a few examples of Morris *modernity*. From stem to stern, every Morris car is up-to-the-minute in design. No worth-while detail is omitted from Morris specifications. The best safety features . . . the best easy-driving features . . . the best comfort features . . . Morris has them all !

**Reinforced Coachbuilt Bodies.** All Morris bodies are coachbuilt and reinforced with steel facings, thus combining the best features of the coachbuilder's craft and steel bodywork technique, retaining the advantages of both without their individual disadvantages.

**Durable Fabrics.** All materials used in the production of Morris cars are tested for quality in special ageing machines to ensure their complete suitability.

**Rubber-backed Carpets.** All carpets on Morris cars have a rubber layer between the pile and the backing in which each individual fibre is thoroughly embedded. This positively prevents draughts, fraying, and ensures maximum wearing qualities.

**Rollsvisor.** All Morris closed models except the Eight are fitted with easily controlled anti-glare visors of the roller blind type, which can instantly be adjusted to suit the requirements of the driver.

**Rear Blinds with Remote Control.** All Morris closed models are fitted with concealed rear blinds with remote control actuated by the driver.

**Electric Windscreen Wipers.** All Morris cars are equipped with electric windscreen wipers.

**Adjustable Windscreens.** All Morris closed models are fitted with windscreens opening from the bottom and provided with infinitely variable adjustment.

**Cellulose Finish.** Only cellulose lacquers of the highest quality are used on Morris cars, and unusual care is employed in their selection and application. The coachwork on Morris cars therefore possesses exceptionally high finish and unquestioned durability.

**Sliding Heads.** All Morris closed models can be obtained with sliding heads of the easily operated and thoroughly proved Pytchley type.

**Chromium Finish.** All internal and external bright parts on Morris cars are treated with chromium finish to our own specification, ensuring long life and the minimum of labour in cleaning.

**Controlled Semi-elliptic Springs.** All Morris cars are fitted with long semi-elliptic springs front and rear, controlled by hydraulic shock absorbers with improved cold weather automatic control.

**Sturdy Frames.** All Morris cars, with the exception of the Eight, which has a special form of box frame, are provided with particularly deep frames having sturdy cross members of "X" formation.

**Safety.** Good brakes are an essential for road safety. All Morris cars are equipped with fully compensated Lockheed hydraulic brakes, which not only provide the maximum possible retarding effect, but the lightest actuation, smallest service attention, and longest effective life.

**Driving Ease.** All Morris cars are fitted with Bishop cam steering, giving delightful steering lightness associated with absolute accuracy of control.

**Easy Gear Changing.** All Morris cars are fitted with gearboxes having synchromesh mechanism to ensure easy and quiet gear changes. The larger models are provided in addition with a controllable free wheel which further simplifies gear changing.

**Automatic Ignition Control.** All Morris models are fitted with automatic advance and retard control ; that on the Morris Eight and Morris Oxford Twenty is fully automatic, on the remaining models it is semi-automatic.

**Right-hand Accelerator Pedals.** All 1935 Morris cars, with the exception of left-hand drive models, are fitted with right-hand accelerator pedals.

**Direction Indicators.** All 1935 Morris cars are fitted with concealed traffic indicators, with the exception of some of the open models which have them fitted to the windscreen pillar. On the Morris Oxford the Trafficators are provided with an automatic cancelling switch.

**Safety Battery Master Switch.** All Morris models, with the exception of the Morris Eight, are provided with a safety battery master switch which provides an effective method of dealing with electrical fires.

**Cushion Drives.** All Morris cars are fitted with single-plate clutches having a cushioned hub on the driven plate, thus ensuring perfectly smooth clutch action at all times.

**Smoothness.** Exceptional care is taken in balancing all the components on Morris engines ; this, coupled with their sturdy construction, ensures very smooth running at all speeds with a notable absence of vibration periods.

**Power.** Advanced design and improved manufacturing methods ensure that all Morris engines develop the highest possible sustained output.

**No Fumes.** All Morris engines, with the exception of the Eight, are fitted with fume consuming air cleaner heads which burn up all the objectionable fumes usually discharged into the body.

**Finger-tip Controls.** On all the Morris models the more frequently used controls are conveniently placed on the steering column or steering wheel, where they are readily to hand when required.

**Real Leather Upholstery.** With the exception of the very cheapest models, all Morris cars have the finest leather upholstery —no split hides are used.

**Compensated Voltage Control.** All Morris models from the Twelve Four upwards are fitted with compensated voltage control, which automatically regulates the dynamo output to suit the exact requirements of the electrical equipment.

**Stabilising Bumpers.** All Morris cars from the Ten Six upwards are fitted with front bumpers of the stabilising type which damp out all periodic vibrations arising from road unevenness.

**Draughtless Ventilating Windows.** The larger saloon models, from the Twelve Four upwards, are fitted with anti-draught ventilating windows to the front doors.

**Single-pedal Control with Automatic Clutch Actuation.** The Morris Oxford is fitted as standard with Bendix Automatic Clutch Control, which enables this car to be driven entirely by simple actuation of the accelerator pedal, and which, in conjunction with the free wheel, renders gear changing a ridiculously simple operation.

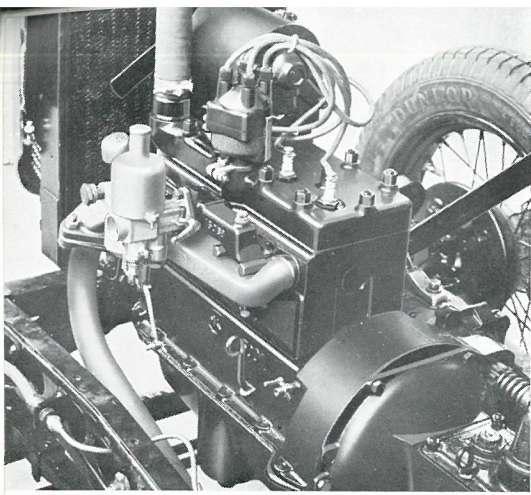

# An entirely new 'EIGHT'

## THE NEW MORRIS EIGHT

Here is one of the most striking products of Morris Specialisation—an entirely new model in which the influence of the specialist is splendidly evidenced. Never has so much sturdy power been found in so diminutive an engine. Never has so much comfortable roominess been available on a car of this rating. Here is a small car built in the best big-car traditions. It is light—inexpensive—economical—but *a real motorcar*! You will soon see the difference when you run a careful eye over the details. Instead of the transverse front springing so often found on “baby” cars, the Morris Eight has semi-elliptic front springs. Instead of mechanised brakes, the Morris Eight has fully compensated Lockheed hydraulics. Instead of a diminutive dynamo it has one 4½ in. in diameter which is fully up to its job. And so it is with every other detail. This new Morris Eight gives you big-car stability—big-car safety—big-car performance—big-car equipment—and very nearly big-car comfort. A worthy addition to the Morris range!

**GENERAL EQUIPMENT.** Concealed direction indicators; Lockheed hydraulic brakes; pile carpets; gearbox draught excluder; speedometer; oil gauge; S.U. electric pressure petrol pump; dash-reading electric petrol gauge; electric windscreen wiper; pressure chassis lubricating pump; electric horn; electric lighting and starting; headlamps with dimming mechanism; sidelamps; hydraulic shock absorbers; door pockets; five detachable Magna type wire wheels; five Dunlop extra low-pressure cord tyres; spare wheel carrier; tyre pump; kit of tools.

### THE MORRIS EIGHT 4-DOOR SALOON (Fixed Head)

**Coachwork.** Black cellulose with red Karhyde upholstery; Red/Black cellulose with red Karhyde upholstery.

**Interior Woodwork.** Polished mahogany.

**Additional Equipment.** Single-panel adjustable windscreen with

toughened Triplex glass, winding door-windows, interior driving mirror, Trafficator mirrors, concealed rear blind with remote control, private locks to doors, bucket type front seat, sliding driver's seat, adjustable tip-up passenger's seat.

### THE MORRIS EIGHT 4-DOOR SALOON (Sliding Head)

**Coachwork.** Blue/Black cellulose with blue leather upholstery; Green/Black cellulose with green leather upholstery; Red/Black cellulose with red leather upholstery.

**Interior Woodwork.** Polished mahogany.

**Additional Equipment.** Pytchley sliding head, single-panel adjustable windscreen and winding door-windows with Triplex toughened glass, interior driving mirror, Trafficator mirrors, concealed rear blind with remote control, private locks to doors, bucket type front seat, sliding driver's seat, adjustable tip-up passenger's seat, bumpers and luggage grid.

TWO - SEATER .. ..

TOURER .. ..

TWO-DOOR  
SALOON .. ..  
(Fixed Head)

TWO - DOOR  
SALOON .. ..  
(Sliding Head)

FOUR - DOOR  
SALOON .. ..  
(Fixed Head)

FOUR - DOOR  
SALOON .. ..  
(Sliding Head)

by **MORRIS** ... *unequaled performance*  
*with exceptional body-space....*

---

**THE MORRIS EIGHT 4-DOOR SALOON (Sliding Head)**

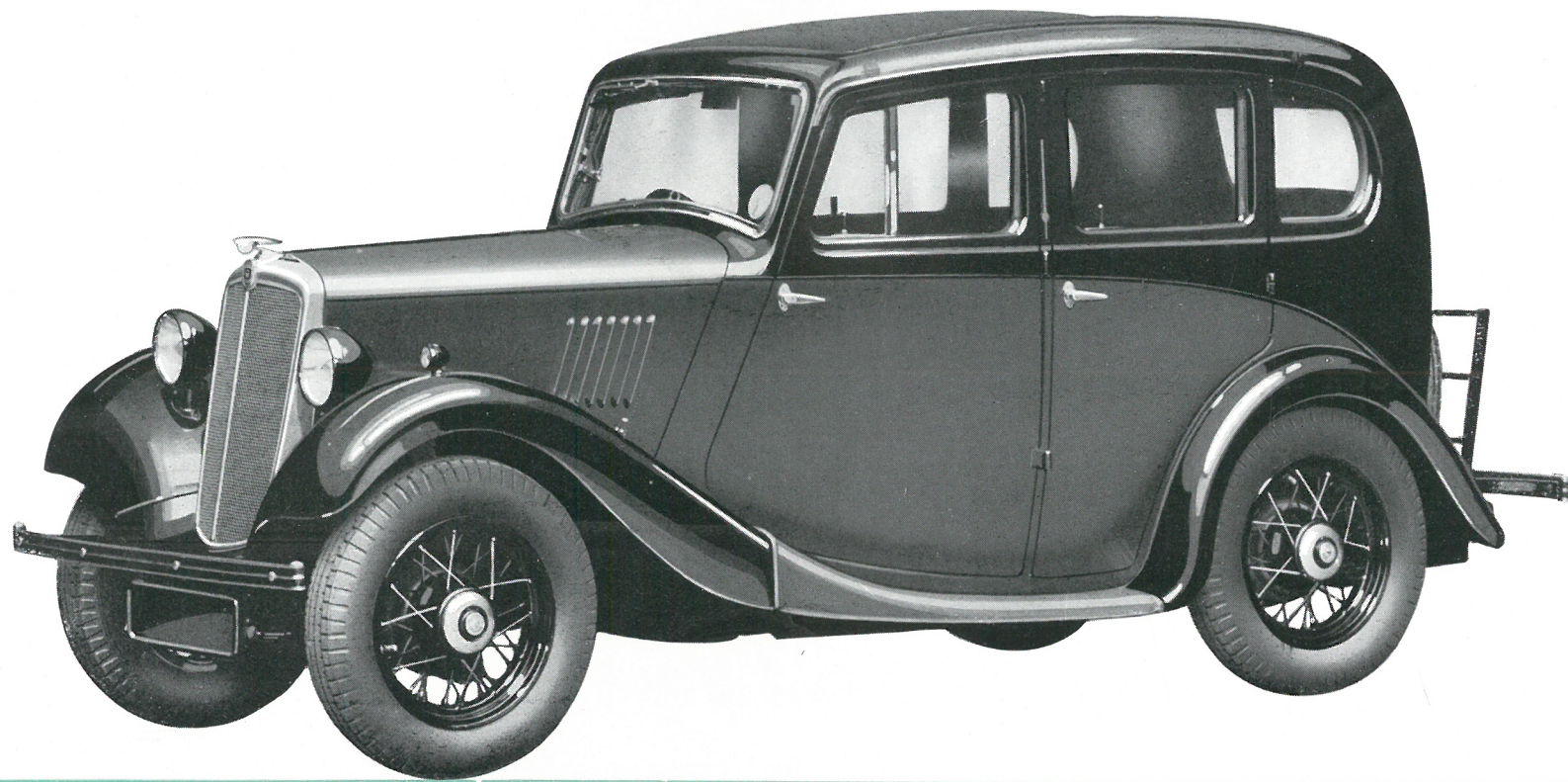

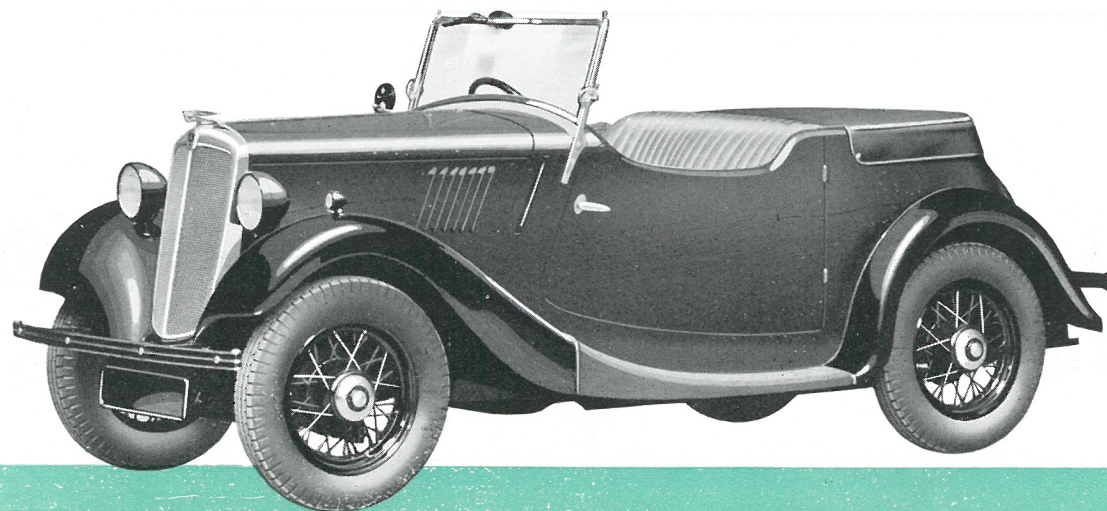

## THE MORRIS EIGHT TWO-SEATER

**Coachwork.** Green cellulose with green Karhyde upholstery ; Black cellulose with green Karhyde upholstery ; Red cellulose with red Karhyde upholstery.

**Additional Equipment.** Folding toughened Triplex glass windscreen, hood, hood bag, detachable sidescreens, exterior driving mirror, adjustable seat.

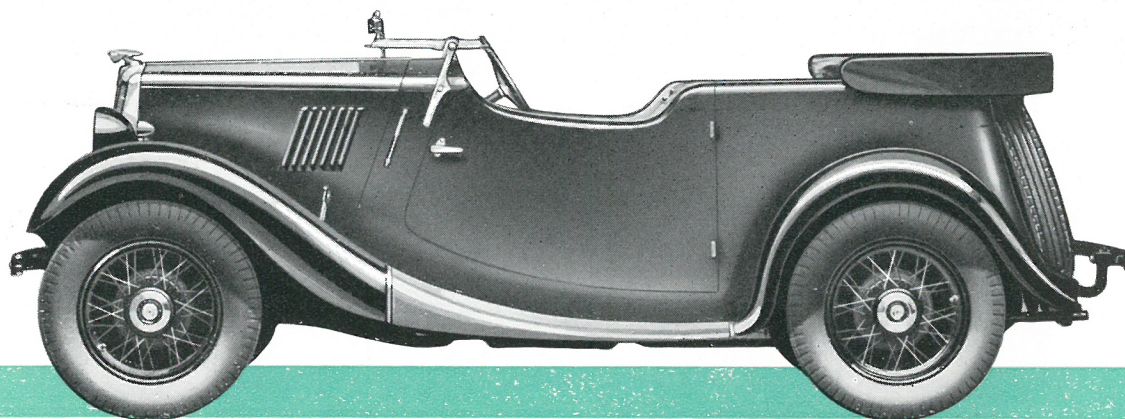

## THE MORRIS EIGHT TOURER

**Coachwork.** Green cellulose with green Karhyde upholstery ; Black cellulose with green Karhyde upholstery ; Red cellulose with red Karhyde upholstery.

**Additional Equipment.** Folding toughened Triplex glass windscreen, hood, hood bag, detachable sidescreens, exterior driving mirror, adjustable hinged bucket seats, pneumatic rear seat.

## THE MORRIS EIGHT 2-DOOR SALOON (*Sliding Head*)

**Coachwork.** Blue/Black cellulose with blue leather upholstery ; Green/Black cellulose with green leather ; Red/Black cellulose with red leather.

**Interior Woodwork.** Polished mahogany.

**Additional Equipment.** Pytchley sliding head, single-panel adjustable windscreen and winding door- and quarter-windows with toughened Triplex glass. Interior driving mirror ; Trafficator mirrors, concealed rear blind with remote control ; bucket type front seats, sliding driver's seat, passenger's seat tip-up adjustable, private locks to doors, bumpers and luggage grid.

## THE MORRIS EIGHT 2-DOOR SALOON (*Fixed Head*)

**Coachwork.** Black cellulose with red Karhyde upholstery ; Red/Black cellulose with red Karhyde upholstery.

**Interior Woodwork.** Polished mahogany.

**Additional Equipment.** Single-panel adjustable windscreen with toughened Triplex glass, winding door- and quarter-windows, interior driving mirror, Trafficator mirrors, concealed rear blind with remote control, bucket type front seats, sliding driver's seat, passenger's seat tip-up adjustable, private locks to doors.

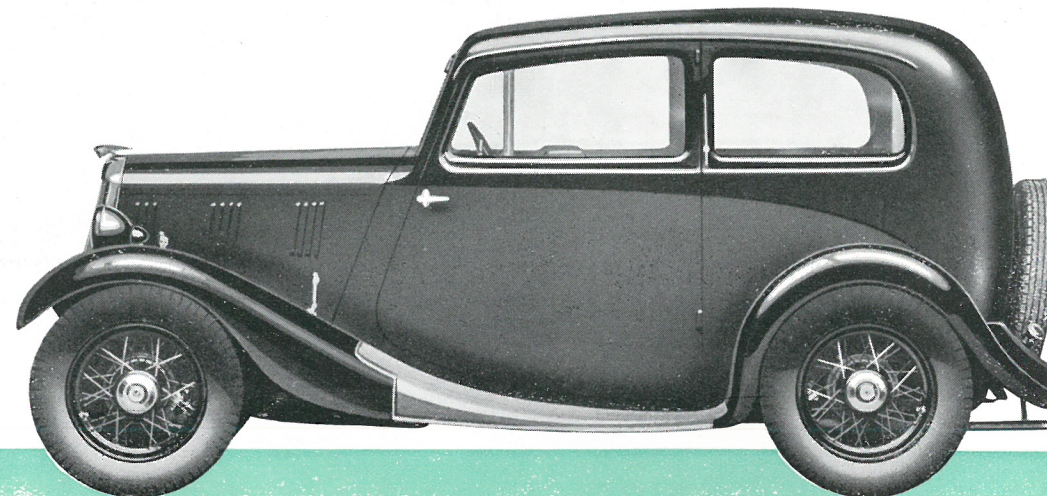

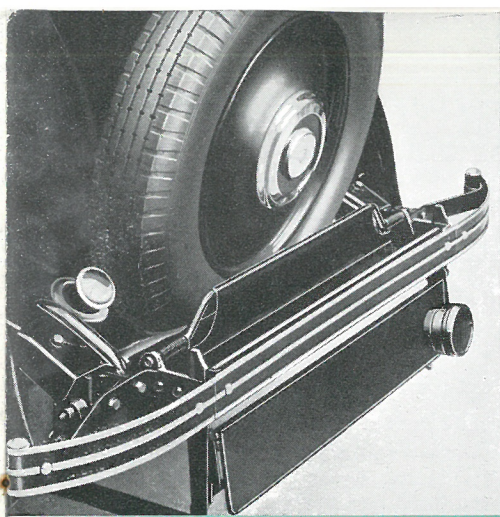

# *The Ten-four .... even finer cars than the enormously popular 1934 models....*

- TWO - SEATER .. ..
- TOURER .. ..
- SALOON .. ..  
(Fixed Head)
- SALOON .. ..  
(Sliding Head)
- SPECIAL COUPÉ .. ..  
(Sliding Head)

It was not without good reason that the sales of the Morris Ten Four were greater last year than those of any other Ten Four on the market. For the Morris Ten represents the ideal "happy medium" between the small car and the large. It offers full saloon comfort in its most economical form. The word economy used in connection with this car is more than a vague, airy claim—as thousands of Morris Ten owners have been able to prove for themselves. The engine has been carefully designed for economical running at attractive road speeds. Steering and suspension have been planned to minimise fatigue and tyre wear. For the man who wants a good-looking, full-sized, amply-powered car, but whose motoring expenditure must be limited, a Morris Ten is unquestionably the car to give him the most pleasure for his money. And whether his tastes incline to the closed or open type of car, there is a specialist-produced Morris Ten to fit in exactly with his ideas.

**GENERAL EQUIPMENT.** Toughened Triplex glass throughout; finger-tip controls for ignition, lamps and horn; direction indicators; Lockheed hydraulic brakes; pile carpets; pedal rubbers; gearbox draught excluders; pedal draught excluders; speedometer; oil gauge; S.U. electric pressure petrol pump; dash-reading electric petrol gauge; electric windscreen wiper; pressure chassis lubricating pump; calorimeter and wings; high-frequency electric horn; electric lighting and starting; stop and tail-light; headlamps with dip and switch mechanism; sidelamps; battery master switch; scuttle side ventilators; hydraulic shock absorbers; door pockets; five detachable disc type wheels; five Dunlop extra low-pressure cord tyres; spare wheel carrier; jack; tyre pump; kit of tools.

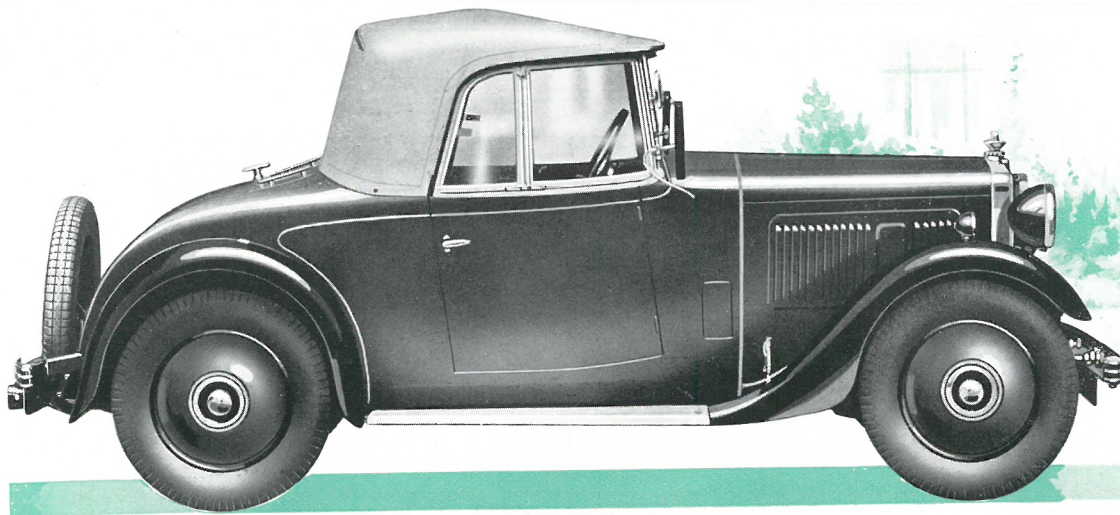

## THE MORRIS TEN FOUR TWO-SEATER

**Coachwork.** Green cellulose with green leather upholstery ; Black cellulose with green leather upholstery ; Red cellulose with red leather upholstery. (Karhyde on dickey seat.)

**Interior Woodwork.** Polished mahogany.

**Additional Equipment.** Hood, hood bag, bumpers front and rear, double-panel adjustable windscreen, detachable side-screens, adjustable single-piece seat, external driving mirror.

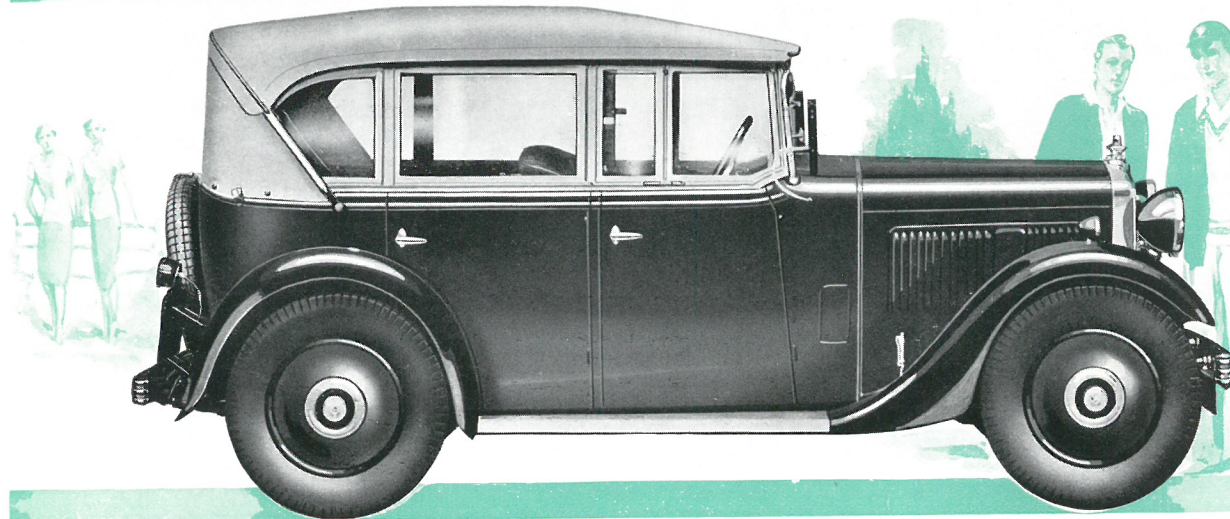

## THE MORRIS TEN FOUR TOURER

**Coachwork.** Green cellulose with green leather upholstery ; Black cellulose with green leather upholstery ; Red cellulose with red leather upholstery.

**Interior Woodwork.** Polished mahogany.

**Additional Equipment.** Hood, hood bag, bumpers front and rear, double-panel adjustable windscreen, detachable side-screens, external driving mirror, single-piece adjustable front seat, luggage grid.

## THE MORRIS TEN FOUR SALOON (Fixed Head)

**Coachwork.** Blue cellulose with blue leather upholstery ; Green/Black cellulose with green leather upholstery ; Black cellulose with green leather upholstery ; Red/Black cellulose with red leather upholstery.

**Interior Woodwork.** Polished mahogany, metal fascia board.

**Additional Equipment.** Single-panel adjustable windscreen, winding door-windows, interior driving mirror, Trafficator mirrors, concealed rear blind with remote control, private locks to doors, bucket type adjustable front seats, roof-lamp, driver's sun blind, parcel net.

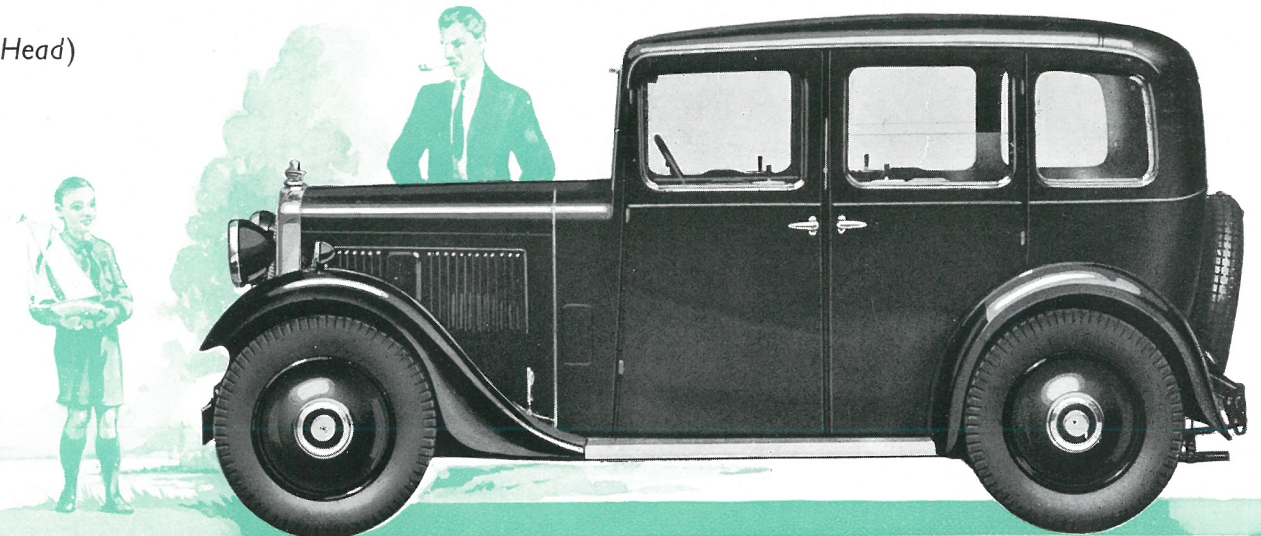

## THE MORRIS TEN FOUR SALOON (*Sliding Head*)

**Coachwork.** Blue cellulose with blue leather upholstery ; Green/Black cellulose with green leather upholstery ; Black cellulose with green leather upholstery ; Red/Black cellulose with red leather upholstery.

**Interior Woodwork.** Polished mahogany, metal fascia board.

**Additional Equipment.** Pytchley sliding head, bumpers front and rear, single-panel adjustable windscreen, winding door-windows, interior driving mirror, Trafficator mirrors, concealed rear blind with remote control, private locks to doors, bucket type adjustable front seats, luggage grid, roof-lamp, driver's sun blind.

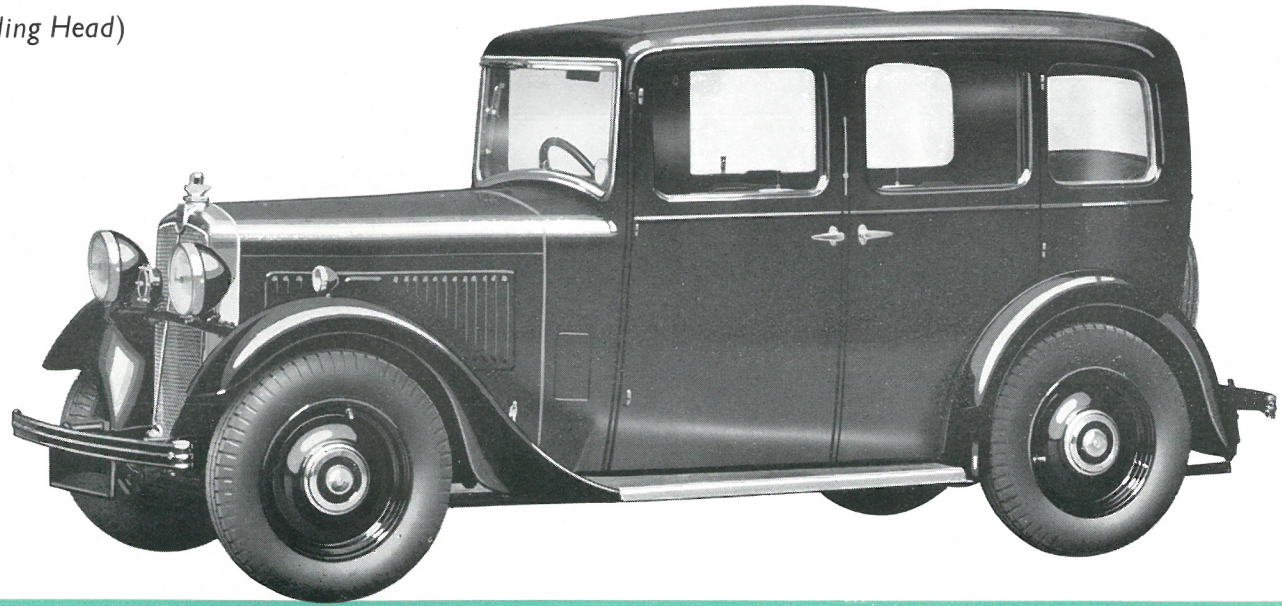

## THE MORRIS TEN FOUR SPECIAL COUPÉ (*Sliding Head*)

**Coachwork.** Green duotone cellulose with green leather upholstery ; Brown duotone cellulose with brown leather upholstery ; Cream/Green cellulose with green leather upholstery ; All Black cellulose with brown leather upholstery.

**Interior Woodwork.** Figured walnut, semi-matt finish.

**Additional Equipment.** Pytchley sliding head, bumpers front and rear, single-panel adjustable windscreen, winding door-windows, interior driving mirror, Trafficator mirrors, rear blind with remote control, art silk pillar pull cords, private locks on doors, bucket type adjustable front seats, pneumatic cushion to rear seat, inbuilt luggage container, roof-lamp, driver's sun blind.

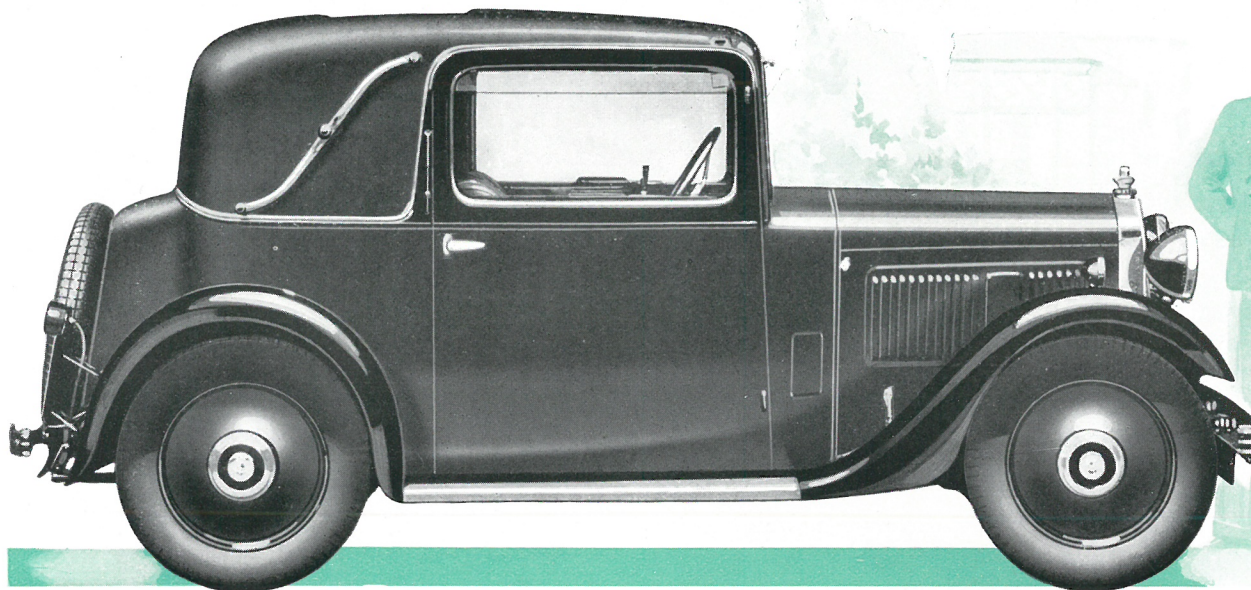



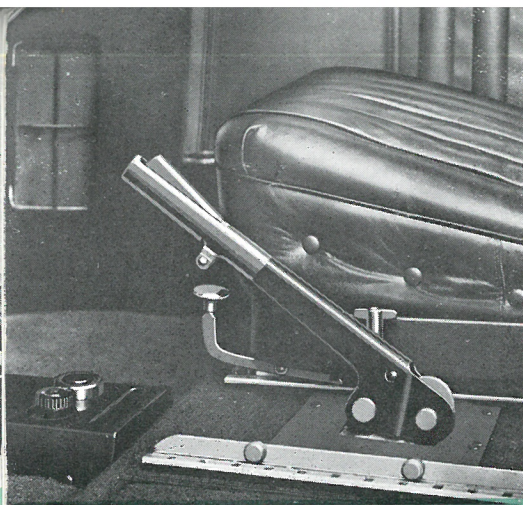

# Morris Ten-six ... *the most attractive small six on the road...*

TWO - SEATER ..

TOURER .. ..

SALOON .. ..  
(Fixed Head)

SALOON .. ..  
(Sliding Head)

SPECIAL COUPÉ ..  
(Sliding Head)

The introduction of the Morris Ten Six brought the smoothness and sweetness of six-cylinder motoring within the reach of all. For this Morris is not only inexpensive to buy—it is quite remarkably inexpensive to run and maintain. Though a full-sized, roomy, well-proportioned car, there is no superfluous weight about this very practical “six.” Specialisation has left its mark here. The engine—the chassis frame—the coachwork—all are notable examples of specialised engineering and constructional skill. We claim, without fear of contradiction, that no other small “six” to-day can offer such a well-matched combination of performance, comfort and economy.

**GENERAL EQUIPMENT.** Toughened Triplex glass throughout ; finger-tip controls for ignition, lamps and horn ; direction indicators ; Lockheed hydraulic brakes ; pile carpets ; pedal rubbers ; gearbox draught excluders ; pedal draught excluders ; speedometer ; oil gauge ; S.U. electric pressure petrol pump ; dash-reading electric petrol gauge ; electric windscreen wiper ; pressure chassis lubricating pump ; calorimeter and wings ; high-frequency electric horn ; electric lighting and starting ; stop and tail-light ; headlamps with dip and switch mechanism ; sidelamps ; battery master switch ; scuttle side ventilators ; hydraulic shock absorbers ; door pockets ; five detachable disc type wheels ; five Dunlop extra low-pressure cord tyres ; spare wheel carrier ; spare wheel cover ; jack ; tyre pump ; kit of tools.

## THE MORRIS TEN SIX TWO-SEATER

**Coachwork.** Green cellulose with green leather upholstery ; Black cellulose with green leather upholstery ; Red cellulose with red leather upholstery. (Karhyde on dickey seat.)

**Interior Woodwork.** Polished mahogany.

**Additional Equipment.** Hood, hood bag, bumpers front and rear, double-panel adjustable windscreen, detachable sidescreens, adjustable single-piece seat, external driving mirror, spare wheel cover.

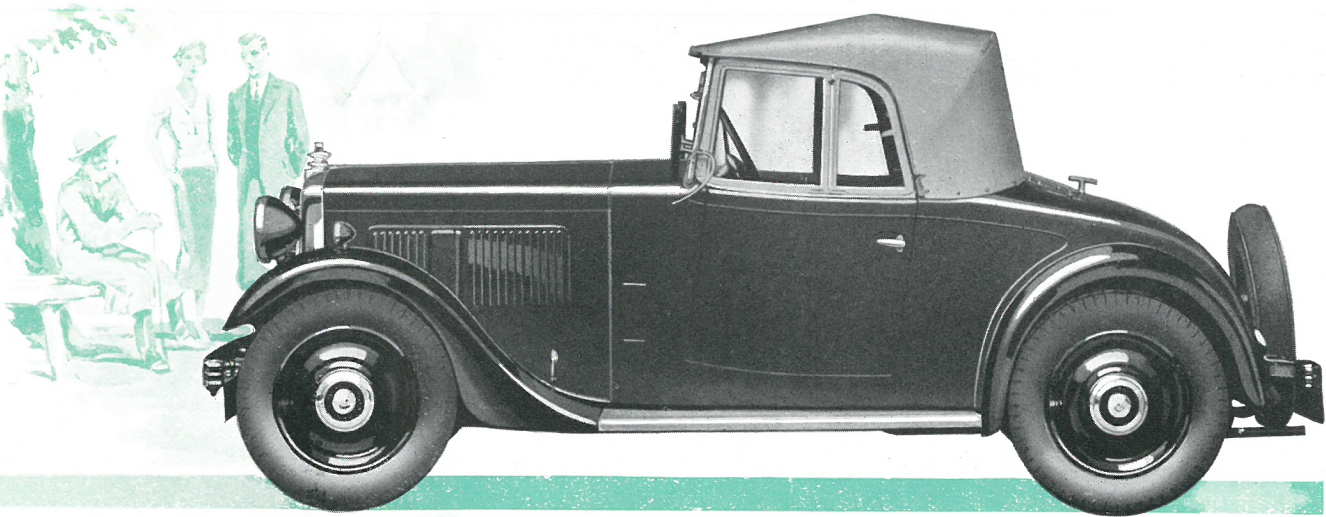

## THE MORRIS TEN SIX TOURER

**Coachwork.** Green cellulose with green leather upholstery ; Black cellulose with green leather upholstery ; Red cellulose with red leather upholstery.

**Interior Woodwork.** Polished mahogany.

**Additional Equipment.** Hood, hood bag, bumpers front and rear, double-panel adjustable windscreen, detachable sidescreens, external driving mirror, single-piece adjustable front seat, luggage grid, spare wheel cover.

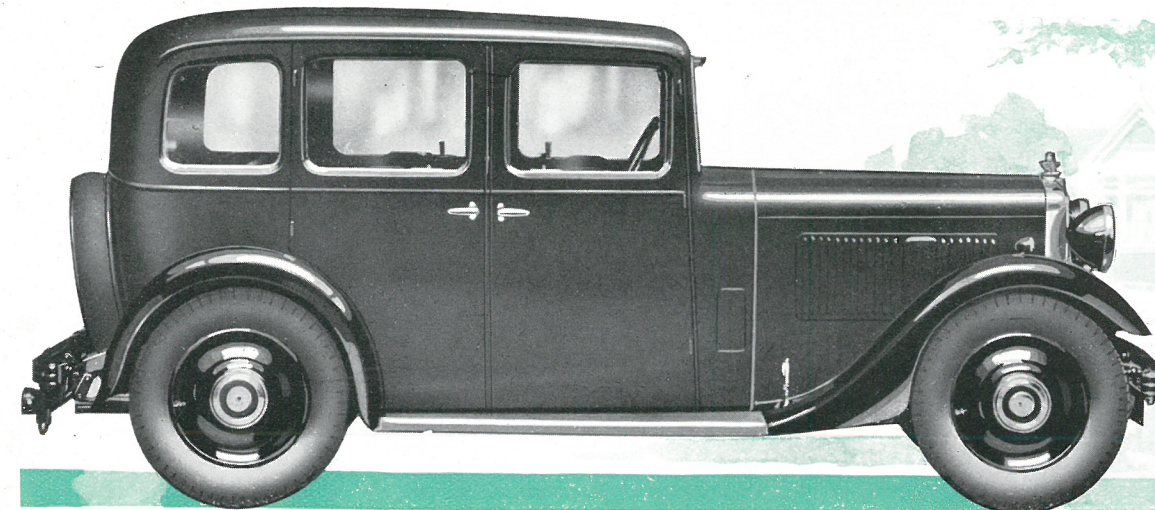
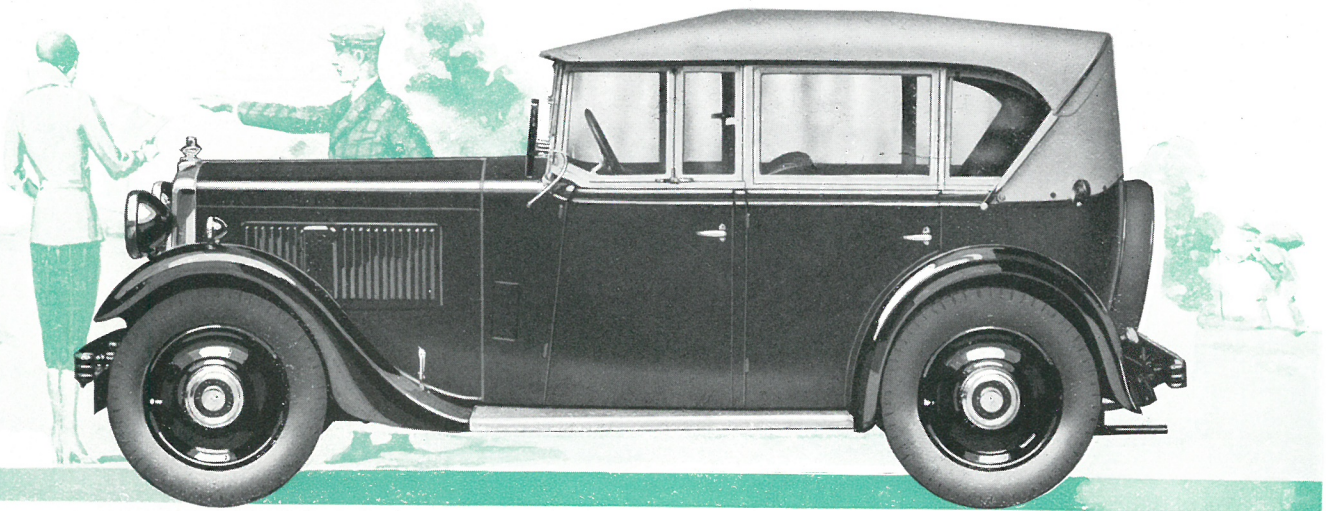

## THE MORRIS TEN SIX SALOON (Fixed Head)

**Coachwork.** Blue cellulose with blue leather upholstery ; Green/Black cellulose with green leather upholstery ; Black cellulose with green leather upholstery ; Red/Black cellulose with red leather upholstery.

**Interior Woodwork.** Polished mahogany.

**Additional Equipment.** Luggage grid, single-panel adjustable windscreen, winding door-windows, interior driving mirror, Trafficator mirrors, concealed rear blind with remote control, pillar pull cords, private locks on all doors, adjustable bucket type front seats, roof-lamp, spare wheel cover, driver's sun blind, bumpers front and rear, art silk parcel net.

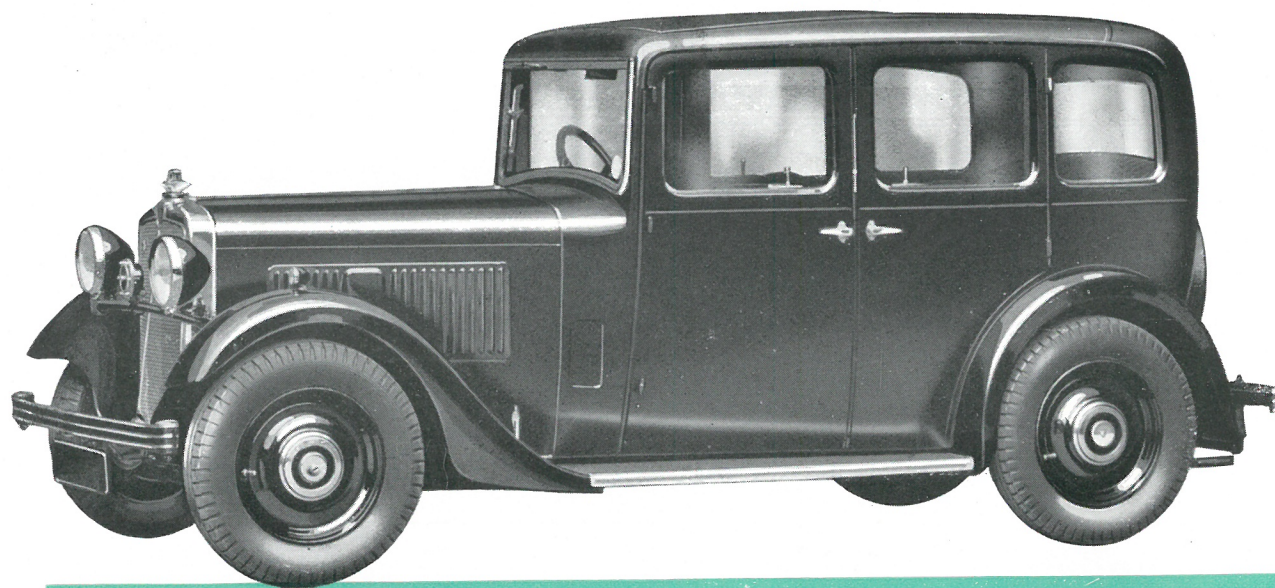

## THE MORRIS TEN SIX SALOON (*Sliding Head*)

**Coachwork.** Blue cellulose with blue leather upholstery; Green/Black cellulose with green leather upholstery; Black cellulose with green leather upholstery; Red/Black cellulose with red leather upholstery.

**Interior Woodwork.** Polished mahogany.

**Additional Equipment.** Pytchley sliding head, single-panel adjustable windscreen, winding door-windows, interior driving mirror, Trafficator mirrors, concealed rear blind with remote control, pillar pull cords, private locks on doors, adjustable bucket type front seats, roof-lamp, spare wheel cover, driver's sun blind, luggage grid, bumpers front and rear.

## THE MORRIS TEN SIX SPECIAL COUPÉ (*Sliding Head*)

**Coachwork.** Green duotone cellulose with green leather upholstery; Brown duotone cellulose with brown leather upholstery; Cream/Green cellulose with green leather upholstery; All Black cellulose with brown leather upholstery.

**Interior Woodwork.** Figured walnut, semi-matt finish.

**Additional Equipment.** Pytchley sliding head, bumpers front and rear, single-panel adjustable windscreen, winding door-windows, interior driving mirror, Trafficator mirrors, rear blind with remote control, art silk pillar pull cords, private locks on doors, bucket type adjustable front seats, pneumatic cushion to rear seat, inbuilt luggage container, roof-lamp, spare wheel cover, driver's sun blind.

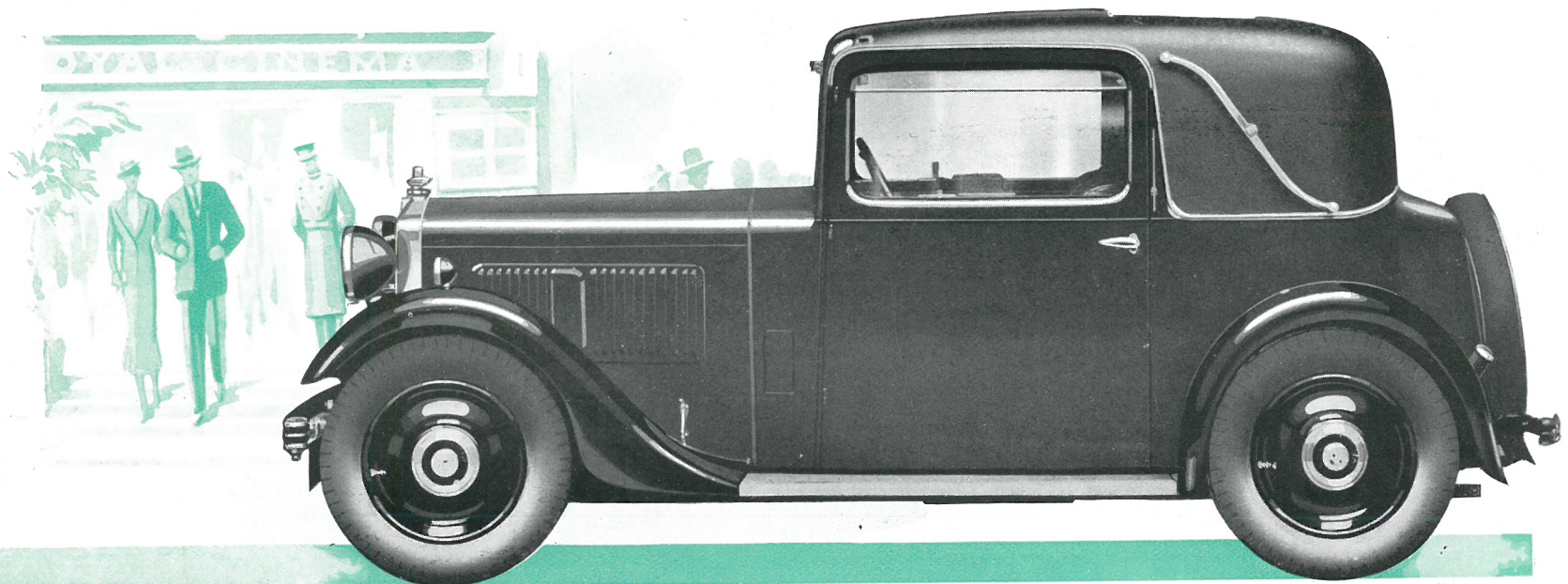

# GENERAL DATA FOR ALL MODELS

	Morris Eight	Morris Ten Four	Morris Ten Six	Morris Twelve Four	Morris Fifteen Six	Morris Oxford Twenty Six
<b>Number of Cylinders</b> ... ..	Four	Four	Six	Four	Six	Six
<b>Bore</b> ... ..	2.24 in. (57 mm.)	2.5 in. (63.5 mm.)	2.24 in. (57 mm.)	2.73 in. (69.5 mm.)	2.5 in. (63.5 mm.)	2.87 in. (73 mm.)
<b>Stroke</b> ... ..	3.54 in. (90 mm.)	4.01 in. (102 mm.)	3.54 in. (90 mm.)	4.01 in. (102 mm.)	4.01 in. (102 mm.)	4.01 in. (102 mm.)
<b>Cubic Capacity</b> ... ..	56 cu. in. (918 c.c.)	78.84 cu. in. (1292 c.c.)	84.1 cu. in. (1378 c.c.)	94.59 cu. in. (1550 c.c.)	117.27 cu. in. (1938 c.c.)	156.28 cu. in. (2561 c.c.)
<b>Valve Position</b> ... ..	Side	Side	Side	Side	Side	Side
<b>R.A.C. Rating</b> ... ..	8.05	10	12	11.9	15	20
<b>Number of Gears</b> ... ..	Three and Reverse	Four and Reverse	Four and Reverse	Four and Reverse	Four and Reverse	Four and Reverse
<b>Gear Ratios</b>						
<b>First</b> ... ..	17.13	20.88	22.2	20.88	20.88	21.08
<b>Second</b> ... ..	9.729	12.32	13.09	12.32	11.9	12.0
<b>Third</b> ... ..	5.375	7.986	8.49	7.976	7.75	7.79
<b>Fourth</b> ... ..	—	5.22	5.55	5.22	5.22	5.27
<b>Reverse</b> ... ..	22.84	26.845	28.54	26.845	26.1	26.35
<b>Clutch</b> ... ..	Single dry plate	Single plate (cork inserts)	Single plate (cork inserts)	Single plate (cork inserts)	Single plate (cork inserts)	Single plate (cork inserts)
<b>Steering Gear</b> ... ..	Bishop cam	Bishop cam	Bishop cam	Bishop cam	Bishop cam	Bishop cam
<b>Turning Circle</b> ... ..	37 ft. (11.28 m.)	38 ft. 1 in. (11.6 m.)	40 ft. 6 in. (12.34 m.)	40 ft. 10 in. (12.45 m.)	42 ft. 0 in. (12.8 m.)	45 ft. 4 in. (13.8 m.)
<b>Wheel Type</b> ... ..	Magna Wire	Disc	Disc	Disc	Disc	Magna Wire
<b>Wheel Size</b> ... ..	3.00×16	3.50×16	3.50×16	4.00×16	4.00×16	4.5×16
<b>Tyre Size</b> ... ..	5.25—16	5.75—16	5.75—16	6.00—16	6.00—16	7.00—16
<b>Wheelbase</b> ... ..	7 ft. 6 in. (2.29 m.)	8 ft. 0 in. (2.435 m.)	8 ft. 6 in. (2.59 m.)	8 ft. 6 in. (2.59 m.)	8 ft. 10 in. (2.692 m.)	9 ft. 6 in. (2.896 m.)
<b>Track</b> ... ..	3 ft. 9 in. (1.14 m.)	4 ft. 0 in. (1.219 m.)	4 ft. 0 in. (1.219 m.)	4 ft. 0 in. (1.219 m.)	4 ft. 4 in. (1.321 m.)	4 ft. 8 in. (1.422 m.)
<b>F.W.B. Brake Actuation</b> ... ..	Hydraulic	Hydraulic	Hydraulic	Hydraulic	Hydraulic	Hydraulic
<b>Hand Brake Actuation</b> ... ..	On rear wheels	On rear wheels	On rear wheels	On rear wheels	On rear wheels	On rear wheels
<b>Brake-drum Diameter</b> ... ..	8 in. (203 mm.)	10 in. (254 mm.)	10 in. (254 mm.)	10 in. (254 mm.)	10 in. (254 mm.)	12 in. (305 mm.)
<b>Ignition</b> ... ..	Coil	Coil	Coil	Coil	Coil	Coil
<b>Final Drive</b> ... ..	Spiral Bevel	Spiral Bevel	Spiral Bevel	Spiral Bevel	Spiral Bevel	Spiral Bevel
<b>Front Springs</b> ... ..	Half Elliptic	Half Elliptic	Half Elliptic	Half Elliptic	Half Elliptic	Half Elliptic
<b>Rear Springs</b> ... ..	Half Elliptic	Half Elliptic	Half Elliptic	Half Elliptic	Half Elliptic	Half Elliptic
<b>Shock Absorbers</b> ... ..	Hydraulic	Hydraulic	Hydraulic	Hydraulic	Hydraulic	Hydraulic
<b>Tank Capacity</b> ... ..	5½ gallons (25 litres)	6½ gallons (29½ litres)	6½ gallons (29½ litres)	7½ gallons (34 litres)	10 gallons (45 litres)	14 gallons (63½ litres)
<b>Petrol Feed</b> ... ..	S.U. Electric Pump	S.U. Electric Pump	S.U. Electric Pump	S.U. Electric Pump	S.U. Electric Pump	S.U. Electric Pump

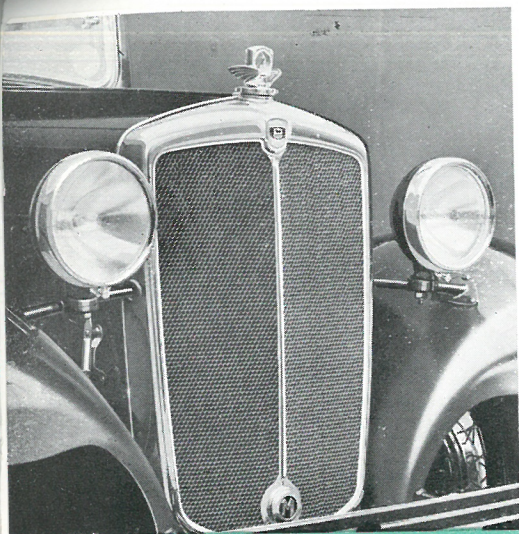

# Morris Twelve-four ... *a tribute to Precision*

## *Manufacture made possible by* Specialisation...

SALOON .. ..  
(Fixed Head)

SALOON .. ..  
(Sliding Head)

The claim that a "four" is as smooth as a "six" has been idly and far too often made. Suffice it to say of this Morris Twelve Four that it is smoother than you ever thought a "four" could be. As you put down your foot and the car glides eagerly forward, you are hardly conscious of the source of power. The car seems wafted rather than propelled. You wait in vain for the slightest tremor or throb. Only engine *specialists* could have made such an engine.

And Specialisation has left its mark on every other detail of this Morris Twelve Four; on the chassis—so well balanced and suspended that rough roads pass unnoticed; on the coachwork—fashioned and finished like a work of art. This one model alone is enough to prove the case for Specialisation.

**GENERAL EQUIPMENT.** Toughened Triplex glass throughout; draughtless ventilation mechanism to front door-windows; driver's sun blind; finger-tip controls for ignition, lamps and horn; concealed direction indicators; Lockheed hydraulic brakes; adjustable single-panel windscreen; pile carpets; pedal rubbers; gearbox draught excluders; pedal draught excluders; winding door-windows; interior driving mirror; Trafficator mirrors; concealed rear blind with remote control; art silk pillar pull cords; private locks on doors; speedometer; oil gauge; electric pressure petrol pump; dash-reading electric petrol gauge; electric windscreen wiper; pressure chassis lubricating pump; calorimeter and wings; high-frequency electric horn; electric lighting and starting; compensated voltage control; stop and tail-light; headlamps with dip and switch mechanism; sidelamps; roof-lamp; battery master switch; scuttle side ventilators; hydraulic shock absorbers; door pockets; five detachable disc type wheels; five Dunlop extra low-pressure cord tyres; spare wheel carrier; jack; tyre pump; kit of tools.

## THE MORRIS TWELVE FOUR SALOON (*Fixed Head*)

**Coachwork.** Blue cellulose with blue leather upholstery; Green/Black cellulose with green leather upholstery; Black cellulose with green leather upholstery; Red/Black cellulose with red leather upholstery.

**Interior Woodwork.** Polished mahogany.

**Additional Equipment.** Parcel net, bumpers front and rear, luggage grid.



## THE MORRIS TWELVE FOUR SALOON (*Sliding Head*)

**Coachwork.** Blue cellulose with blue leather upholstery; Green/Black cellulose with green leather upholstery; Black cellulose with green leather upholstery; Red/Black cellulose with red leather upholstery.

**Interior Woodwork.** Polished mahogany.

**Additional Equipment.** Pytchley sliding head; bumpers front and rear, luggage grid.

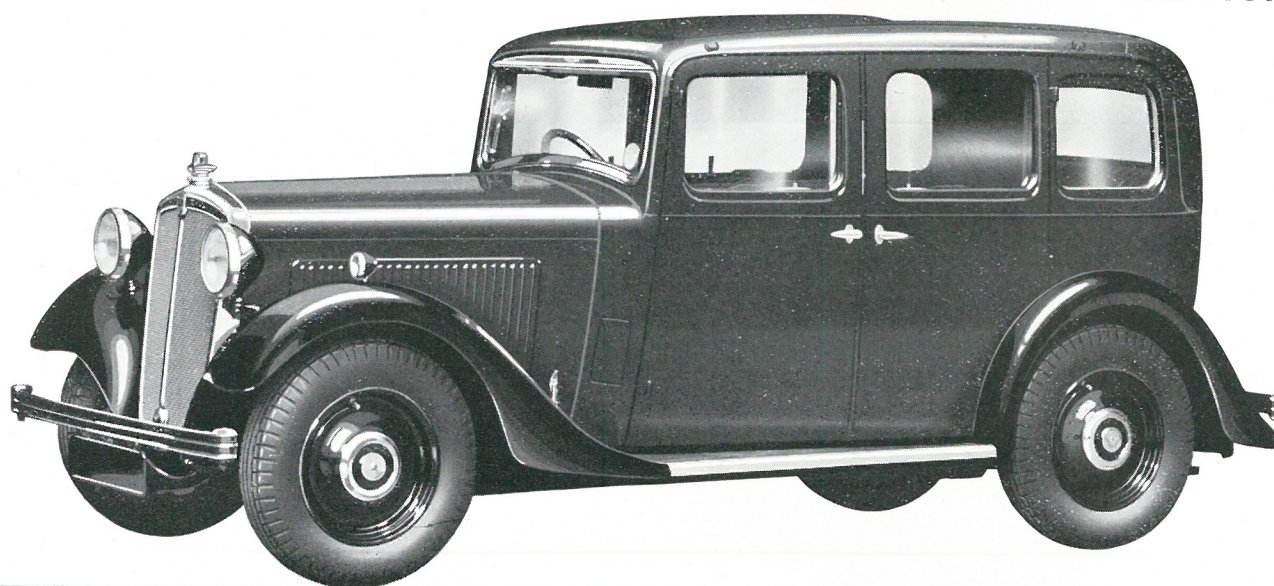



# Morris Fifteen-six *...an attractively priced six with an exceptional performance...*

SALOON .. ..  
(Fixed Head)

SALOON .. ..  
(Sliding Head)

SPECIAL COUPÉ ..  
(Sliding Head)

This model is what the experienced motorist would call a "handy" car—for its excellent power/weight ratio makes it really lively and delightful to drive. Though a roomy, dignified car, it weaves a nimble way through traffic. Yet get this car on a wide, straight stretch and it soon shows that flexibility is not its only good quality. This Fifteen Six is the car for the man who travels far and often; who thinks of his friends as neighbours if they live within a hundred miles. It is no small credit to Specialisation that such a car can be offered at so moderate a price.

**GENERAL EQUIPMENT.** Toughened Triplex glass throughout; driver's sun blind; thermostatic temperature control for cooling water; finger-tip controls for ignition, lamps and horn; concealed direction indicators; Lockheed hydraulic brakes; adjustable single-panel windscreen; pile carpets; pedal rubbers; gearbox draught excluders; pedal draught excluders; winding door-windows; interior driving mirror; Trafficator mirrors; concealed rear blind with remote control; art silk pillar pull cords; private locks on doors; speedometer; oil gauge; S.U. electric pressure petrol pump; dash-reading electric petrol gauge; electric windscreen wiper; pressure chassis lubricating pump; calormeter and wings; high-frequency electric horn; electric lighting and starting; compensated voltage control; stop and tail-light; headlamps with dip and switch mechanism; sidelamps; roof-lamp; battery master switch; scuttle side ventilators; hydraulic shock absorbers; door pockets; five detachable disc type wheels; five Dunlop extra low-pressure cord tyres; spare wheel carrier; spare wheel cover; jack; tyre pump; kit of tools.

## THE MORRIS FIFTEEN SIX SALOON

(Fixed Head)

**Coachwork.** Blue cellulose with blue leather upholstery ; Green/Black cellulose with green leather upholstery ; Black cellulose with green leather upholstery ; Red/Black cellulose with red leather upholstery.

**Interior Woodwork.** Polished mahogany.

**Additional Equipment.** Bumpers front and rear, luggage grid, spare wheel cover, draughtless ventilation mechanism to front door-windows, frameless louvres.

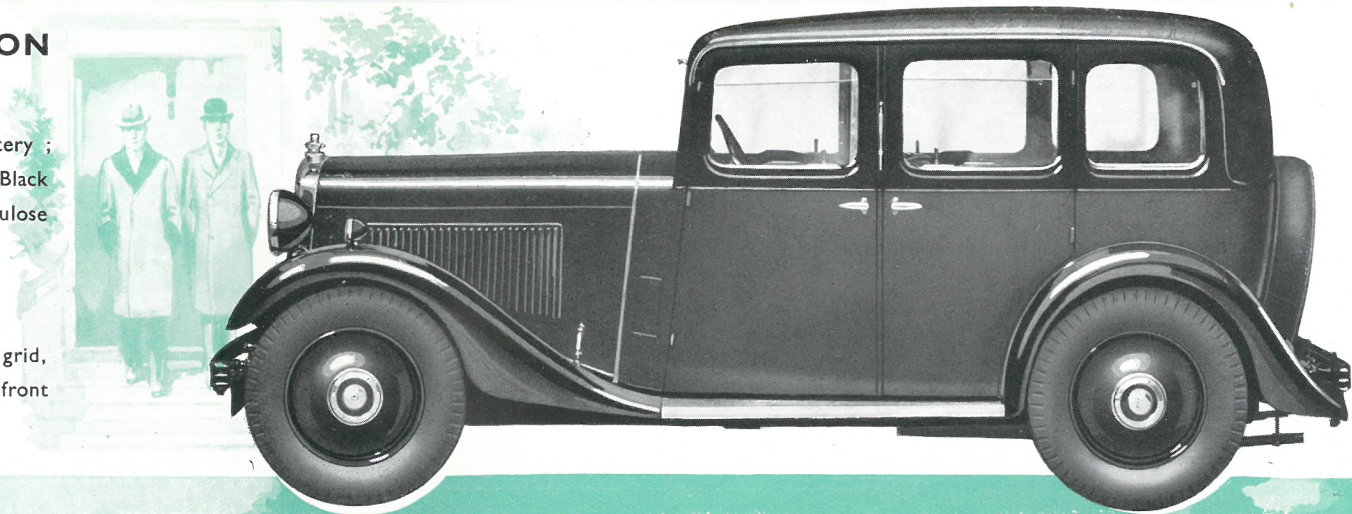

## THE MORRIS FIFTEEN SIX SALOON

(Sliding Head)

**Coachwork.** Blue cellulose with blue leather upholstery ; Green/Black cellulose with green leather upholstery ; Black cellulose with green leather upholstery ; Red/Black cellulose with red leather upholstery.

**Interior Woodwork.** Polished mahogany.

**Additional Equipment.** Pytchley sliding head, bumpers front and rear, luggage grid, spare wheel cover, draughtless ventilation mechanism to front door-windows.

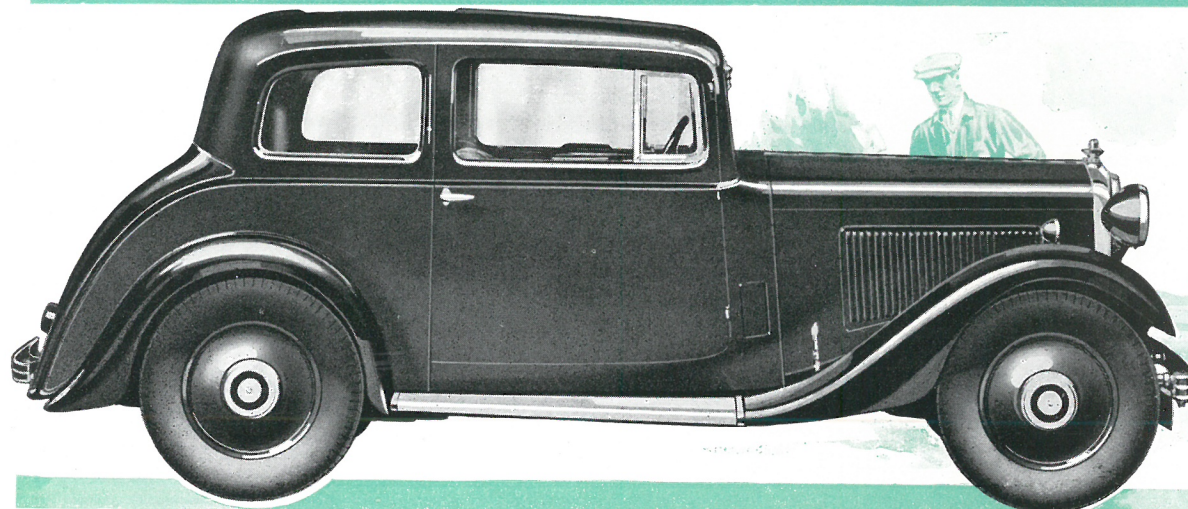
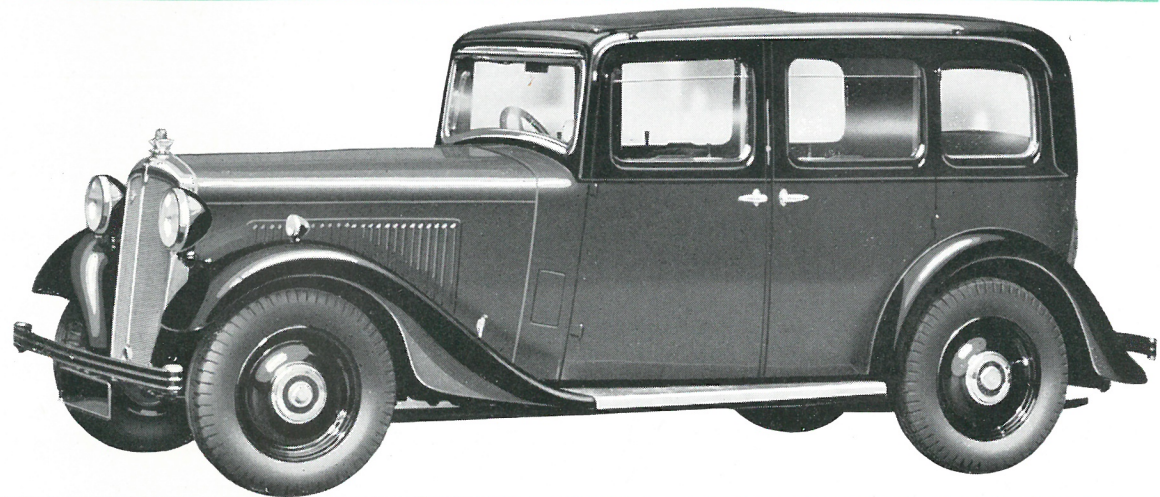

## THE MORRIS FIFTEEN SIX SPECIAL COUPÉ

(Sliding Head)

**Coachwork.** Green duotone cellulose with green leather upholstery ; Brown duotone cellulose with brown leather upholstery ; Cream/Green cellulose with green leather upholstery ; All Black cellulose with brown leather upholstery.

**Interior Woodwork.** Burr walnut.

**Additional Equipment.** Pneumatic cushion to rear seat, Pytchley sliding head, folding centre arm-rest to rear seat, three ashtrays, inbuilt luggage container, ventilating windows in doors, bumpers front and rear, spare wheel cover.



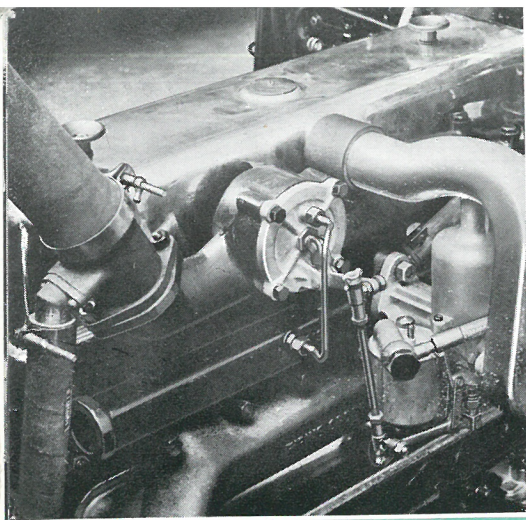

# Morris Oxford 'Twenty'

## Specialisation's *supreme achievement* .....

SALOON .. ..  
(Sliding Head)

SPECIAL COUPÉ ..  
(Sliding Head)

The most attractive models in the Morris range, the Morris Oxfords give perhaps the most striking proof of the superiority of Specialised production. These are the kind of cars that discerning people pause to admire.

Specialisation has given these cars a degree of comfort, fleetness, and smoothness comparable only with the most costly cars of the day. Ensnconced in one of their superbly appointed interiors, you feel at once a sense of security and well-being. The controls fall so readily to hand that the driver is just as much at ease as are his passengers. So smooth are these big Morris "Sixes" that speed is at last divorced from sensation of speed. So smooth and progressive are the powerful brakes that emergencies seem to eliminate themselves. To travel in one of these cars is to travel with none of motoring's usual worry and flurry. They are cars that stand for all that is best in design, technique and craftsmanship; cars that would cost four-figure sums were it not for Morris Specialisation.

**GENERAL EQUIPMENT.** Toughened Triplex glass throughout; Pytchley sliding head, roof wired for radio; finger-tip controls for lamps and horn; fully automatic ignition control; thermostatic control for cooling water circulation; thermostatic mixture control; direction indicators with automatic release switch; Lockheed hydraulic brakes; single-panel adjustable windscreen; adjustable bucket front seats; pile carpets; concealed rear blind with remote control; driver's sun blind; interior driving mirror; Trafficator mirrors; pedal rubbers; gearbox draught excluders; pedal draught excluders; speedometer with trip; oil gauge; dash-reading electric petrol gauge; two-bladed electric windscreen wiper; pressure chassis lubricating pump; calorimeter and wings; bumpers front and rear; high-frequency electric horn; electric lighting and starting; compensated voltage control; free wheel with locking control; automatic clutch with control; fog-lamp; stop, tail and reverse lamp; battery master switch; S.U. electric pressure petrol pump; Luvax hydraulic shock absorbers; Lucas Biflex headlamps with dip and switch mechanism; sidelamps; roof-lamp; pillar pull cords; private locks on doors; scuttle side ventilators; door pockets; spare wheel carrier; spare wheel cover; jack; tyre pump; kit of tools; five detachable Magna type wire wheels; five Dunlop extra low-pressure cord tyres.

## THE MORRIS OXFORD TWENTY SALOON (*Sliding Head*)

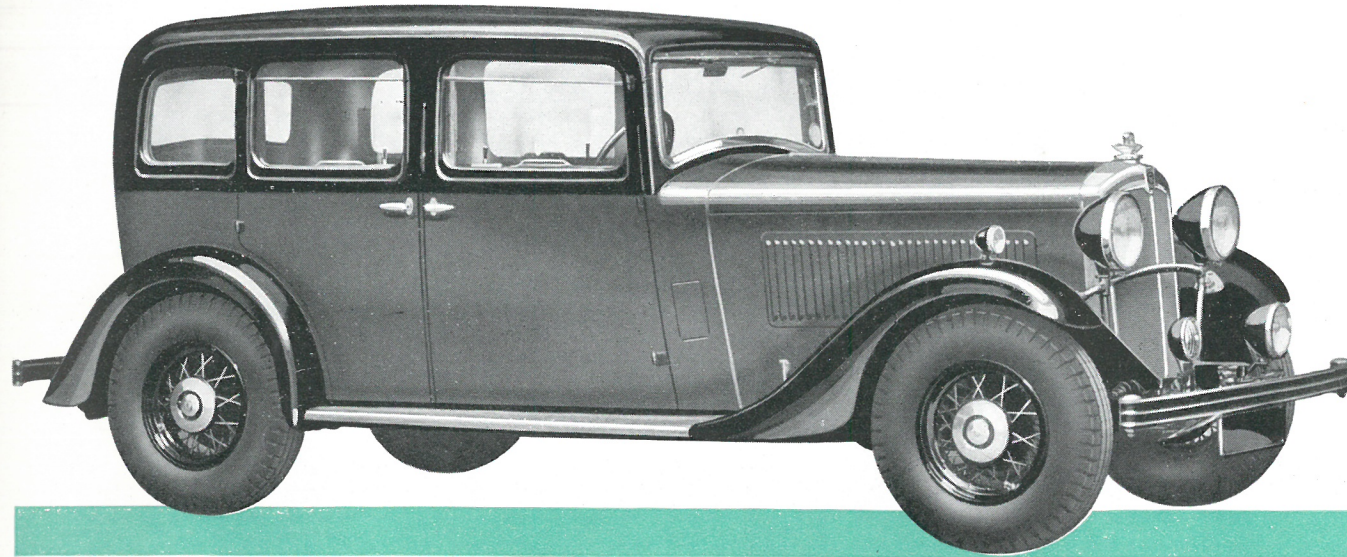

**Coachwork.** Blue/Black cellulose with blue leather upholstery ; Red/Black cellulose with red leather upholstery ; Green/Black cellulose with green leather upholstery ; All Black cellulose with brown leather upholstery.

**Interior Woodwork.** Burr walnut, semi-matt finish.

**Additional Equipment.** Luggage grid, two head-rest cushions, folding centre arm-rest to rear seat, pneumatic cushion to rear seat, three ashtrays, blinds to quarter windows, winding door-windows with draughtless ventilation mechanism to front door-windows, frameless louvres.

## THE MORRIS OXFORD TWENTY SPECIAL COUPÉ (*Sliding Head*)

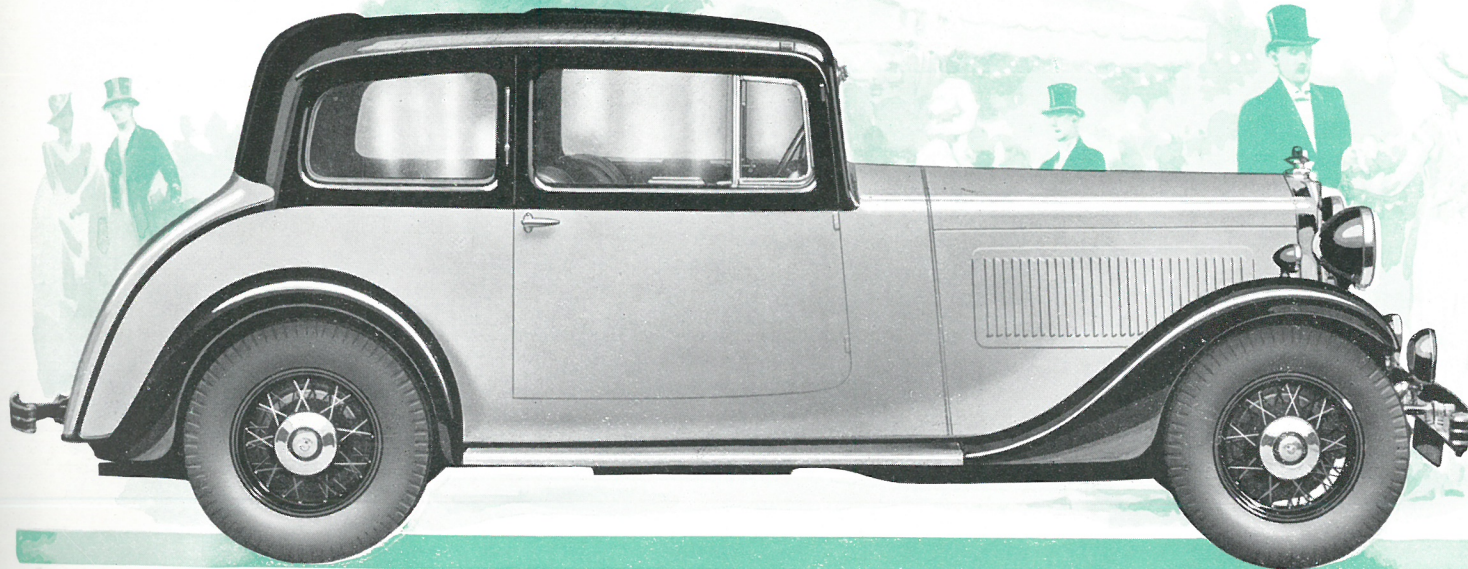

**Coachwork.** Green duotone cellulose with green leather upholstery ; Brown duotone cellulose with brown leather upholstery ; Cream/Green cellulose with green leather upholstery ; All Black cellulose with brown leather upholstery.

**Interior Woodwork.** Burr walnut.

**Additional Equipment.** Pneumatic cushion to rear seat, folding centre arm-rest to rear seat, inbuilt luggage container, three ashtrays, ventilating windows, winding door-windows.

# SPECIFICATIONS OF ALL MODELS

## THE MORRIS EIGHT

**General.** The Morris Eight does not differ in general design from a big car. It possesses a sound and exceptionally efficient four-cylinder water-cooled engine built in unit construction with a totally enclosed three-speed synchromesh gearbox, a full length downswept box sectioned frame of special design with semi-elliptic springs front and rear of generous dimensions, hydraulic shock absorbers, hydraulic brakes, and a rear axle of the three-quarter floating type with spiral bevel final reduction gears and differential. The transmission from the gearbox to the rear axle is by a large diameter tubular propeller shaft and fabric universal joints with centring steadies. The track is 3 ft. 9 in. (1.14 m.) and the wheelbase 7 ft. 6 in. (2.29 m.).

**Engine.** The four-cylinder engine has a bore of 57 mm. (2.25 in.), stroke 90 mm. (3.54 in.), and a cubic capacity of 918 c.c. (56.7 cu. in.). It is mounted on improved equipose suspension. The cylinders are cast in one with the upper half of the crankcase, which is extended well below the crankshaft centre to ensure maximum stiffness. The cylinders are provided with a detachable head, facilitating decarbonisation, and the combustion spaces are of the most advanced formation to provide the highest possible efficiency. Side valves operated by adjustable tappets from a three-bearing camshaft of unusually generous diameter are fitted, and the camshaft is driven by a silent duplex roller chain from the crankshaft. The large diameter three-bearing crankshaft has steel backed white metal bearings of the largest possible dimensions. Every crankshaft is carefully balanced to very close limits, both statically and dynamically. Steel connecting rods of "I" section and aluminium pistons of the three-ring type are fitted. The lower piston ring is of the oil-return pattern, and piston and connecting rod assemblies are equalised in weight to within .2 oz. (best aero engine practice). 14 mm. spark plugs are fitted.

**Cooling System.** The cooling water circulates by thermo-syphon action through large ports which are carefully positioned to obviate steam pockets. The radiator is fan assisted.

**Clutch.** A single-plate clutch of the dry type with cushion hub is built in unit construction with the engine and gearbox. It requires the very minimum of attention and is exceptionally smooth in action. Operation of the clutch is particularly light and suited to lady drivers.

**Synchromesh Gearbox.** The gearbox provides three forward speeds and reverse with synchromesh mechanism for top and second gears. All gears are of nickel steel and accurately finished. Gear selection is by central lever. The gearbox is provided with an accessible oil filling orifice and dipstick oil level indicator. Lubrication attention can therefore be given without disturbing the floorboards.

**Lubrication.** The engine is automatically lubricated by a spur gear pump mounted internally and positioned low down so that it is immune from priming troubles. The pump is driven by helical gearing direct from the camshaft, and all oil is effectively filtered before circulation by a large oil filter. Oil is delivered under pressure to the main, big-end and camshaft bearings, and a special oil feed is provided for the camshaft driving chain. Enots high-pressure chassis lubrication by accessible nipples is employed.

**Carburation.** The working mixture is supplied by S.U. carburetter of the automatic piston type. The petrol supply is carried in a 5½ gallon (25 litres) tank mounted at the rear of the chassis, and the petrol is fed to the carburetter by an S.U. automatic electric pressure pump. The inlet and exhaust manifolds are an integral casting, with adequate hot spot. Wide control over the mixture strength is provided by a conveniently-operated control. The petrol tank is equipped with a dash-reading electric petrol gauge.

**Transmission.** The drive from the gearbox to the rear axle is by a balanced tubular propeller shaft of large diameter fitted with fabric disc universal joints at each end having centring steadies. The final drive gears are of the silent spiral bevel pattern, and are mounted with the differential in a sturdy pressed-steel rear axle.

**The Four-wheel Brakes.** The foot brake operates internal-expanding shoes on all four wheels by the Lockheed hydraulic system. The brakes are extremely light in operation, smooth in action, and fully compensated. Their adjustment is simple and there are no bearings or cross shafts needing lubrication attention. A centrally disposed horizontal hand brake lever operates the steel shoes in the rear drums by a short cross shaft and cable. The hand brake is provided with instantaneous adjustment from the driver's seat.

**Steering.** The steering gear is of the Bishop cam type, which provides exceptional lightness of steering control with extreme accuracy, and reduces the transmission of road shocks to the steering wheel to a minimum. Left-hand drive available on all models.

**Electrical Equipment.** Ignition is supplied by a Lucas 6-volt battery and coil, the distributor being provided with automatic control for advance and retard. Current for the battery and lighting system is produced by a Lucas dynamo of exceptionally large dimensions (4½ in. diameter) which cuts in at low road speeds. The starter motor is of the sliding pinion type and mounted direct to the flywheel housing. Full five-lamp equipment is provided, including headlamps with dimming mechanism, sidelamps and tail-light. The electrical equipment incorporates in addition concealed traffic indicators, ammeter, electric screen wiper, electric horn, instrument panel illumination, and ignition warning light.

**Wheels.** Five detachable Magna type wire wheels fitted with 5.25×16 Dunlop extra low-pressure cord tyres are provided. The wheels have six-stud fixing.

**Suspension.** Long semi-elliptic springs are fitted front and rear and are fully controlled by shock absorbers of the Armstrong hydraulic type with improved automatic cold weather regulation. The front shock absorbers are mounted "outboard."

**Tool Kit.** A kit of tools is provided with every car and housed in an accessible toolbox on the dash under the bonnet.

## THE MORRIS TEN FOUR

**General.** The design consists of a four-cylinder water-cooled engine built in unit construction with a four-speed synchromesh gearbox and single-plate clutch with cork inserts. This power unit is mounted on a deep sectioned down-swept frame with generous "X" stiffening members on a resilient equipoise mounting which reduces engine vibrations. The frame is supported front and rear on long semi-elliptic springs controlled by Armstrong hydraulic shock absorbers. The track is 4 ft. 0 in. (1.22 m.) and the wheelbase 8 ft. 0 in. (2.43 m.).

**Engine.** The four-cylinder engine has a bore of 63.5 mm. (2.5 in.), a stroke of 102 mm. (4.0 in.) and a cubic capacity of 1292 c.c. (78.84 cu. in.). Treasury rating 10 h.p. The cylinders are cast in one with the skirt of the crankcase, which is extended well below the crankshaft centre, and liberally reinforced with internal webs to provide a structure of great strength and rigidity. The crankshaft is of the three-bearing type, with bearings of large diameter and generous length. Every crankshaft is carefully balanced to very close limits. The main bearings are die-cast white metal. The steel connecting rods are equipped with white metal big-end bearings of the full-ring type, and are individually balanced to a very high degree of accuracy. The aluminium pistons are fitted with four rings, individually balanced, and the complete assemblies of rods and pistons are equalised in weight to within .2 oz. (best aero engine practice). The side-by-side valves are operated by a large diameter three-bearing camshaft through adjustable tappets carried in removable guides. The combustion chambers are completely machined to ensure equality of compression and the minimum of carbon deposits, the cylinder head being detachable. The camshaft is driven by duplex roller chain from the crankshaft. The induction and exhaust manifolds are cast integral and provided with adequate hot spots. An important feature of the induction system is the combined air preheating cover and cleaner, which also collects and consumes all fumes discharged from the crankcase breather, so that they are prevented from finding their way into the car interior.

**Synchromesh Gearbox.** The four-speed gearbox is provided with synchromesh mechanism for top and third gears, which are, in addition, of the silent constant mesh type. The gearbox is provided with an accessible filling orifice and dipstick oil level indicator.

**Lubrication.** A spur gear pump, mounted externally on the side of the crankcase and driven from the camshaft by a diagonal shaft and helical gearing, supplies oil under pressure to all main and big-end bearings, camshaft bearings and clutch. The oil is filtered before recirculation by a generous tray type filter covering the full area of the sump. Chassis lubrication is by Enots high-pressure oilgun in conjunction with accessible nipples.

**Cooling System.** The cooling water circulates by thermo-syphon action. It is passed from the cylinder head through two carefully positioned ports which ensure an even temperature distribution and absence of steam pockets. The radiator is fan assisted.

**Electrical Equipment.** The distributor for the coil and battery ignition is driven from the upper end of the diagonal oil pump drive shaft, and has semi-automatic advance and retard. The dynamo is belt driven. The starter motor is of the sliding pinion type and located on the side of the gearbox. Full five-lamp equipment is provided, including headlamps with dip and switch mechanism, sidelamps, and tail-light with automatic stop light. All switches are accessibly mounted on the instrument panel with the exception of the headlight dipping switch and horn push, which are conveniently mounted in the centre of the steering wheel, and the battery master switch which is close to the driver's seat. An easily controlled electric wind-screen wiper ensures clear vision in bad weather, and concealed type traffic indicators are fitted, except on the open models, where they are mounted on the screen pillar.

**Carburation.** An S.U. automatic piston-type carburettor with adequate control over mixture strength supplies the mixture. The controls are conveniently situated on the fascia board.

**Petrol Tank.** The petrol tank is mounted at the rear of the chassis and has a capacity of 6½ gallons (29½ litres). Its contents are clearly indicated to the driver by an electrically-operated dial gauge on the instrument panel. The petrol feed is by S.U. automatic electric pressure pump.

**Transmission.** A cushioned hub single-plate clutch, with cork inserts, automatically fed with oil from the engine, ensures a smooth clutch action and the minimum of attention. An open tubular propeller shaft, carefully balanced and of large diameter, transmits the drive to the rear axle through fabric disc universal joints with centring steadies. The final drive is by silent spiral bevel gears and differential housed in a pressed-steel axle casing. The axle shafts are three-quarter floating.

**The Four-wheel Brakes.** Fully compensated four-wheel brakes of the internally expanding type operated by the Lockheed hydraulic system ensure the maximum braking efficiency. Their certainty of action is maintained under all conditions as there are no bearings to wear or need lubrication. The centrally disposed horizontal hand brake lever operates on the rear wheels by independent mechanism, and is provided with instantaneous adjustment from the driver's seat.

**Steering.** The steering gear is of the Bishop cam type, providing extremely light and safe operation with a high degree of accurate controllability. Road shocks on the steering wheel are particularly absent. Left-hand drive available on all models.

**Controls.** The accelerator pedal is located on the extreme right (except on left-hand drive models), and the brake pedal and clutch pedal are positioned to provide ample clearance between the clutch pedal and the gear lever turret.

**Suspension.** Long semi-elliptic springs are fitted fore and aft and are controlled by Armstrong hydraulic shock absorbers with improved cold weather regulation.

**Wheels.** Five detachable disc type wheels fitted with 5.75—16 Dunlop extra low-pressure cord tyres are provided.

**Tool Kit.** A kit of tools is provided with every car and housed in an accessible toolbox on the dash under the bonnet.

## THE MORRIS TEN SIX

**General.** The design consists of a six-cylinder water-cooled engine built in unit construction with a single-plate clutch with cork inserts, and a four-speed gearbox with synchromesh mechanism for top and third gears. This power unit is mounted in a deep sectioned down-swept frame with generous "X" stiffening members by a resilient equipoise mounting which reduces engine vibrations. The chassis is supported front and rear on long semi-elliptic springs effectively controlled by hydraulic shock absorbers. The track is 4 ft. 0 in. (1.22 m.) and the wheelbase 8 ft. 6 in. (2.59 m.).

**Engine.** The six-cylinder engine has a bore of 57 mm. (2.25 in.), a stroke of 90 mm. (3.54 in.) and a cubic capacity of 1378 c.c. (84.1 cu. in.). Treasury rating 12 h.p. The cylinders are cast in one with the skirt of the crankcase which is extended well below the crankshaft centre and liberally reinforced with internal webs, producing a deep girder structure of great rigidity. The crankshaft possesses four bearings of generous dimensions and is carefully balanced to very fine limits. The main and big-end bearings are of white metal and of the full-ring shim-less type. Steel connecting rods of "I" section, individually balanced,

are fitted, and the complete assemblies of connecting rods and pistons are equalised in weight to .2 oz. (best aero engine practice). The aluminium pistons possess four rings. The side-by-side valves are actuated by adjustable tappets operated from a camshaft of large diameter which is driven from the crankshaft by a duplex roller chain. The combustion spaces are fully machined to ensure equality of compression and the minimum of carbon deposit. The cylinder head is detachable to facilitate decarbonising. The tappet guides are formed in three units which can be completely removed without disturbing any other component. The induction and exhaust manifolds are cast integral and provided with adequate hot spots. An important feature of the induction system is the combined air cleaning and preheating cover which also collects and consumes all fumes discharged from the crankcase breather.

**Synchromesh Gearbox.** The easy change gearbox is provided with synchromesh mechanism for top and third gears, which are, in addition, of the constant mesh silent type. The gearbox is provided with an accessible filling orifice and a dipstick level indicator, enabling lubrication attention to be given without disturbing the floorboards.

**Lubrication.** Oil is circulated under pressure by a spur gear type pump mounted externally on the side of the crankcase, and driven from the camshaft by a diagonal drive shaft and helical gears. The pump feeds the oil by suitable external and internal ducts to each of the main and big-end bearings, and to the camshaft bearings and clutch. The oil is thoroughly filtered before recirculation by a tray type filter of large size covering the whole area of the sump. Chassis lubrication is by Enots high-pressure oilgun and accessible oil nipples.

**Cooling System.** The cooling water circulates by thermo-syphon action. It passes from the cylinder head through three well-positioned ports of large dimensions which ensure even temperature distribution and the absence of steam pockets. The radiator is fan assisted.

**Electrical Equipment.** The distributor for coil and battery ignition is provided with semi-automatic advance and retard. The distributor is driven from the upper end of the oil pump drive shaft, which is extended for the purpose. The dynamo is mounted on a cradle on the off-side of the engine and belt driven from the crankshaft. It cuts in at low road speeds, and is provided with simple belt adjustment. The starter motor is of the sliding pinion type. Full five-lamp equipment, including headlamp with dip and switch mechanism, sidelamps, tail-light with automatic stop lamp, is fitted. All switches are accessibly mounted on the instrument panel with the exception of the headlight dipping switch and horn push, which are conveniently mounted in the centre of the steering wheel, and the battery master switch which is close to the driver's seat. An easily controlled electric windscreen wiper ensures a clear vision during bad weather, and concealed type traffic indicators are fitted, except on the open models, where they are fitted on the windscreen pillars.

**Carburation.** A carburettor of the S.U. automatic piston type with control over mixture strength is fitted. The control is situated in a convenient position on the facia board, together with the slow-running control.

**Petrol Tank.** The petrol tank is carried at the rear of the chassis and has a capacity of 6½ gallons (29½ litres). Its contents are indicated to the driver by an electrically-operated dial gauge on the instrument panel. The petrol is fed to the engine by an S.U. automatic electric pressure pump.

**Transmission.** The clutch is of the cushioned hub single-plate cork insert type running in oil, and is automatically fed with oil from the engine. It is exceptionally smooth in action and requires the minimum of attention. A large diameter balanced tubular propeller shaft transmits the power to the rear axle, and is fitted with fabric disc universal joints with centring steadies. The final drive is through silent spiral bevel gears and differential carried in a pressed-steel axle casing. The axle shafts are of the three-quarter floating type.

**The Four-wheel Brakes.** Lockheed hydraulic internal-expanding brakes are fitted to all four wheels. They are fully compensated, smooth, light and certain in action, and maintain their efficiency under all conditions as they have no bearings to wear or need lubrication. The centrally disposed horizontal hand brake lever operates on the rear wheels by independent mechanism, and is provided with instantaneous adjustment from the driver's seat.

**Steering.** The steering gear is of the Bishop cam type, which provides extremely light and safe operation with accurate controllability and immunity from the transmission of road shocks to the steering wheel. Left-hand drive available on all models.

**Controls.** The accelerator is situated on the extreme right (except on left-hand drive models), and the brake pedal and clutch pedal are positioned to provide ample clearance between the clutch pedal and the gear lever turret.

**Suspension.** Long semi-elliptic springs are fitted front and rear and are controlled by Armstrong hydraulic shock absorbers with improved automatic cold weather regulation.

**Wheels.** Five detachable disc type wheels fitted with 5.75—16 Dunlop extra low-pressure cord tyres are provided.

**Tool Kit.** A kit of tools is provided with every car and accessibly housed in a toolbox in the scuttle under the bonnet.

## THE MORRIS TWELVE FOUR

**General.** The design consists of a four-cylinder water-cooled engine with totally-enclosed single-plate clutch having cork inserts built in unit construction with a four-speed synchromesh gearbox. This power unit is carried in a sturdy downswept frame with generous "X" stiffening members on a resilient equipoise mounting which greatly reduces engine vibration. The frame is supported front and rear on long semi-elliptic springs effectively controlled by hydraulic shock absorbers. The track is 4 ft. 0 in. (1.22 m.) and the wheelbase 8 ft. 6 in. (2.59 m.).

**Engine.** The four-cylinder engine has a bore of 69.5 mm. (2.73 in.), a stroke of 102 mm. (4.0 in.), and a cubic capacity of 1550 c.c. (94.59 cu. in.). Treasury rating 11.9 h.p. The cylinders are cast in one with the skirt of the crankcase, which is extended well below the crankshaft centre and liberally reinforced with internal webs, producing a deep girder structure of great strength. The crankshaft is of the three-bearing type with bearings of large dimensions. Every crankshaft is balanced both statically and dynamically to very fine limits. Main and big-end bearings are of the shim-less full-ring type with white-metal lining. Steel connecting rods of "I" section are fitted and are accurately balanced individually, while the complete assemblies of pistons and connecting rods are equalised in weight to within .2 oz. (best aero engine practice). The aluminium pistons are provided with four rings. The side-by-side valves are operated by adjustable tappets actuated by a camshaft of generous diameter driven by duplex roller chain from the crankshaft. The tappets are carried in two guide blocks and can be removed without disturbing any other component. The combustion chambers are completely machined to ensure equality of compression and the minimum of carbon deposits. The induction and exhaust manifolds are cast integral and provided with adequate hot spots. An important feature of the induction system is the combined air preheating and cleaning cover, which also collects and consumes all fumes discharged from the crankcase breather and prevents them entering the car.

**Synchromesh Gearbox.** The easy change gearbox is provided with synchromesh mechanism for top and third gears, which are, in addition, of the constant mesh silent type. The gearbox is provided with an accessible filling orifice and a dipstick level indicator, enabling lubrication attention to be given without disturbing the floorboards.

**Lubrication.** A spur gear pump mounted externally on the side of the crankcase is driven by a diagonal shaft through helical gearing from the camshaft, and supplies oil for a full forced feed oiling circuit. The oil is thoroughly filtered before circulation by a large tray type gauze filter covering the full area of the sump, and is fed under pressure to all main, big-end and camshaft bearings, and also to the clutch. Chassis lubrication is by Enots high-pressure oilgun and accessible oil nipples.

**Cooling System.** The cooling water circulates by thermo-syphon action through large water passages, and leaves the cylinder head through two well-positioned ports which ensure an even distribution of temperature and absence of steam pockets. The radiator is fan assisted.

**Electrical Equipment.** The distributor for the battery and coil ignition is provided with semi-automatic advance and retard control. It is driven from the camshaft by an extension of the oil pump drive spindle. The dynamo is cradle mounted on the side of the cylinder block, belt driven, and easily detachable. It is provided with compensated voltage control which automatically adjusts its output to the requirements of the circuit, and with simple belt adjustment. The starter motor is of the sliding pinion type. Full five-lamp equipment is provided, including headlights with dip and switch mechanism, sidelights, tail-light with automatic stop light. All switches are accessibly mounted on the instrument panel, with the exception of the headlight dipping switch and horn button, which are conveniently situated in the centre of the steering wheel, and the battery master switch which is close to the driver's seat. An easily controlled electric windscreen wiper ensures clear vision in bad weather, and traffic indicators of the concealed type are fitted.

**Carburation.** An S.U. carburettor of the automatic piston type with wide control over mixture strength is fitted. The quality of the mixture and slow running are controlled from the facia board.

**Petrol Tank.** The petrol tank is mounted at the rear of the chassis and has a capacity of  $7\frac{1}{2}$  gallons (34 litres). Its contents are indicated to the driver by an electrically-operated dial gauge on the instrument panel. Fuel is fed to the carburettor by an automatic S.U. electric petrol pump.

**Transmission.** A clutch of the cushioned hub single-plate type with cork inserts in the driven plate, automatically fed with oil from the crankcase, provides smooth engagement with the minimum of attention. A Spicer tubular propeller shaft, with Spicer needle type universal joints at each end, transmits the drive to the silent spiral bevel final reduction gears and differential in the rear axle. The axle shafts are of the three-quarter floating type.

**Four-wheel Brakes.** Fully compensated internal-expanding four-wheel brakes of the Lockheed hydraulic type are operated by the foot pedal. They provide safe and sure braking under all conditions with the minimum of physical effort. They have no bearings to wear or require lubrication. The centrally disposed horizontal hand brake lever operates on the rear wheels by independent mechanism and is provided with instantaneous adjustment from the driver's seat.

**Steering.** The steering gear is of the Bishop cam type, which provides extremely light operation and accuracy of control. The steering gear is commendably free from the transmission of road shocks to the steering wheel. Left-hand drive available on all models.

**Controls.** The accelerator is situated on the extreme right (except on left-hand drive models), and the brake pedal and clutch pedal are positioned to provide ample clearance between the clutch pedal and the gear lever turret.

**Suspension.** Long semi-elliptic springs are fitted front and rear and are controlled by Armstrong hydraulic shock absorbers with improved automatic cold weather regulation.

**Wheels.** Five detachable disc wheels fitted with 6.00—16 Dunlop extra low-pressure cord tyres are provided.

**Tool Kit.** A kit of tools is provided with every car and conveniently housed in a toolbox in the steel dash under the bonnet.

## THE MORRIS FIFTEEN SIX

**General.** The design consists of a six-cylinder water-cooled engine with single-plate cork insert clutch and four-speed synchromesh gearbox built in unit construction. This power unit is carried by a resilient equipoise mounting in a sturdy downsweped frame with generous stiffeners of "X" formation, giving a particularly low centre of gravity. The frame is supported front and rear on long semi-elliptic springs. The track is 4 ft. 4 in. (1.32 m.) and the wheelbase 8 ft. 10 in. (2.69 m.).

**Engine.** The six-cylinder engine has a bore of 63.5 mm. (2.15 in.), a stroke of 102 mm. (4.01 in.) and a cubic capacity of 1938 c.c. (121 cu. in.). Treasury rating 15 h.p. The cylinders are cast in one with the upper portion of the crankcase, which is extended well below the crankshaft centre and liberally reinforced with internal webs, producing a deep girder structure of unusual strength. A four-bearing crankshaft, with the maximum possible bearing areas, is fitted, and all crankshafts are balanced to extremely fine limits. The main and big-end bearings are of the full-ring shim-less type and white-metal lined. The connecting rods are of steel and individually balanced to a high degree of accuracy. The aluminium pistons possess four rings and are closely matched for weight. The complete assemblies of pistons and connecting rods are in addition equalised in weight to within .2 oz. (best aero engine practice). The side-by-side valves are operated by adjustable tappets mounted in two detachable guide units which can be removed without disturbing any other components. The tappets are actuated by a large diameter three-bearing camshaft, driven by a duplex roller chain from the crankshaft, which also drives the dynamo and water pump. The induction pipe and exhaust manifold are an integral casting with adequate hot spots to ensure good carburation. An important feature of the induction system is the combined air cleaner and preheater which also consumes all engine fumes from the crankcase breathers and prevents any undesirable gases entering the car.

**Synchromesh Gearbox.** The gearbox is provided with synchromesh mechanism with interceptor for top and third gears, which are, in addition, of the constant mesh silent type. Gear selection is by centrally disposed lever. The gearbox is provided with an accessible filling orifice and a dipstick level indicator, enabling lubrication attention to be given without disturbing the floorboards.

**Lubrication.** A spur gear pump submerged in the oil sump and driven from the camshaft by helical gearing supplies the oil for the full forced feed oiling circuit. The oil is thoroughly filtered before circulation by a large tray type gauze filter covering the whole area of the sump. The oil is pressure fed to the main and big-end bearings and to the camshaft bearings. A pressure oil feed is also provided to the clutch and timing chain. Chassis lubrication is by Enots high-pressure oilgun and accessible nipples.

**Cooling System.** A centrifugal water pump is mounted in tandem with the dynamo. The water circulates to the cylinder head, where it passes through three well-positioned ports into the outlet pipe. The cooling water is constantly maintained at the most effective temperature by thermostatic control. A generous belt-driven fan also assists the radiator.

**Electrical Equipment.** The distributor for the coil and battery ignition is driven by helical gears from the rear end of the dynamo and possesses semi-automatic advance and retard control. The dynamo is provided with compensated voltage control which automatically adjusts its output to the requirements of the circuit, and it may be removed without disturbing the driving chain. The starter motor is of the sliding pinion type. Full five-lamp equipment is provided, including headlamps with dip and switch mechanism, sidelamps and tail-lamp with stop light. All switches are accessibly mounted on the instrument panel, with the exception of the headlight dipping switch and horn button, which are conveniently mounted in the centre of the steering wheel, and the battery master switch which is close to the driver's seat. Traffic indicators of the concealed type are fitted.

**Carburation.** An S.U. automatic piston type carburettor, with controls for mixture strength and slow running operated from the facia board, supplies the working mixture.

**Transmission.** The single-plate clutch has cork inserts in the driven plate, which has a cushioned hub, and is automatically fed with oil from the engine. A balanced tubular Spicer propeller shaft with Spicer needle type universal joints at each end transmits the drive to the silent spiral bevel final reduction gears and differential. The axle shafts are of the three-quarter floating type.

**Four-wheel Brakes.** The foot brake operates internally-expanding shoes on all four wheels by the Lockheed hydraulic system, which ensures complete compensation and certain braking under all conditions. There are no bearings to wear or need lubrication. The centrally disposed horizontal hand brake lever operates on the rear wheels by independent mechanism, and is provided with instantaneous adjustment from the driver's seat.

**Petrol Tank.** The petrol tank is mounted at the rear of the chassis and has a capacity of 10 gallons (45 litres). Its contents are indicated to the driver by an electrically-operated dial gauge on the instrument panel. The petrol is fed to the carburettor by an S.U. automatic electric petrol pump.

**Steering.** The steering gear is of the Bishop cam type and combines exceptional lightness of steering with accuracy of control. The steering is particularly free from the transmission of road shocks to the steering wheel. Left-hand drive available on all models.

**Controls.** The accelerator pedal is situated at the extreme right (except on left-hand drive models), and ample room is provided between the clutch pedal and the gear lever turret.

**Suspension.** Long semi-elliptic springs front and rear, effectively controlled by Armstrong hydraulic shock absorbers with improved automatic cold weather regulation, provide particularly comfortable suspension.

**Wheels.** Five detachable disc type wheels with 6.00—16 Dunlop extra low-pressure cord tyres are provided.

**Tool Kit.** A kit of tools is supplied with every car and conveniently housed in a toolbox in the steel dash under the bonnet.

# THE MORRIS OXFORD TWENTY

**General.** The design consists of a six-cylinder water-cooled engine with a cork-insert single-plate clutch with Bendix automatic control and a synchromesh four-speed gearbox with free wheel built in unit construction. This power unit is mounted in a frame of improved design, to which are attached, by long semi-elliptic springs fore and aft, axles providing a wheelbase of 9 ft. 6 in. (2.896 m.) and a track of 4 ft. 8 in. (1.422 m.).

**Engine.** The six-cylinder engine has a bore of 73 mm. (2.87 in.), a stroke of 102 mm. (4.01 in.) and a cubic capacity of 2561 c.c. (156.28 cu. in.), with a Treasury rating of 20 h.p. The cylinders are cast en bloc with the skirt of the crankcase, which is extended well below the crankshaft centre and liberally reinforced with internal webs, producing a deep girder structure of tremendous strength. The crankshaft is of the four-bearing type, with bearings of the largest possible dimensions. Every crankshaft is balanced both statically and dynamically to very fine limits. The main bearings and big-end bearings are of the full-ring shim-less type. The steel connecting rods and four-ring aluminium pistons are individually balanced, and the complete assemblies of rods and pistons are equalised in weight to within .2 oz. (best aero engine practice). Side-by-side valves are fitted and operate in combustion spaces that are completely machined to ensure equality of compression and reduction of carbon deposits. The valves are operated by a camshaft of large diameter running in four generous bearings and driven by a duplex roller chain from the crankshaft, which also serves to drive the dynamo. The tappet guides are mounted in three units which can be removed completely without interfering with any other component. The induction pipe and exhaust manifold are cast integral and provided with adequate hot spots. An important feature of the induction system is the combined air preheater cover and cleaner, which also collects and consumes all fumes discharged from the crankcase breathers.

**The Synchromesh Gearbox and Free Wheel.** The four-speed gearbox is provided with synchromesh mechanism with interceptor for the selection of top and third gears, which are of the constant mesh silent type. Gear selection is by centrally disposed lever. Gear changing is rendered completely simple by the addition of a free wheel device which can be locked when desired by a control on the fascia board.

**The Bendix Automatic Clutch Control.** This device reduces driving to an operation of the utmost simplicity. It enables all driving to be carried out by simple actuation of the accelerator pedal without touching the clutch pedal, and in conjunction with the free wheel renders gear changing absolutely quiet and foolproof. When desired it can immediately be placed out of action and the car is then driven in the normal way.

**Lubrication.** A spur gear pump mounted externally on the side of the crankcase and driven from the camshaft by a diagonal shaft supplies oil for a full forced feed oiling circuit. The oil passes through a large and efficient filter covering the greater part of the sump before entering into circulation and is also filtered by a large external filter after passing the pump. Chassis lubrication is effected by an Enots high-pressure oilgun and accessible nipples.

**Cooling System.** A centrifugal pump driven from the rear of the fan spindle circulates the cooling water. It is passed from the cylinder head through three carefully positioned ports which ensure even temperature distribution. The water is maintained at the most effective temperature by thermostatic control and the radiator is fan assisted.

**Electrical Equipment.** The distributor for the coil and battery ignition is driven from the upper end of the diagonal oil pump drive. It is provided with fully-automatic advance and retard control. The dynamo is readily detachable without disturbing the timing chain and is provided with compensated voltage control which automatically adjusts its output to the requirements of the circuit. The starter motor is of the sliding pinion type. Full five-lamp equipment is provided, including dipping headlights, sidelights, fog lamp, automatic stop and reverse lights. The lighting switch together with the Trafficator switch and horn push are mounted in the centre of the steering wheel. Included is an electric windscreen wiper with twin blades, concealed traffic indicators with automatic release switch, and battery master switch.

**Carburation.** An S.U. carburetter, with automatic thermostatic control over mixture strength, supplies the working mixture.

**Petrol Tank.** The petrol tank is mounted at the rear of the chassis and has a capacity of 14 gallons (63½ litres). Its contents are indicated to the driver by an electrically-operated dial gauge on the instrument panel. The petrol feed to the carburetter is provided by an S.U. automatic electric petrol pump.

**Transmission.** A clutch of the cushioned hub single-plate type having cork inserts in the driven plate, automatically fed with oil from the crankcase, ensures smoothness of action, and requires the minimum of attention. A balanced tubular propeller shaft with Spicer needle type universal joints at each end transmits the drive to the spiral bevel final drive gears and differential in the rear axle. The axle shafts are of the three-quarter floating type.

**Four-wheel Brakes.** Fully compensated four-wheel brakes of the Lockheed hydraulic type ensure the maximum of braking efficiency. Their certainty and efficiency of action is maintained under all conditions, since lost motion or loss of leverage, due to wear, is entirely eliminated. The brakes have steel shoes operating in special cast drums and are silent in action. The centrally disposed horizontal hand brake lever operates on the rear wheels through independent mechanism, and is provided with instantaneous adjustment from the driver's seat.

**Steering.** The steering gear is of the Bishop cam type, providing extremely light and safe operation. Left-hand drive is available on all models.

**Controls.** The accelerator pedal is situated at the extreme right (except on left-hand drive models), and ample room is provided between the clutch pedal and the gear lever turret.

**Suspension.** The long semi-elliptic springs front and rear are effectively controlled by shock absorbers of the Luvax double-acting hydraulic type.

**Wheels.** Five detachable Magna type wire wheels with 7.00—16 Dunlop extra low-pressure cord tyres are fitted.

**Tool Kit.** A kit of tools is provided with every car. These are housed in an accessible toolbox.



# Morris Chassis ....

**F**OR the convenience of those who wish to have their cars fitted with special coachwork to suit their individual requirements, Morris chassis are obtainable separately. These chassis are exceptionally well equipped and include such items as wings, running-boards, headlamps, instruments, spare wheel and complete tool kit; in short, they are all ready for the coachwork.

## **MORRIS EIGHT CHASSIS**

General specification as on page 26. The chassis equipment includes: Dash, scuttle frame front member with bonnet rest fitted, splashers, pedal rubbers, headlamps, sidelamps, dimming switch, tail-lamp, battery, front and rear wings (enamelled), bonnet ledge, front and rear number-plates, speedometer, oil gauge, electric petrol gauge, ammeter, electric horn, kit of tools, spare wheel and tyre, hydraulic shock absorbers front and rear, bumpers front and rear, bonnet fitted to chassis complete with fasteners, running-boards covered.

## **MORRIS TEN CHASSIS**

General specifications as on page 27. The chassis equipment includes: Steel dash, scuttle rim, clock, speedometer, electric petrol gauge, splashers, pedal rubbers, front wings, stays and rear wings (enamelled), headlamps with dipping mechanism, sidelamps, rear lamp with stop light, batteries, front and rear bumpers, front and rear number-plates, oil gauge, ammeter, electric horn, kit of tools, spare wheel and tyre, calorimeter with wings, hydraulic shock absorbers front and rear, bonnet fitted to chassis complete with fasteners, running-boards covered and beaded.

## **MORRIS TWELVE FOUR CHASSIS**

General chassis specification as on page 28. The chassis equipment includes: Steel dash, scuttle rim, clock, speedometer, electric petrol gauge, splashers, pedal rubbers, front wings, stays and rear wings (enamelled), headlamps with dipping mechanism, sidelamps, rear lamp with stop lamp, batteries, front

and rear bumpers, front and rear number-plates, oil gauge, ammeter, electric horn, kit of tools, spare wheel and tyre, calorimeter with wings, hydraulic shock absorbers front and rear, bonnet fitted to chassis complete with fasteners, running-boards covered and beaded.

## **MORRIS FIFTEEN SIX CHASSIS**

General chassis specification as on page 29. The chassis equipment includes: Steel dash, scuttle rim, clock, speedometer, electric petrol gauge, splashers, pedal rubbers, front wings, stays and rear wings (enamelled), headlamps with dipping mechanism, sidelamps, rear lamp with stop lamp, batteries, front and rear bumpers, front and rear number-plates, oil gauge, ammeter, electric horn, kit of tools, spare wheel and tyre, calorimeter with wings, hydraulic shock absorbers front and rear, bonnet fitted to chassis complete with fasteners, running-boards covered and beaded.

## **MORRIS OXFORD TWENTY CHASSIS**

General specification as on page 30. The chassis equipment includes: Steel dash, scuttle frame front member with rubber bonnet rest fitted, dumb-iron masks, splashers, clutch and brake pedal rubbers, clock, speedometer, dash-reading electric petrol gauge, rear lamp with stop and reverse light, headlamps with dipping mechanism, sidelamps, battery, front wings, stays and rear wings (enamelled), front and rear bumpers, front and rear number-plates, oil gauge, ammeter, electric horn, full kit of tools, spare wheel and tyre, calorimeter with wings, hydraulic shock absorbers front and rear, bonnet fitted to chassis complete with fasteners, running-boards covered and beaded.

*Purchasers of Morris chassis are requested carefully to note paragraph 3(f) of Guarantee. No variation in the above chassis specifications can be made.*



## GUARANTEE

1. For a period of SIX MONTHS from the date on which a new Morris Vehicle or Chassis is delivered to the first owner-user thereof Morris Industries Exports Limited will exchange or repair any part or parts thereof which needs or need replacement or repair by reason of defective workmanship or defective material. The Company will not be responsible for any expense which the purchaser may incur in removing or having removed or in replacing or having replaced any part or parts to be sent for inspection or in fitting or having fitted any new parts supplied in lieu thereof.
2. No claim for exchange or repair can be considered hereunder unless the person claiming
  - (a) Returns the part or parts complained of to the Company's authorised Distributor in the Territory in which the Car or Chassis was purchased carriage paid.
  - (b) Sends therewith particulars of the chassis number and engine number of the Car or Chassis in question, as shown on the manufacturer's identification plate.
  - (c) Sends also particulars stating the date of the purchase and the name and address of the person or firm from whom the Car or Chassis was purchased.
  - (d) Refers to this Guarantee.
3. This Guarantee shall not apply to
  - (a) Any accessories or proprietary fittings whatsoever.
  - (b) Any Car or Chassis used
    - (i) As a Hackney Carriage.
    - (ii) For hiring out.
    - (iii) For any purpose other than the private or genuine commercial use of the owner-user.
  - (c) Any defective part or parts which in the opinion of Morris Industries Exports Limited has or have been injured by wear and tear or by any form whatsoever of improper use of or from any alteration whatsoever to the Car or Chassis.
  - (d) Any second-hand Car or part or parts thereof.
  - (e) Anything whatsoever not manufactured by Morris Motors Limited and sold by the Company.
  - (f) Any part or parts of a Chassis to which a body which in the opinion of the Company is unsuitable has been fitted.
  - (g) Any vehicle in or to which any part not sold by Morris Industries Exports Limited has been affixed.
4. The liability of Morris Industries Exports Limited is limited to exchange or repair under Clause 1 hereof. Every form of liability for every form of consequential loss or damage is hereby expressly excluded.
5. This Guarantee is given in lieu of and excludes every condition or warranty, whether statutory or otherwise, whatsoever not herein expressly set out.

# PRINCIPAL DIMENSIONS OF MORRIS CARS

Season 1935

Fifteen Six Saloon (F.H.)	Fifteen Six Saloon (S.H.)	Fifteen Six Special Coupé	Oxford Saloon	Oxford Special Coupé
in. 25 $\frac{3}{8}$	in. 25 $\frac{3}{8}$	in. 37 $\frac{1}{4}$	in. 30 $\frac{3}{8}$	in. 37 $\frac{1}{4}$
25 $\frac{3}{8}$	25 $\frac{3}{8}$	—	27 $\frac{1}{4}$	—
46	45	44	45	44
39	39	37	38	37
37	37	36	39	36
47	47	47	49	49
55	55	49	55	49
42 $\frac{1}{2}$	42 $\frac{1}{2}$	42	43	42
11	11	11	12	11
14	14	12	12	10
20	20	19	20	19
22	22	18	21	17
49	49	49	52	50
39	39	41	45	42
45	45	38	45	38
40	40	31	38	31
—	19	20 $\frac{1}{2}$	21	21 $\frac{1}{2}$
—	35 $\frac{1}{2}$	35 $\frac{1}{2}$	36	37 $\frac{1}{2}$
—	—	37	—	37
—	—	5	—	5
—	—	15 $\frac{1}{2}$	—	15 $\frac{1}{2}$
—	—	4	—	4
—	—	15 $\frac{1}{2}$	—	15 $\frac{1}{2}$
16	16	21	16	21
35 $\frac{1}{2}$	35 $\frac{1}{2}$	37	31	37
67	67	65	68	67
160	160	163	173	176
171	171	176	184	186
65 $\frac{1}{2}$	65 $\frac{1}{2}$	65 $\frac{1}{2}$	70	70
106	106	106	114 $\frac{3}{4}$	114 $\frac{3}{4}$

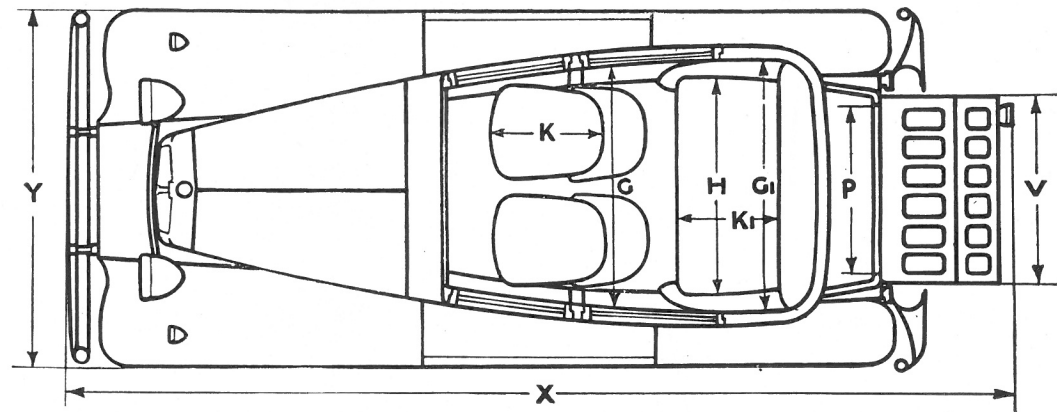
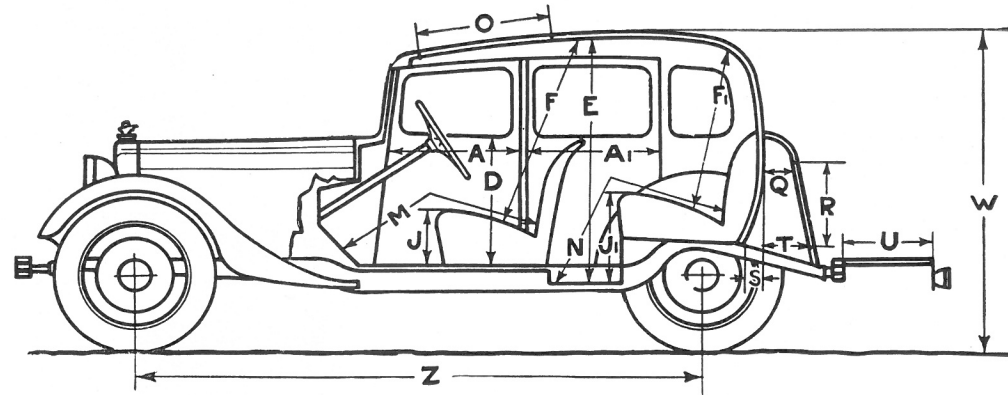

# MORRIS 1935 COA

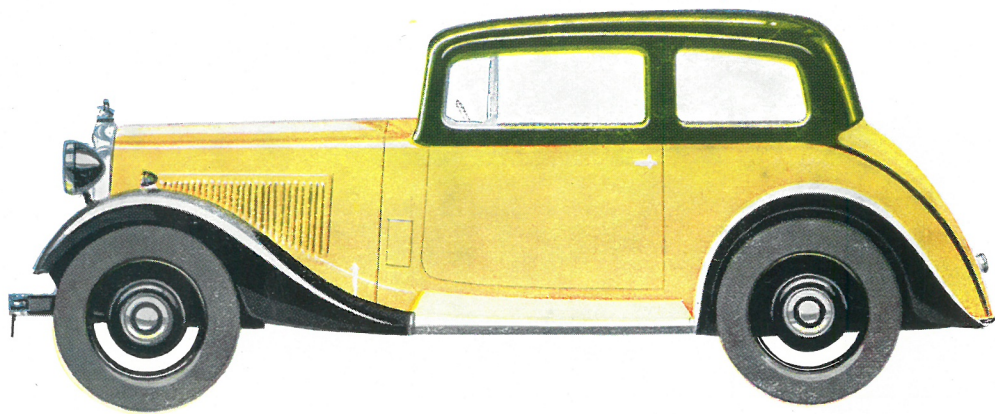

**CREAM/GREEN CELLULOSE** obtainable on :

Ten Four Special Coupé  
Ten Six Special Coupé  
Fifteen Six Special Coupé  
Oxford Special Coupé

**GREEN DUOTONE CELLULOSE** obtainable on :

Ten Four Special Coupé  
Ten Six Special Coupé  
Fifteen Six Special Coupé  
Oxford Special Coupé

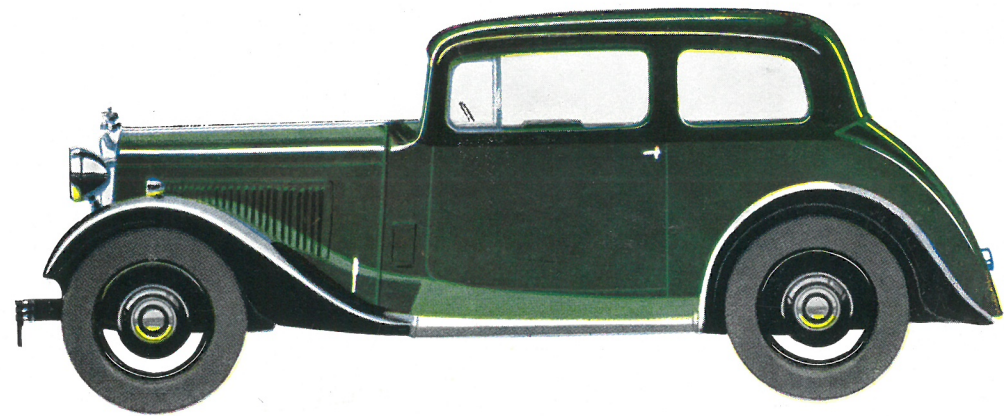

**BROWN DUOTONE CELLULOSE** obtainable on :

Ten Four Special Coupé  
Ten Six Special Coupé  
Fifteen Six Special Coupé  
Oxford Special Coupé

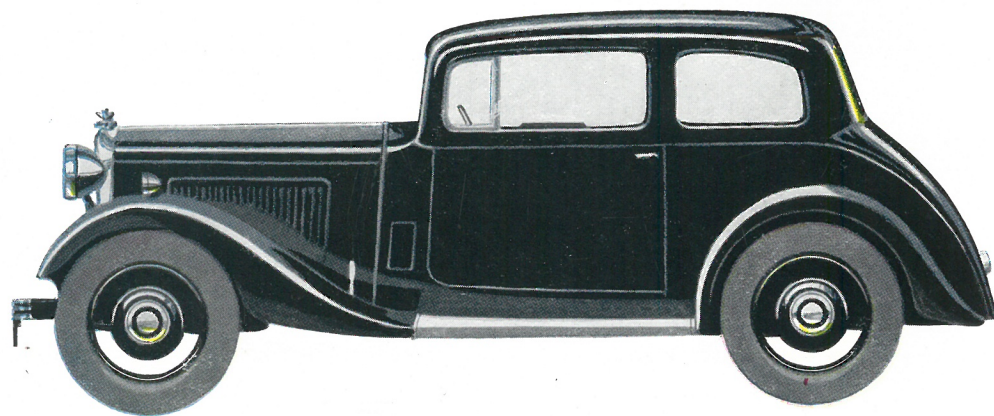

**ALL BLACK CELLULOSE** obtainable on :

All models except the  
Eight 2-Door Saloon (Sliding Head) and  
Eight 4-Door Saloon (Sliding Head)

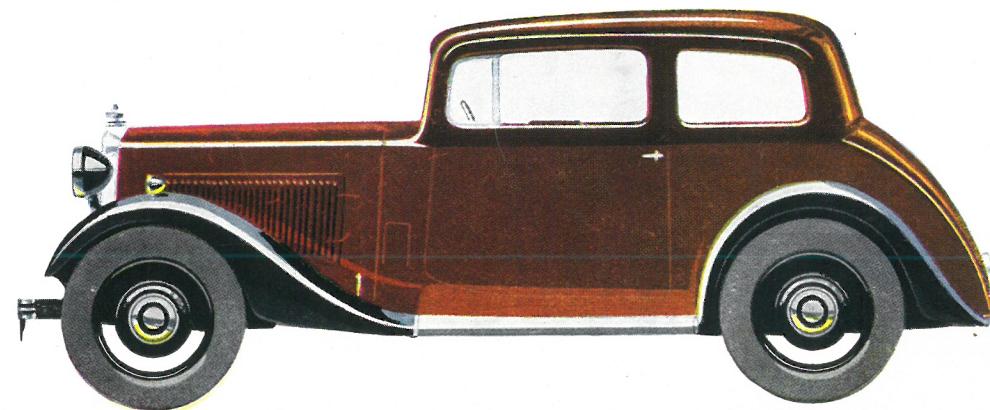

# PAINTWORK COLOURS

## RED/BLACK CELLULOSE obtainable on :

Eight 2-Door Saloon  
Eight 4-Door Saloon  
Ten Four Saloon  
Ten Six Saloon  
Twelve Four Saloon  
Fifteen Six Saloon  
Oxford Saloon

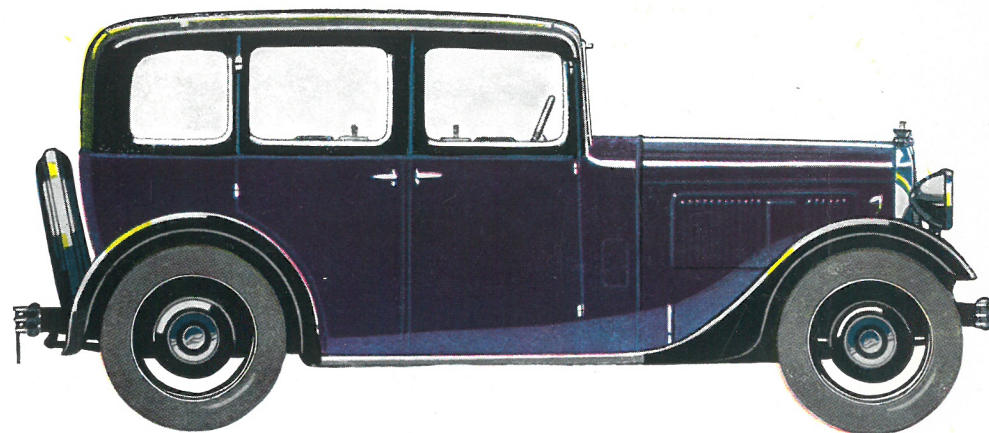
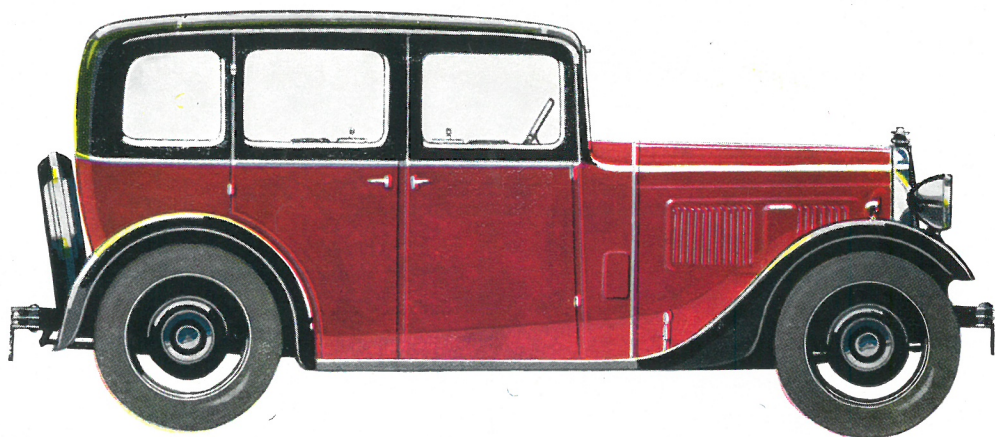

## BLUE/BLACK CELLULOSE obtainable on :

Eight 2-Door Saloon (Sliding Head models only)  
Eight 4-Door Saloon (Sliding Head models only)  
Oxford Saloon

## GREEN/BLACK CELLULOSE obtainable on :

Eight 2-Door Saloon (Sliding Head models only)  
Eight 4-Door Saloon (Sliding Head models only)  
Ten Four Saloon  
Ten Six Saloon  
Twelve Four Saloon  
Fifteen Six Saloon  
Oxford Saloon

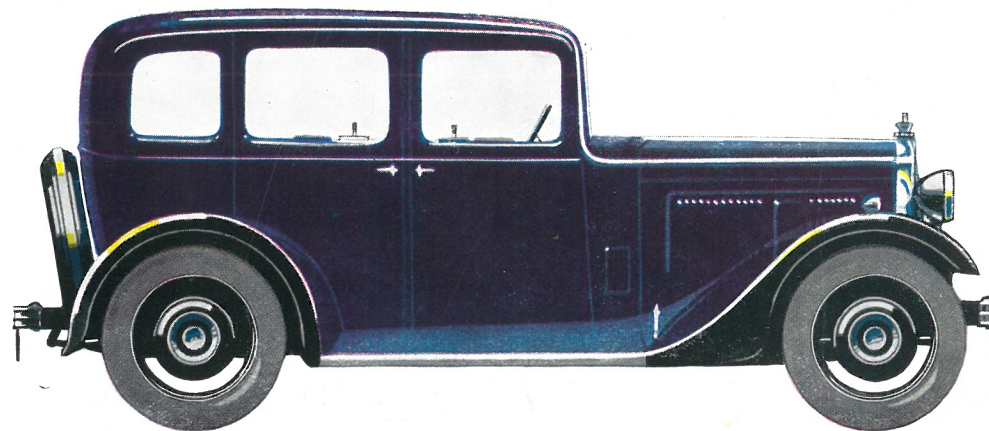
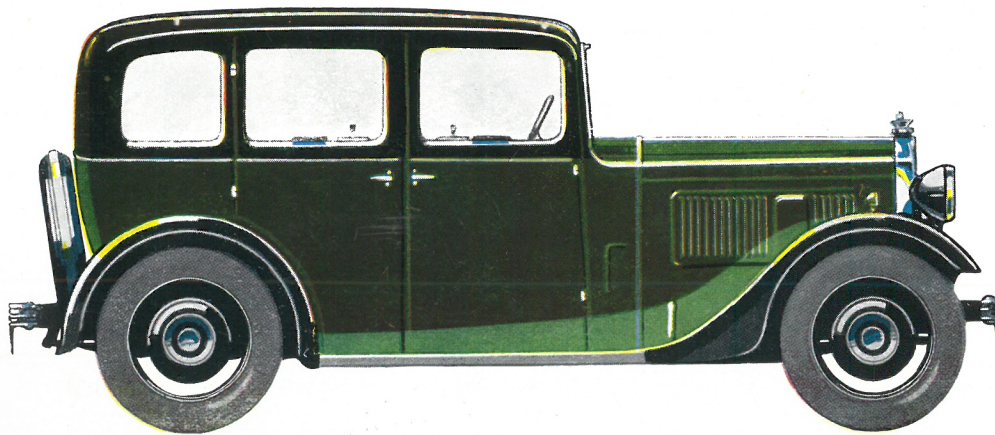

## ALL BLUE CELLULOSE obtainable on :

Ten Four Saloon  
Ten Six Saloon  
Twelve Four Saloon  
Fifteen Six Saloon

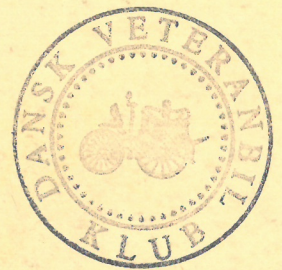
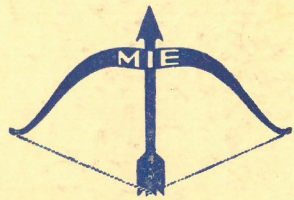

PRINTED IN GREAT  
BRITAIN BY THE  
MORRIS-OXFORD  
PRESS LIMITED  
COWLEY - OXFORD  
ENGLAND

26449-10/34/3011

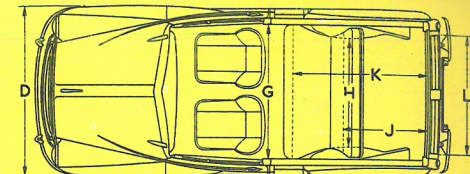
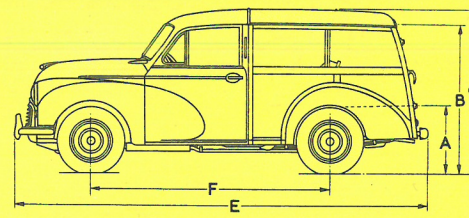
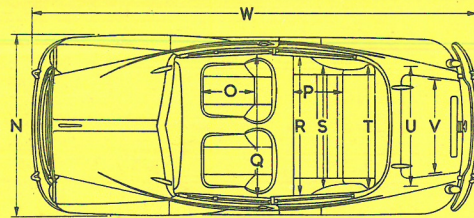
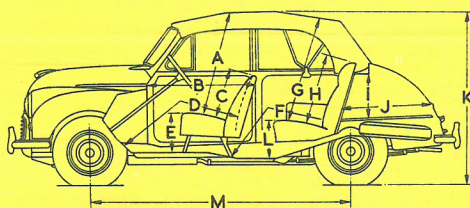

## DIMENSIONER

### MORRIS 1000

<b>A</b> 96 cm	<b>B</b> 2-dørs 84 cm	<b>B</b> 4-dørs 71 cm	<b>I</b> 35 cm	<b>J</b> 74 cm	<b>K</b> 152 cm	<b>R</b> 118 cm	<b>S</b> 104 cm	<b>T</b> 112 cm
<b>C</b> 48 cm	<b>D</b> 112/119 cm	<b>E</b> 32 cm	<b>L</b> 33 cm	<b>M</b> 218 cm	<b>N</b> 155 cm	<b>U</b> 96 cm	<b>V</b> 79 cm	<b>W</b> 376 cm
<b>F</b> 104/112 cm	<b>G</b> 94 cm	<b>H</b> 58 cm	<b>O</b> 48 cm	<b>P</b> 46 cm	<b>Q</b> 123 cm	Bagdørenes bredde på 4-dørs modellen er 71 cm. Sporvidde: for 1,284 m, bag 1,278 m		

### STATION CAR/COMBI

<b>A</b> 67 cm	<b>B</b> 141 cm	<b>C</b> 154 cm	<b>G</b> 118 cm	<b>H</b> 99 cm	<b>J**</b> 79 cm
<b>D</b> 155 cm	<b>E</b> 378 cm	<b>F</b> 218 cm	<b>K*</b> 127 cm	<b>L</b> 104 cm	

\* I gulvhøjde med bagsædet opslået til persontransport.

\*\* I gulvhøjde med bagsædet sammenfoldet til varetransport.

### KØREKLAR VÆGT:

2-dørs saloon . . . . .	750 kg
4-dørs saloon . . . . .	775 kg
Cabriolet . . . . .	737 kg
Station car . . . . .	800 kg

## SPECIFIKATIONER:

### MORRIS 1000

**MOTOR:** 4-cylindret, topventilet med stødsænger og vippearme. Boring 63 mm, slaglængde 76 mm, cylindervolumen 948 cm<sup>3</sup>. Krumtappen har 3 hovedlejer, der er udskiftelige lejeskåle af stål med belægning af hvidtmetal, plejlstanglejerne er udstyret med udskiftelige foringer af stål med blyindium belægning. Kompressionsforhold: 8,3:1. Den højkomprimerede motor udvikler 38 HK ved 4.800 omdrejninger pr. min. Stempler af aluminiumslegering. Udvendigt gennemstrømningsoliefilter med udskifteligt element.

**KØLESYSTEM:** Trækkølesystem med ventilator og vandpumpe. Vandcirkulationen reguleres af en termostat.

**TÆNDINGSSYSTEM:** Automatisk tændingsregulering, der styres mekanisk og ved vakuum.

**BRÆNDSTOFSYSTEM:** Automatisk S.U. karburator, der gennem en elektrisk S.U. benzinpumpe tilføres benzin fra tanken, der er anbragt bag til og rummer 29,6 liter.

**KOBLING, GEARKASSE OG BAGAKSEL:** Borg & Beck tør enkeltplade kobling med særdeles blød og behagelig funktion. 4-trins gearkasse med synchromeshanordning for andet, tredje og fjerde gear. Samlede udvekslingsforhold: 1. gear 16,47, 2. gear 10,80, 3. gear 6,415, 4. gear 4,55, baggear: 21,20. Kort, stiv gearstang, anbragt bekvemt tilbagerykket, hvor hånden naturligt vil finde den. Kardanakslen er af Hardy Spicer typen med nålelejer i leddene og glidemuffe. Bagakslen er trekvart-flydende og har kron- og spidshjul af hypoid typen.

**BREMSE:** Lockheed fuldtudlignende 4-hjuls bremses. Enkel justering af bremseskoene, hvorved håndbremsen samtidig indstilles.

**KAROSSERI:** Det monokonstruerede karrosseri omfatter sider, tag, gulv, forbræt, bundvanger og sideplader til hjulkasser. Kofangere, der er i eet stykke, for og bag, dækker hele vognens bredde.

**AFFJEDRING:** Uafhængig forhjulsaffjedring med lange torsionsstænger. Lange styrebolte. Hydrauliske støddæmpere af stømpeltypen, hvis arm udgør den øverste forhjulsarm. Anordning til finindstilling af torsionsstængerne. Halvelliptiske bagfjedre, der er ophængt i gummi, og hydrauliske støddæmpere af stømpeltypen.

**HJUL OG DÆK:** Stålpladehjul med fire navbolte. Slangeløse dæk, størrelse 5.00X14. Reservehjulet er anbragt i et særskilt rum under bagagerummet.

**STYRETØJ:** Skålformet sikkerhedsrat. Tandstangsstyretøj med direkte forbindelse til armene på styreboltene. Vognene leveres venstrestyrede i Danmark.

**ELEKTRISK Udstyr:** Dynamo med automatisk spændingsregulering. 12-volts batteri. Forlygter med asymmetrisk lys. Kontrollampe for langt lys. Nedblændingskontakt til betjening med foden. Særskilte parkeringslygter. To stop- og baglygter med refleksglas. Nummerpladebelysning og instrumentbelysning. Dobbelt, elektrisk, selvparkerende vindspejlsvisker med kraftig motor, der er gummiophængt i motorrummet, så støj undgås. Elektrisk windtone horn. Blinklys med automatisk kontakt. Tændingskontrollampe. Automatisk loftbelysning.

**INSTRUMENTER:** Speedometer, benzinur, ladekontrollampe og kontrollamper for olietryk, blinklys og langt lys. Instrumentbrættet omfatter endvidere tændingskontakt, chokerknop, startkontakt, lyskontakt og kontakt til vindspejlsviskerne.

**ØVRIGE Udstyr:** Triplex sikkerhedsglas overalt. Stort, buet vindspejl i ét stykke. Vynide betræk på sæderne og 2 lag tykke måtter på gulvet. Askebæger ved bagsædet. Orienteringsspejl. Trækfri ventilationsruder i for-dørene. Dørlåsene har glatte håndtag af udtrækstypen. Der er to adskilte forstole, og førerens sæde er let indstilleligt. Der er også mulighed for indstilling af passagersædet. To lukkede handskerum i instrumentbrættet og pakkehynde i hele vognens bredde. Friskluftvarme- og defrosteranlæg. Solskærm på førerens plads. Speciel donkraft til løftning af én vognside ad gangen. Radio kan monteres. Kofangerhorn er ekstraudstyr.

### MORRIS 1000 Station Car

**KARROSSERI OG CHASSIS:** Det specielle karrosseri omfatter forende, bundplader, forbræt, chassisvanger og sidestykker til skærmene, herpå er monteret et rummeligt station car karrosseri. Forende af karrosseri og undervognen er fuldstændig rustbeskyttet. Forreste kofanger er i ét stykke, og bageste kofanger er todelt med plads til nummerplade i midten. To adskilte forstole, der kan vippes fremover, så der er bekvem adgang til bagsædet. Dette har rigelig plads til to personer og kan vippes ned i plan med gulvet, så der bliver stor plads til bagage eller lettere varetransport. Sæderne er beklædt med kunstlæder. Store skydevinduer i siderne. To brede bagdøre, der i åben stilling fastholdes af dørstopperne. Friskluftvarme- og defrosteranlæg. Kofangerhorn er ekstraudstyr.

*Ret til ændringer i specifikationer u. varsel forbeholdes*



Generalrepræsentant for Danmark:

**DANSK OVERSØISK MOTOR INDUSTRI A/S**

**GLOSTRUP**

TLF. 96 14 10 — 96 24 10

AUTORISERET FORHANDLER:

