

THE AUSTIN

A40 - A50 Cambridge

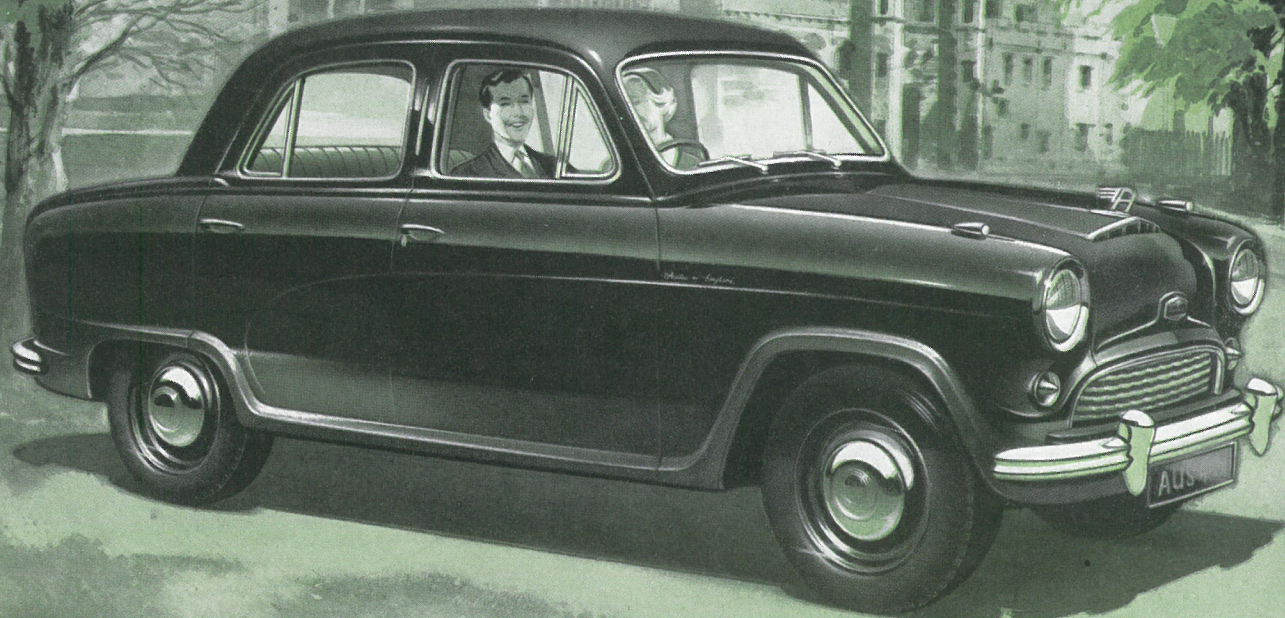

YOU CAN DEPEND ON IT



AUSTIN — YOU CAN DEPEND ON IT

THE AUSTIN A40—A50 CAMBRIDGE



With sales totalling 600,000 in a little over six years, the Austin A40 Devon and Somerset models achieved a world-wide popularity unequalled by any other light car. Now comes the A40—A50 Cambridge, a successor to these two famous cars and indeed the finest of them all.

Already making a name for itself as a car of unlimited scope and versatility the Cambridge embodies a great many features that will whet the appetite of motorists everywhere. It offers comfortable coachwork with a choice of style, colour, trim and equipment, alternative O.H.V. 1200 c.c. or 1500 c.c. engine, new high-efficiency steering, special easy change gear mechanism, large-diameter hydraulic brakes and independent coil spring front suspension. It has everything, in fact, to bring a new delightful quality to inexpensive motoring.

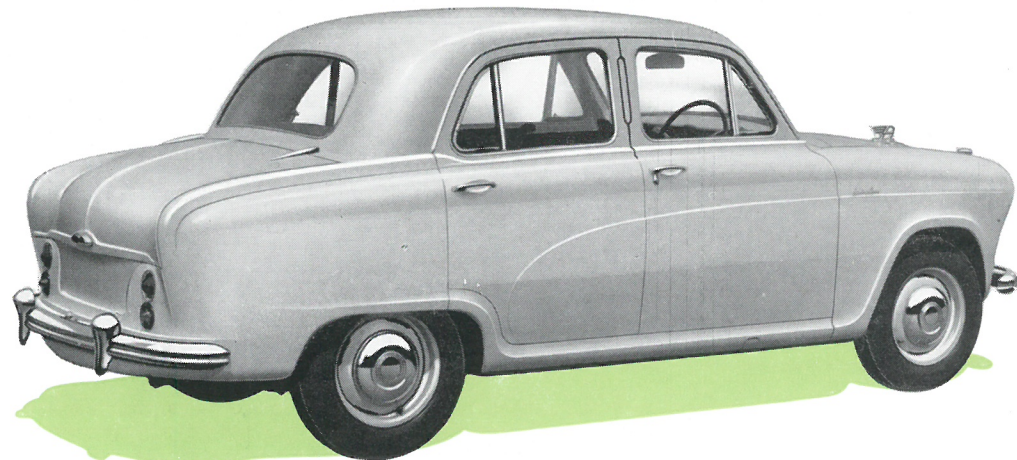

The Cambridge is available in four versions ; 4-door Standard and 4-door De Luxe Saloons with the 1200 c.c. A40 engine : also 4-door Standard and De Luxe Saloons with the 1500 c.c. A50 engine. Thus, there is a Cambridge model to suit all tastes and pockets.

THE FINEST OF THEM ALL

Of all-steel unitary construction the Cambridge body has great torsional strength. It provides safe and comfortable accommodation for four or five passengers and there is a fine choice of exterior colours and interior trim.

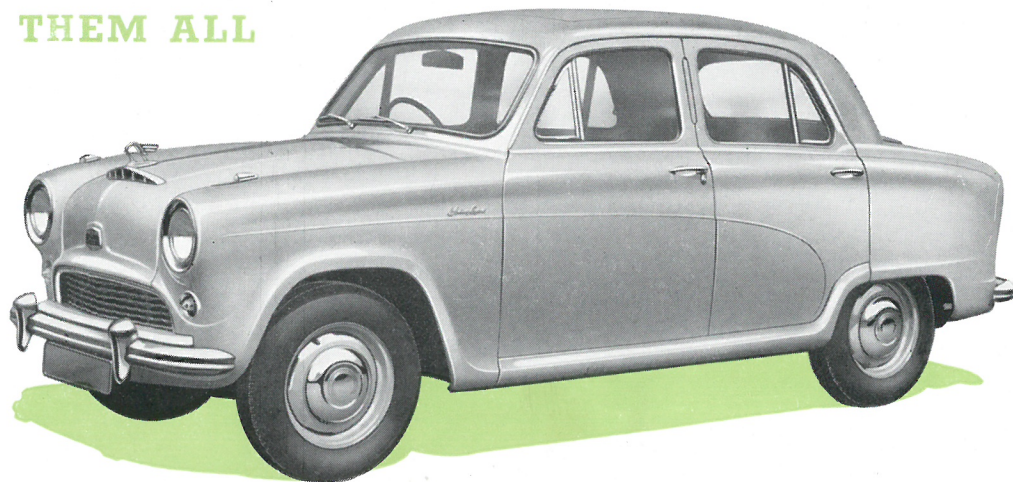

THE FAMOUS A40-A50—

As with all Austin engines, the Cambridge high-performance power units are of compact O.H.V. design. They incorporate many special features in respect of lubrication, cooling, valve operation and silent running, and all components are made and assembled with the utmost precision to give long life and dependability.

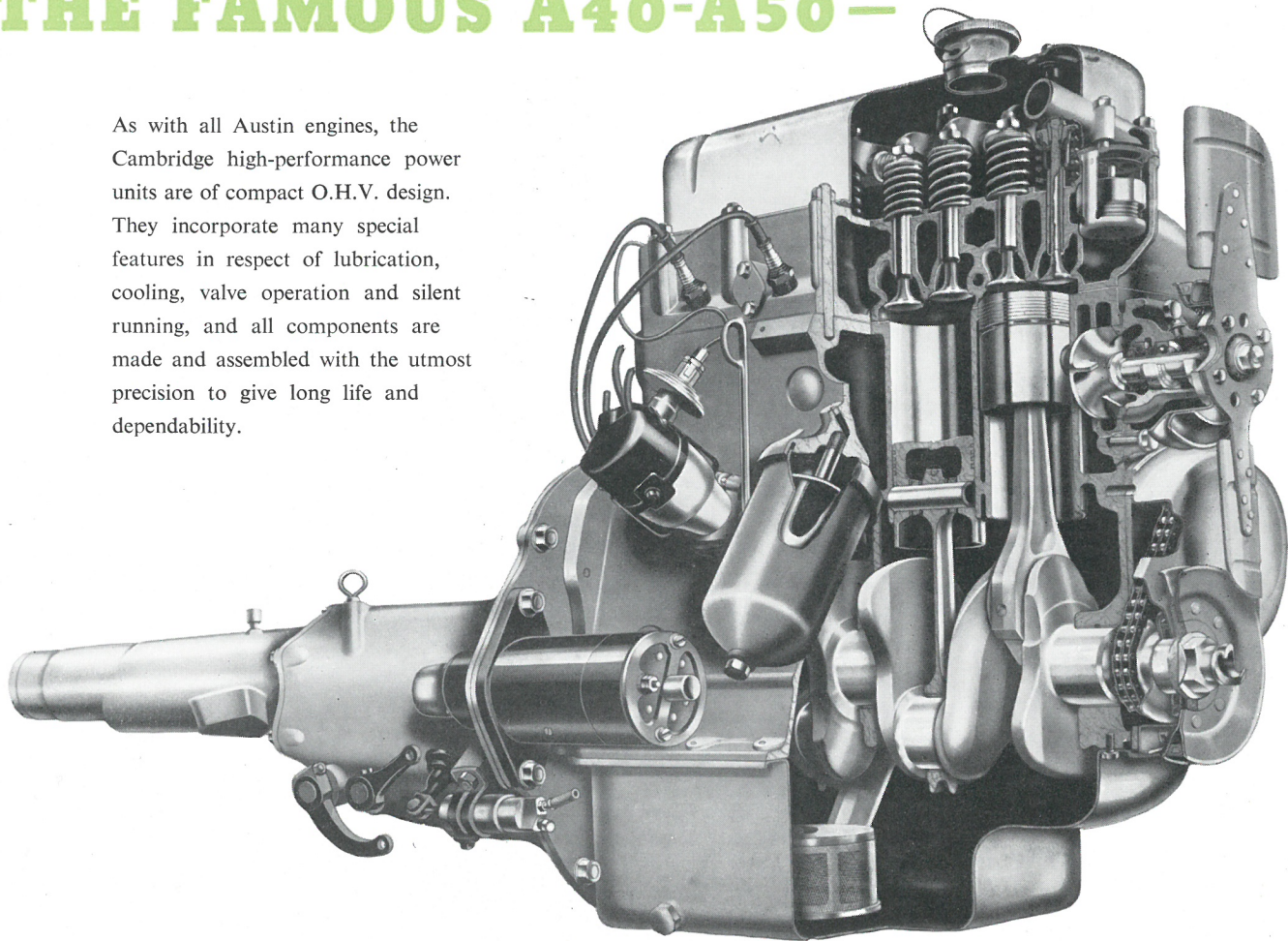

O.H.V. ENGINE

A choice of two power units is provided. The A40 of 1200 c.c. capacity developing 42 b.h.p. at 4,500 r.p.m., and the A50 of 1500 c.c. capacity which develops 47 b.h.p. at 4,100 r.p.m. Both these engines are smoothly powerful and economical to run.

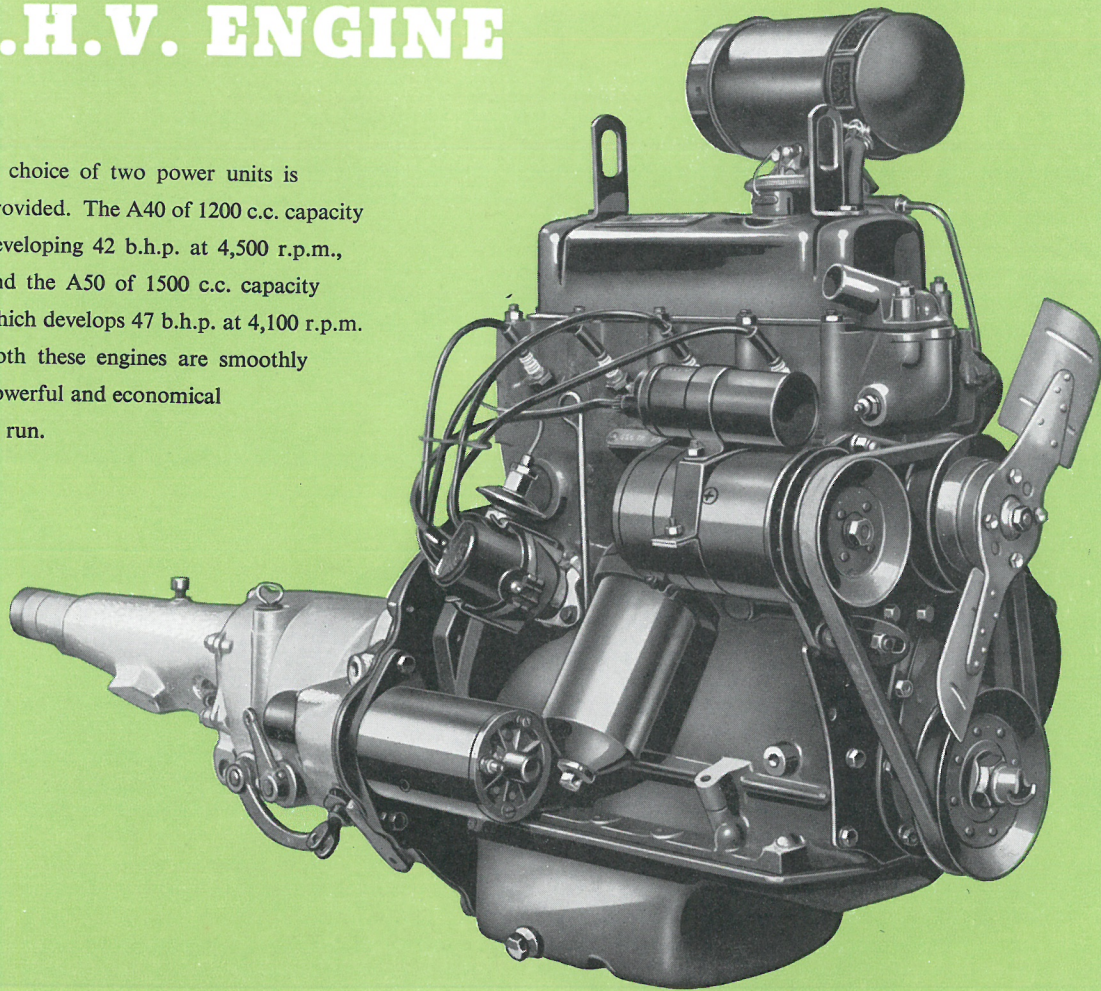

HIGH PERFORMANCE

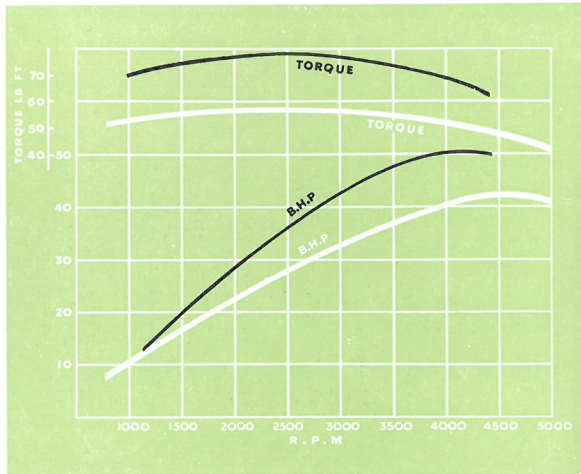
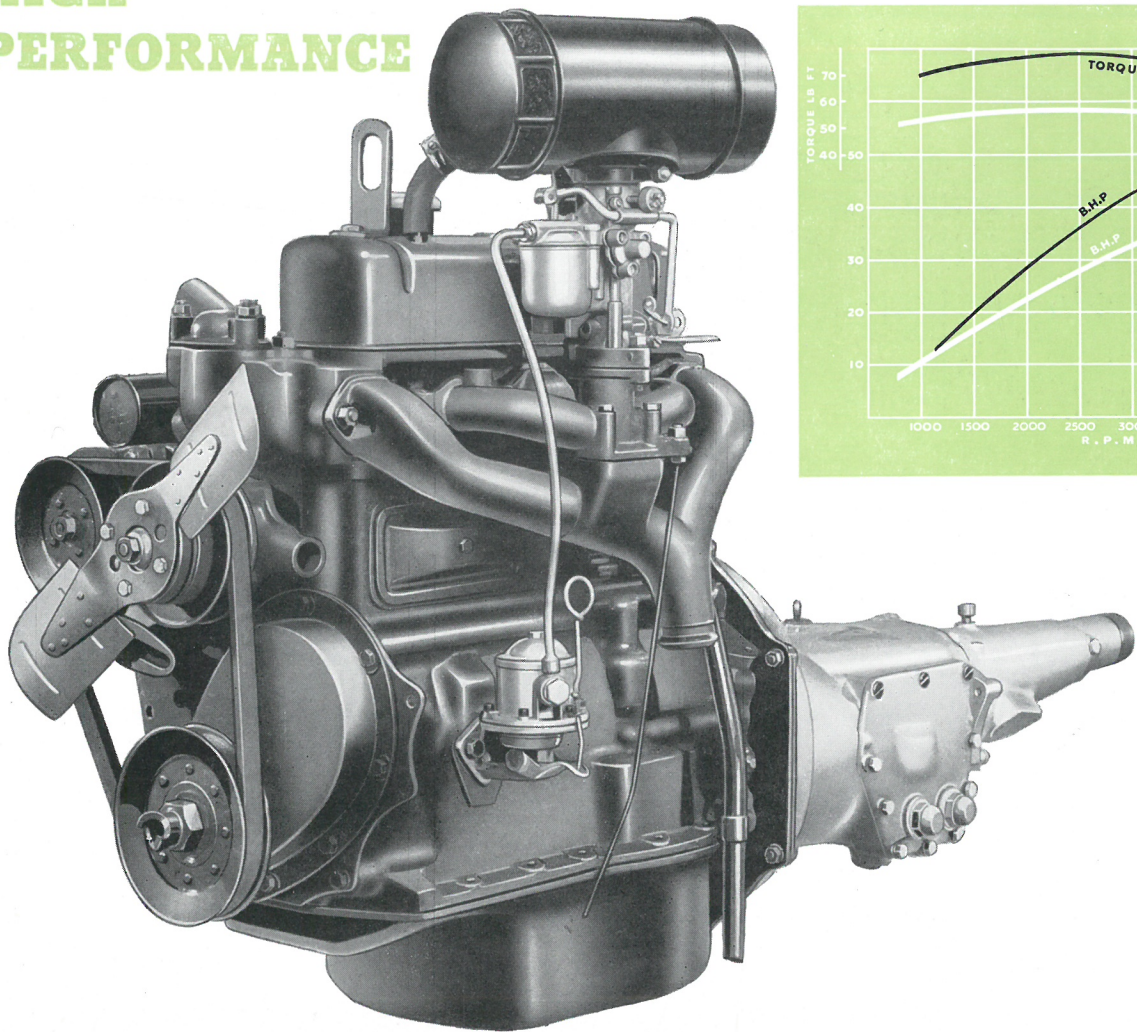

OVERHEAD VALVES

The position of the overhead valves at the top of the engine makes them exceptionally accessible for periodical inspection and adjustment. They are actuated by push-rods from the camshaft and are extremely efficient and silent in operation.

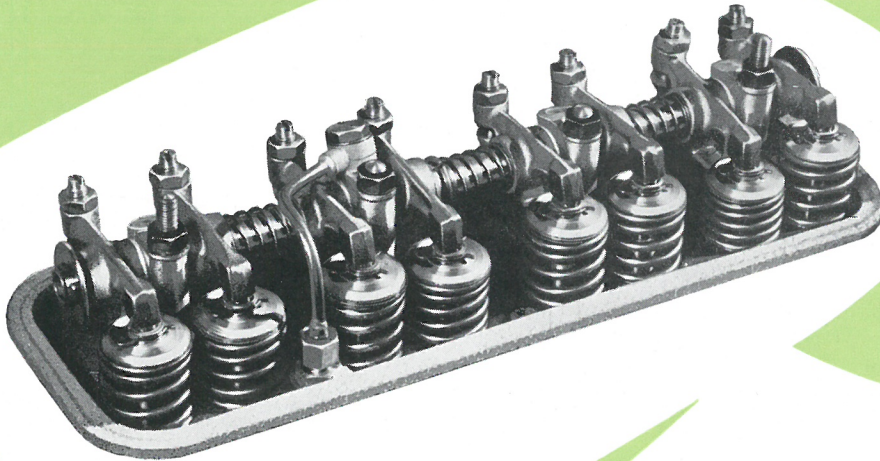

CAST-IRON CRANKCASE

Foundation for dependable power is the tough cast-iron crankcase and cylinder block with its perfectly machined jointing surfaces. Ample water passages incorporated in the block provide for generous cooling of the cylinder bores.

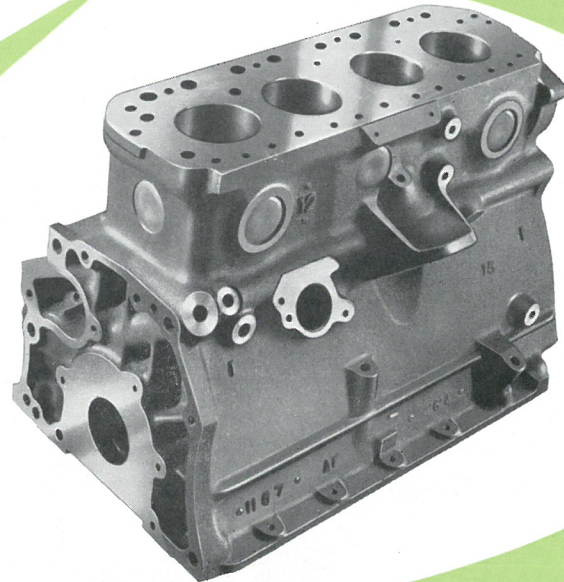

INSIDE INFORMATION

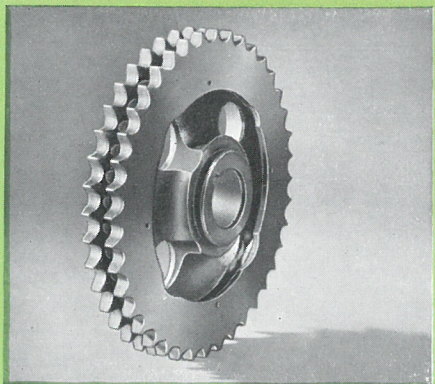

TENSIONER RING

A synthetic rubber ring is fitted between the sprockets of the camshaft gear to maintain timing chain tightness and ensure silent running.



PISTONS

The aluminium alloy pistons are concave-topped to assist even combustion and give vibrationless running. They are fitted with four rings—three compression and one slotted for oil return.



CAMSHAFT

Special Austin patents are embodied in the design of the camshaft to provide the most efficient valve lift and give quiet operation. This component is machined within limits of half a thousandth of an inch.

CRANKSHAFT

Holes drilled in the crankpins of the tough forged steel crankshaft ensure an ample flow of lubricant to the bearings.

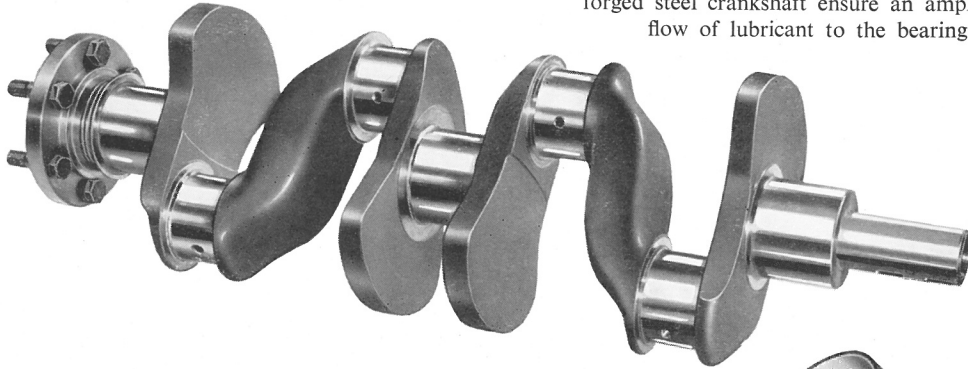

BEARINGS

Main and connecting rod bearings are shell type, steel-backed and lined with white metal.

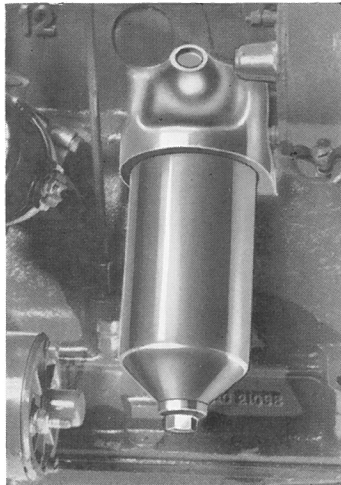

OIL FILTER

A by-pass filter with renewable element is included in the lubrication system. This extracts any harmful foreign matter and allows only clean oil to circulate round the engine.

CONNECTING-RODS

The forged steel connecting rods have jet holes to provide lubrication for the cylinder walls immediately the engine is started. This ensures maximum life for bores and pistons.



ENGINE LUBRICATION

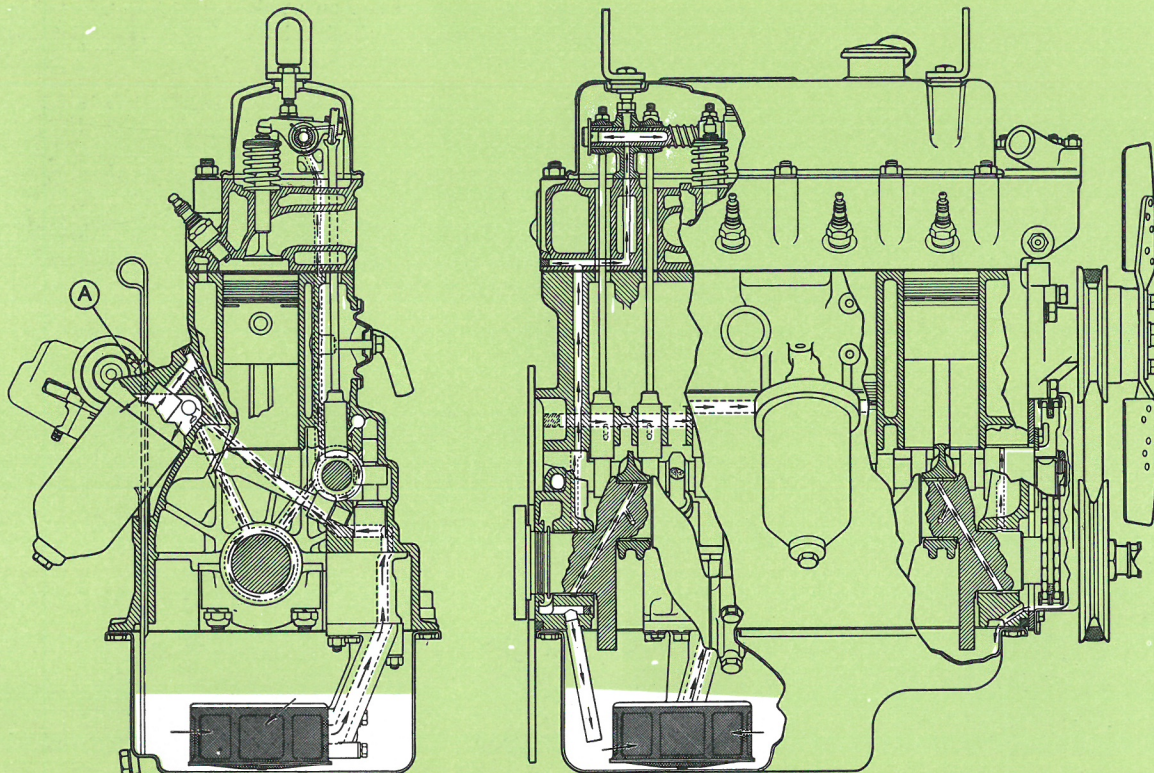

The lubrication system of the Austin Cambridge engine incorporates many patented features. Oil is delivered to an oil gallery on the right-hand side of the crankcase, and thence under pressure to main, connecting rod and camshaft bearings. The front camshaft bearing feeds

oil to the camshaft gear for timing chain lubrication while the camshaft rear bearing supplies lubricant to the overhead valve rocker gear. There is a pressure feed to each tappet, and the oil returns to the sump by way of the push-rod apertures.

THE FUEL SYSTEM

HOT-SPOT

A stainless-steel hot-spot is fitted in the induction system just below the carburetter.

The lower portion of this device diverts some of the hot exhaust gases on to the upper plate which in turn pre-heats the fuel passing over it. This ensures more efficient vaporisation of the fuel in the carburetter.

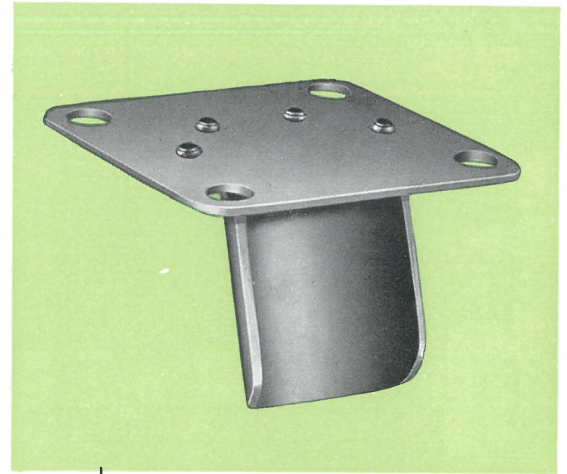

CARBURETTER

A40 and A50 engines are fitted with a Zenith downdraught carburetter. It has an accelerator pump and economy device to give a brisk performance with low fuel consumption. A straightforward and dependable unit, it requires the minimum of attention to keep it in good trim.

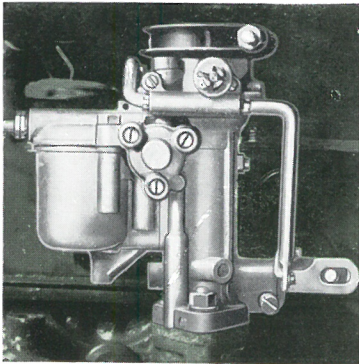

AIR CLEANER

Most cars for export are fitted with an oil bath air cleaner. Dust particles are extracted from the ingoing air by both the oil and the gauze strainer so that only clean air enters the carburetter. A simplified gauze-type air cleaner is supplied for territories where bad dust conditions are not usually met.

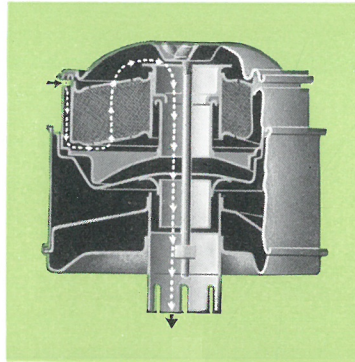

PETROL PUMP

Petrol is drawn from a tank located behind the rear seat by a mechanical pump fitted with a stop tap.

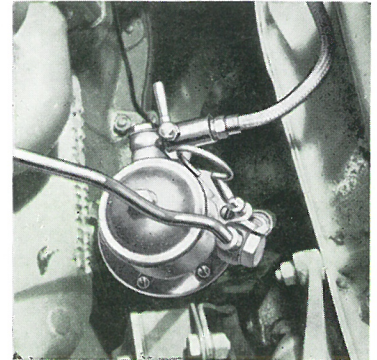

TRANSMISSION

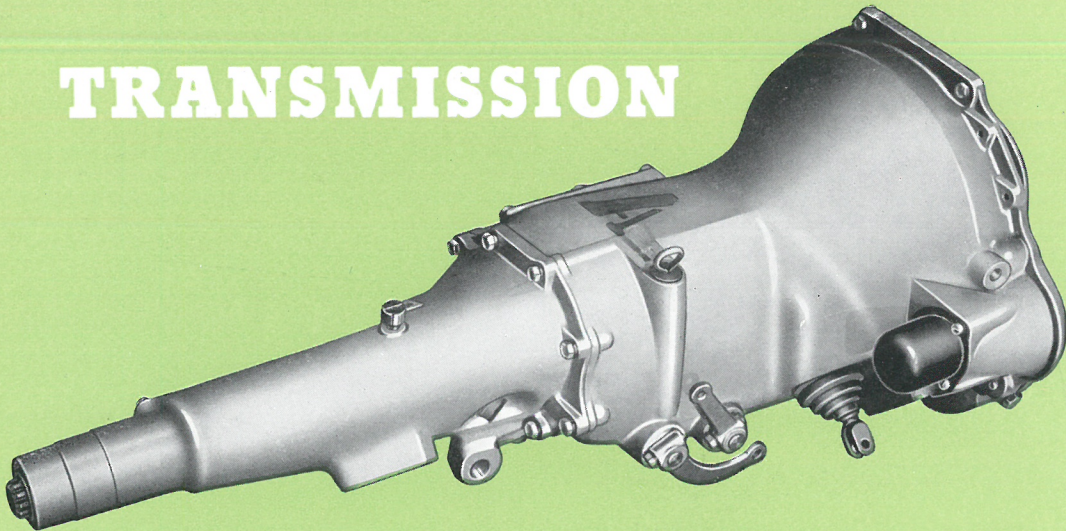

FOUR-SPEED GEARBOX

Synchromesh engagement is provided for second, third and top speeds of the four-speed gearbox. Special baulk rings fitted to the gears make for easy, direct changes of speed. The gearbox is extended at the rear to provide extra support and permit the use of a short propeller shaft, thus assisting the smooth transmission of power.

GEAR CARRIER

Crown wheel, pinion and differential gears are mounted in a detachable carrier. This compact form of assembly enables the gears to be removed as a unit without dismantling the complete rear axle.

CROWN WHEEL AND PINION

Final drive gears are of hypoid design in which the pinion is mounted below the centre line of the crown wheel. This reduces the height of the transmission and permits the use of a lower body floor.

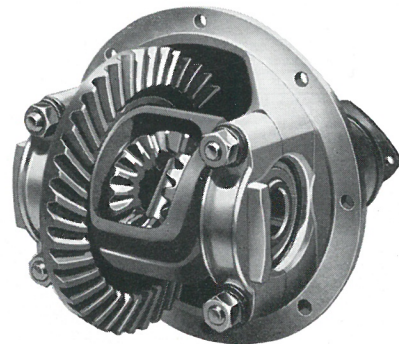
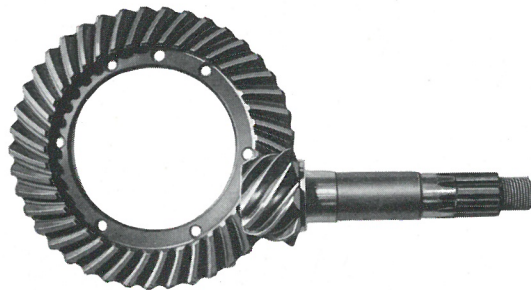

SUSPENSION

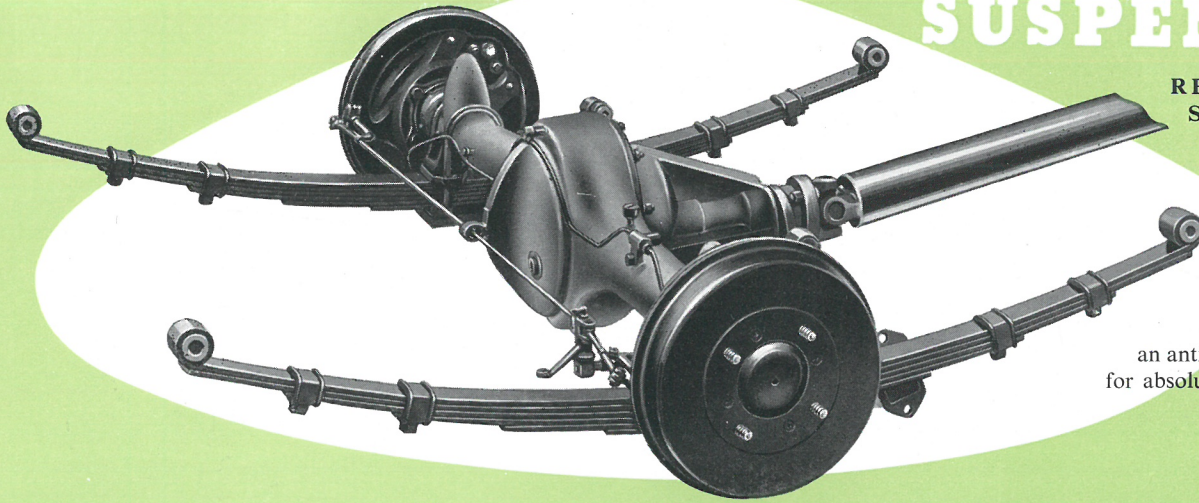

REAR SUSPENSION

At the rear, long semi-elliptical springs are underslung and controlled by double-acting hydraulic shock absorbers. They are interconnected by an anti-sway bar which makes for absolute stability on corners.

BRAKING

FRONT SUSPENSION

Independent coil spring front suspension is employed on the Cambridge to give exceptionally smooth riding. The wishbone-type suspension arms are mounted on rubber bushes and the springs are well controlled by double-acting hydraulic shock absorbers.

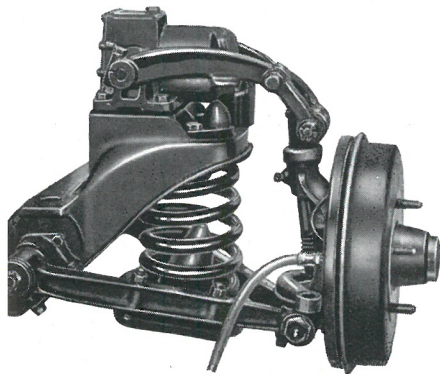

HYDRAULIC BRAKES

The large-diameter hydraulic brakes provide smooth, safe and powerful retardation. Front brakes are of two-leading-shoe design.

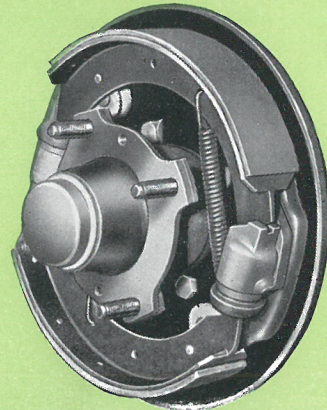

MAJOR UNIT ASSEMBLY

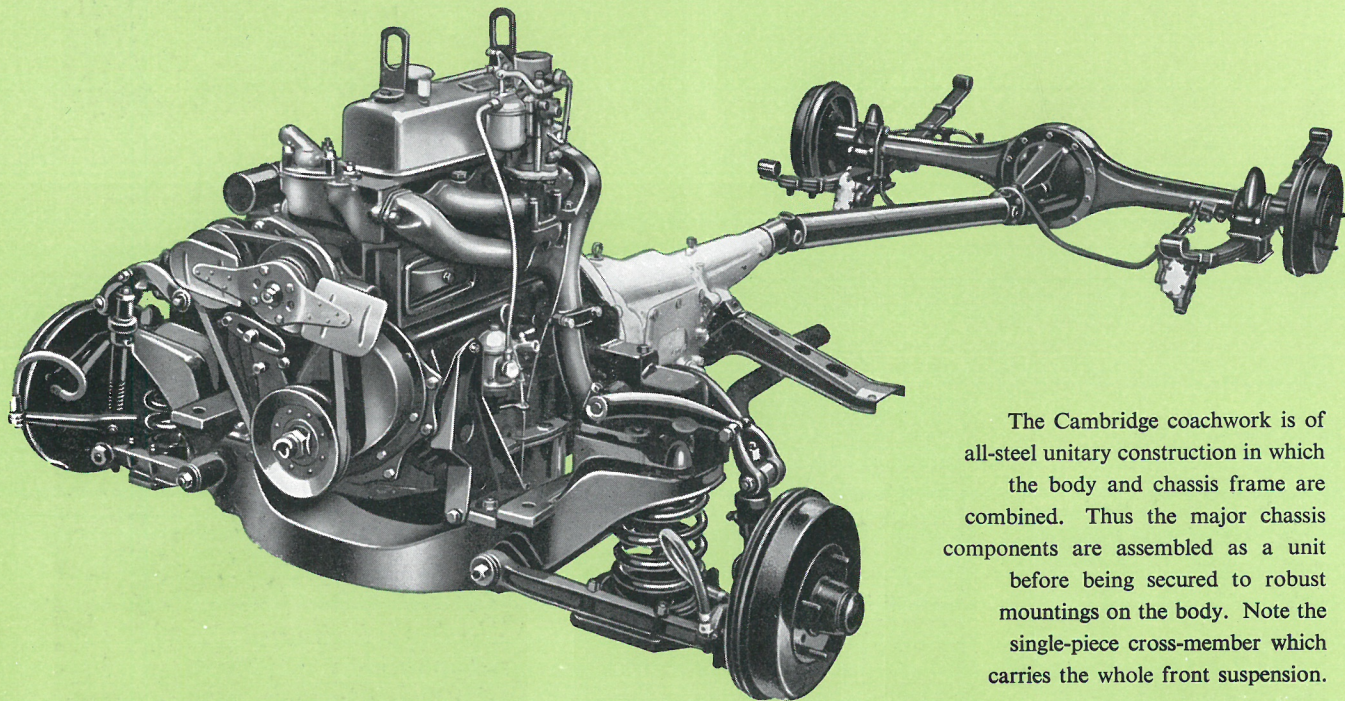

The Cambridge coachwork is of all-steel unitary construction in which the body and chassis frame are combined. Thus the major chassis components are assembled as a unit before being secured to robust mountings on the body. Note the single-piece cross-member which carries the whole front suspension.

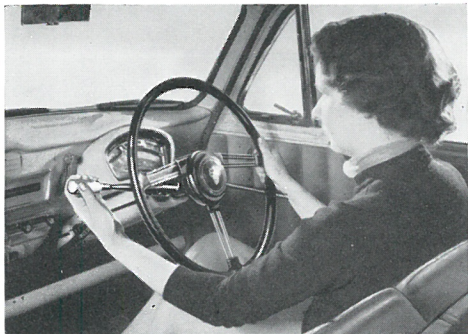

SENSIBLE AND HANDY CONTROLS

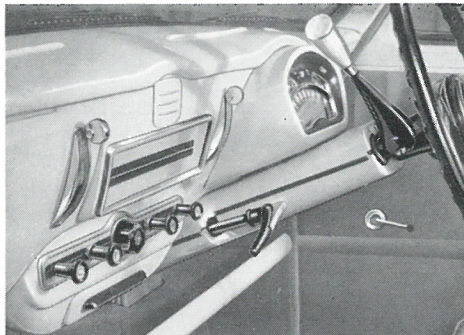

GEAR CHANGE

A well-placed control on the steering column makes gear changing a very simple operation. All connecting linkage consists of rods, no cables are used.

The pistol-grip handbrake is neatly housed in the steering column cover. It applies mechanical brakes on the rear wheels.

HANDBRAKE

GEAR POSITIONS

Attractively designed in transparent plastic material, the knob of the gear lever clearly indicates the change speed positions.

Pendant pedals are conveniently positioned. The clutch is hydraulically operated, oil absorbing all engine movement and automatically taking up wear.

PENDANT PEDALS

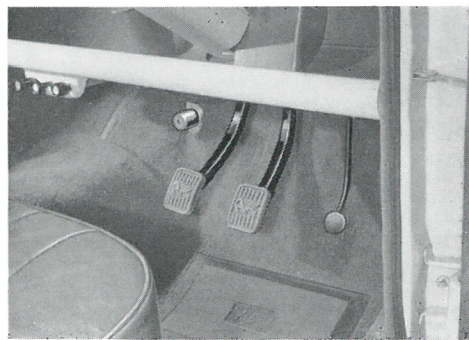
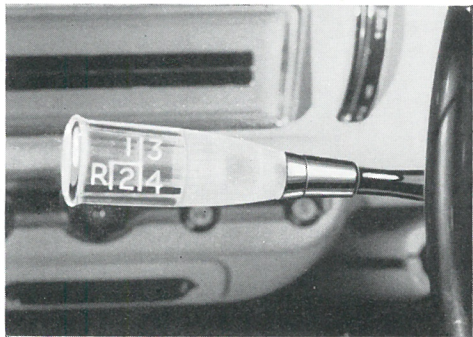

LIGHTING

12-VOLT BATTERY

A 12-volt battery of 38 ampere-hour capacity is fitted in an accessible position under the bonnet.

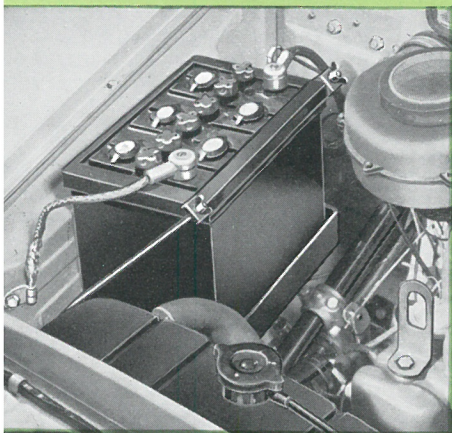

FRONT LIGHTS

Headlights and flashing direction indicators are built into the front wings. Sidelights are mounted on top of the wings where they are visible to the driver.



REAR LIGHTS

At the rear, combined stop-tail lights and amber flashing direction indicators give fair warning to following traffic. There is a separate number-plate light.

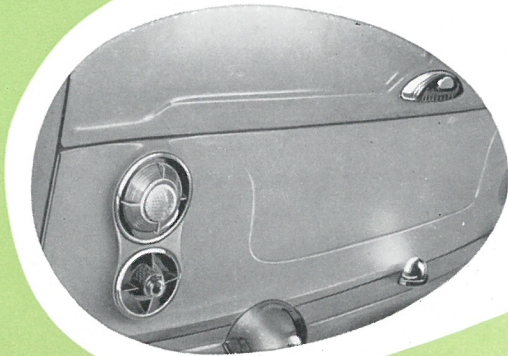



1



2



3

COURTESY LIGHT SWITCH

- 1 A switch, controlled by the opening and closing of the front doors, automatically operates the car interior roof light. The light can also be operated manually.

DIRECTION INDICATOR CONTROL

- 2 Amber flashing indicator lights are controlled by a neat self-cancelling finger lever incorporating a built-in warning-light.

CLEARLY VISIBLE INSTRUMENTS

- 3 Placed directly in front of the driver and visible through the steering wheel is the speedometer which also incorporates the fuel gauge, water temperature indicator and warning lights to show low oil pressure, no dynamo charge and headlamp beam position.

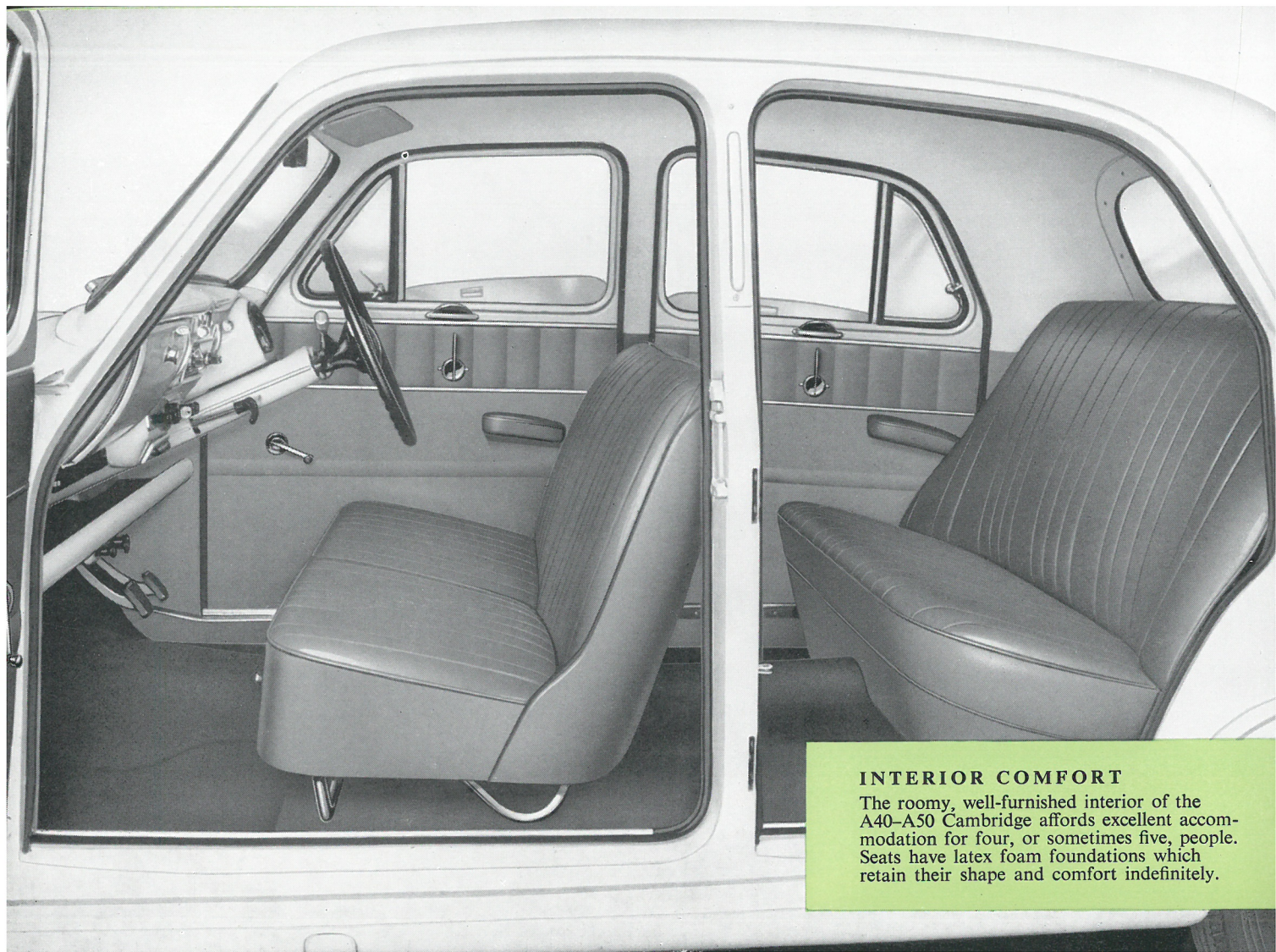

INTERIOR COMFORT

The roomy, well-furnished interior of the A40-A50 Cambridge affords excellent accommodation for four, or sometimes five, people. Seats have latex foam foundations which retain their shape and comfort indefinitely.



GLOVE BOX

A useful glove box is provided in the passenger side of the fascia. The lid, when open, is held in the horizontal position and may be used as a table.

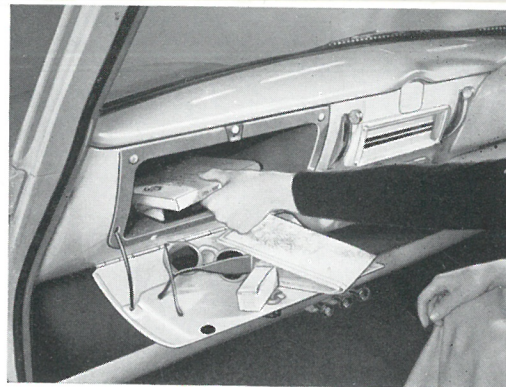

BONNET RELEASE

The bonnet release is operated from inside the car. The control knob is inconspicuous yet accessible when required.

FASCIA FEATURES

An attractively designed dash faces the driver of the Cambridge. Instruments and controls are sensibly positioned for maximum convenience, and the deep parcel shelf, which runs the full width of the car beneath the fascia, provides admirable storage space for handbags, parcels and the many incidental items carried by the motorist. The steering column is neatly encased in a metal cover and the spring-spoke steering wheel is 17 in. in diameter.

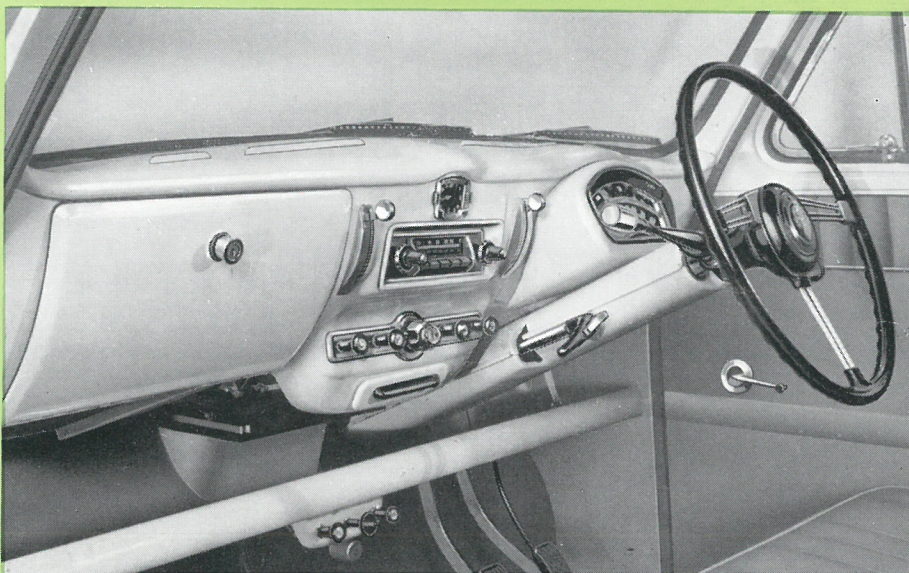

FRONT VENTILATING LOUVRES

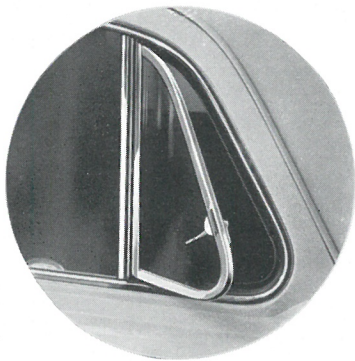
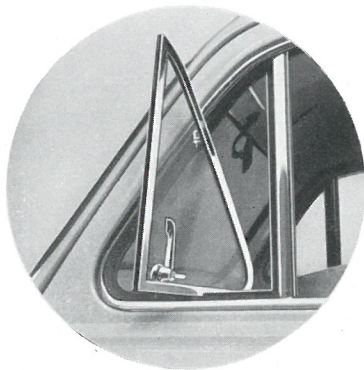

REAR VENTILATING LOUVRES

WINDOWS



Fine visibility and ample ventilation are afforded by the large door windows. Altogether there is nearly half a hundredweight of glass in the Cambridge, covering an area of more than 17 square feet. All the glass is toughened for safety and the windows can be quickly raised or lowered. Swivelling friction-controlled ventilating louvres are fitted to both front and rear doors to provide draught-free ventilation or a flow of fresh air into the car.

DRIVING VISION

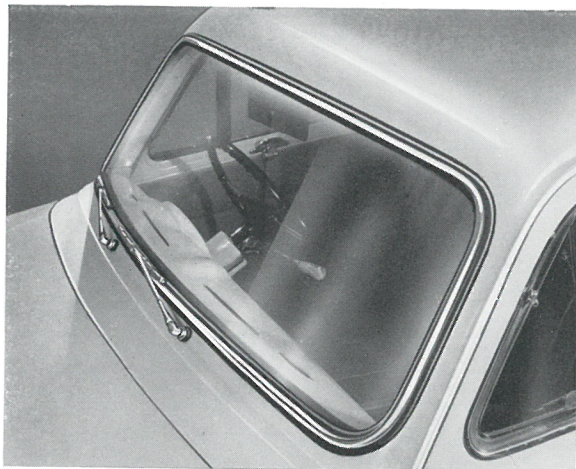

The driver has an exceptionally wide range of vision through the toughened curved glass windscreen. It is deep, too, to give an excellent view of the road ahead. Even in wet weather clear visibility is assured by the wide sweep of the dual, electric windscreen wipers which are self-parking.

REAR VIEW

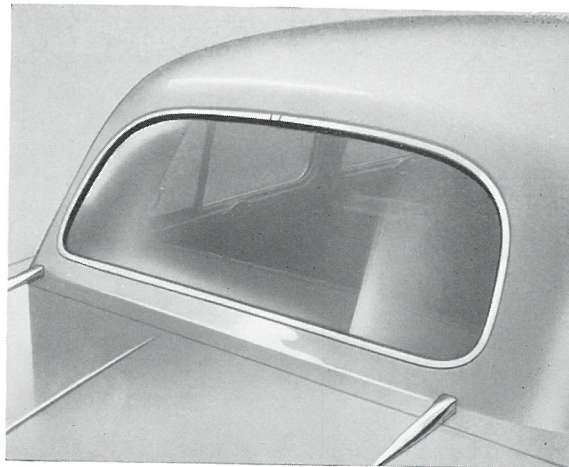

Completing the all-round visibility of the Cambridge is the large-area rear window through which can be gained a comprehensive view of the road behind the car. Manœuvring in reverse is made easy and following traffic can be safely kept in sight.

DOOR HANDLES

Door handles are of the push-button type. A recess in the door behind the handle affords ample room for the fingers.

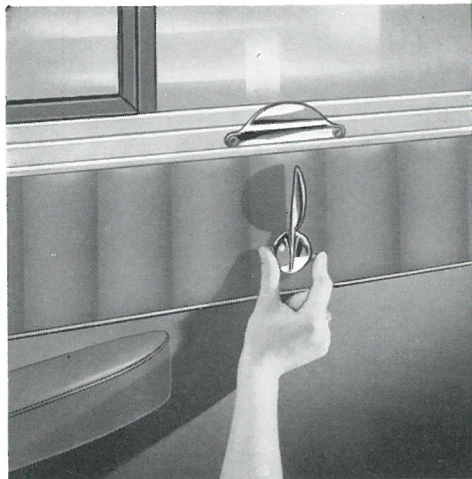

SAFETY CATCH

A special safety catch inside the rear doors prevents their inadvertent opening by children. The doors may still be opened from the outside.

ARM-RESTS

On De Luxe saloons side arm-rests are fitted to the door casings. They are unobtrusively placed yet convenient to use.

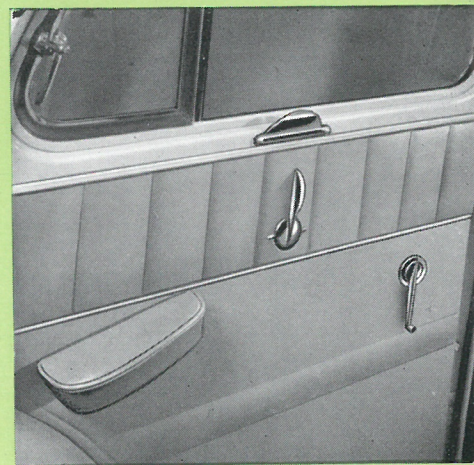

WIDE-OPENING DOORS

Getting in and out through the wide doors of the Cambridge is a simple matter for young and old. All doors are forward-hinged for safety and open to a wide angle.



SEAT ADJUSTMENT

Front seats are individually adjustable to one of three set positions.

These positions are carefully graded to give maximum comfort to every size of driver, and the adjustment is quickly effected.



REAR SEATING

The rear seat, being positioned forward of the wheel arches, is completely unobstructed and extends the full width of the car. There is spacious accommodation for two passengers and occasional seating for three.



LUGGAGE COMPARTMENT

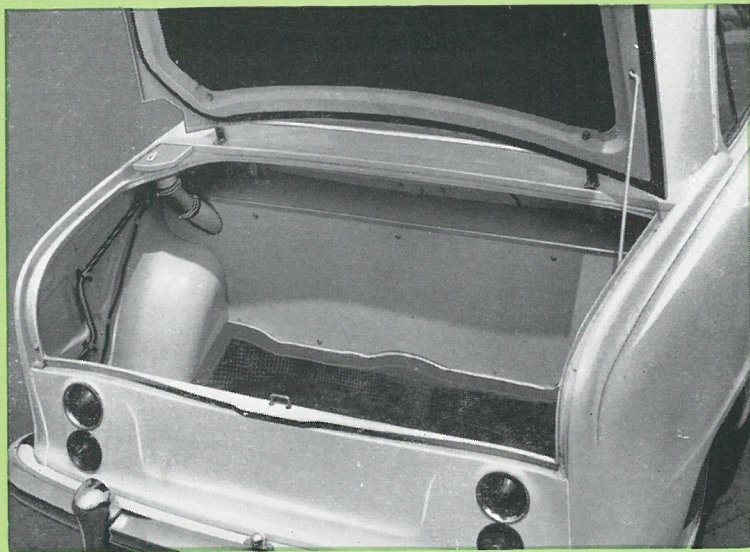

With a capacity of approximately 14 cubic feet the Cambridge boot has room for a vast amount of luggage and sporting equipment. A shelf at the back of the boot provides useful stowage for tools, tyre pump, washing sponge and similar items that would otherwise occupy floor space. The wheelbrace/starting handle and jack are held in special clips at the sides.

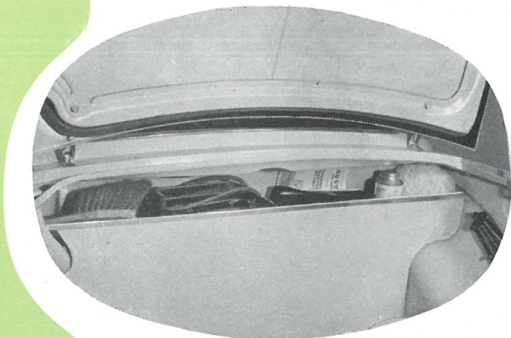

REAR SHELF

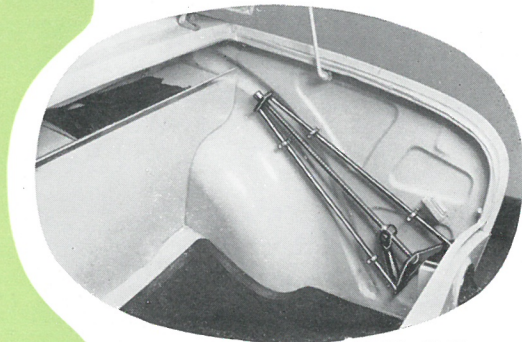

JACK CLIP

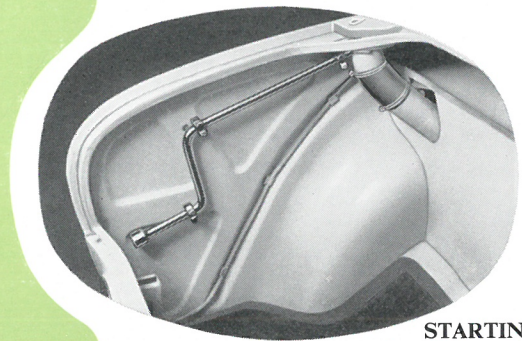

STARTING
HANDLE CLIP

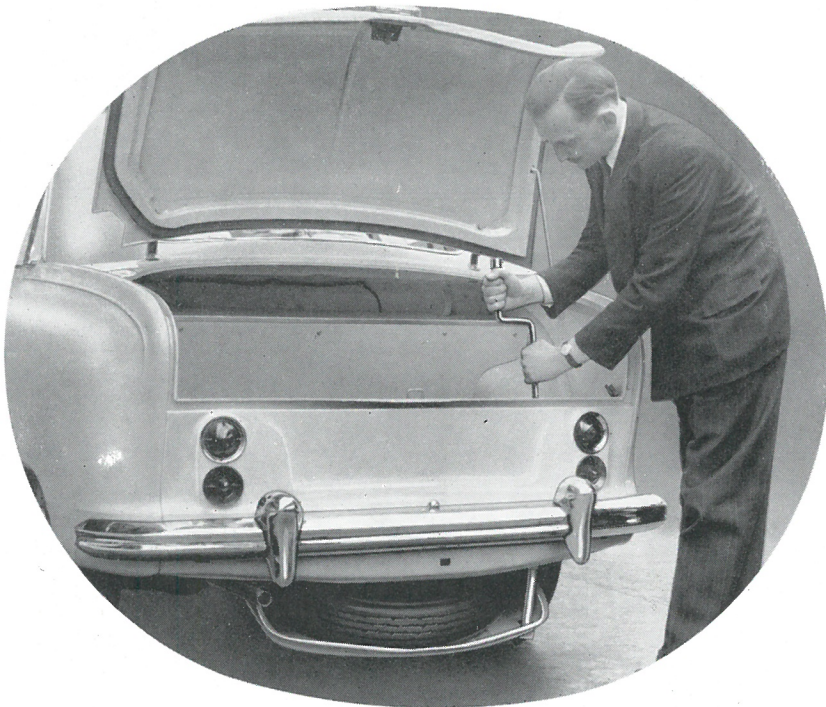

SPARE WHEEL CARRIER

The spare wheel is carried in a special tray beneath the boot. It is quickly and easily lowered without disturbing luggage by means of the starting handle, and just as easily raised by the same method.

JACKING

Jacking the car causes no problems. The triangular jack fits into a bracket in the body side and lifts one side of the car at a time. The bracket is protected by a metal cover when not in use.

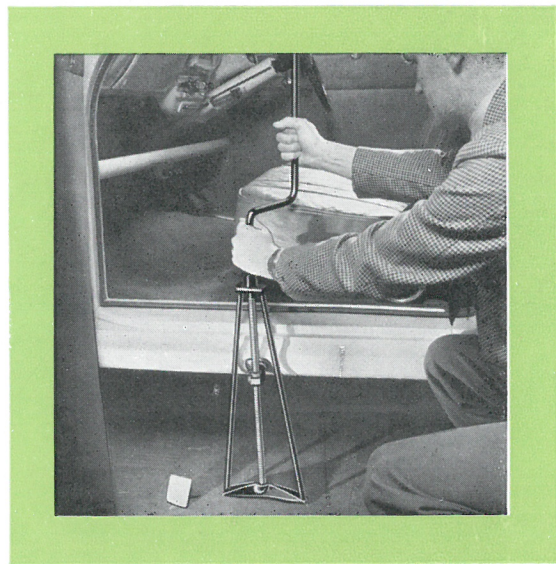

AIR INTAKE

The intake for the air conditioning, heating and windscreen demisting system is located in the forward end of the bonnet. In this position it receives maximum air pressure and is above the level of fumes from the exhausts of other cars.

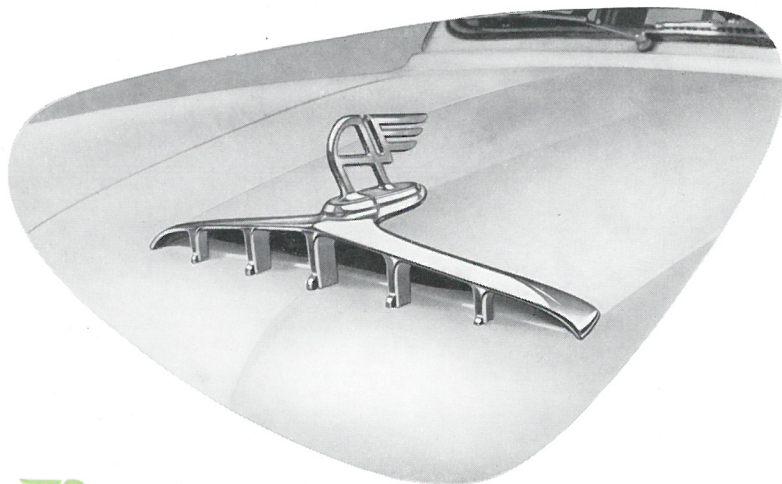

AIR CONDITIONING AND HEATING

Fresh air flows through the intake and along a duct built into the under side of the bonnet. It may then pass directly into the car as cold air (green arrows) or by way of the heater as hot air to warm the interior and demist the windscreen (black arrows). Controls on the dash regulate the flow of both hot and cold air as required.

ACCESSORIES



RADIO AND CLOCK

A radio may be installed as an optional extra. Provision is made in the fascia for the control unit which fits snugly in position and is convenient to regulate. A clock is also available as an optional extra, a place being allotted for it above the radio.

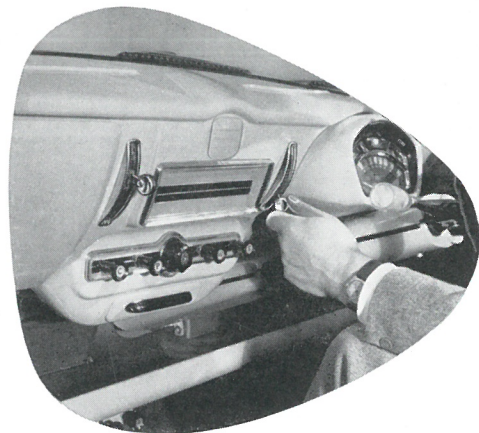

HEATER CONTROLS

The controls for air conditioning, heating and windscreen demisting are neat and accessible.

ASHTRAY

A sensibly designed, drawer-type ashtray is fitted at the bottom of the dash.

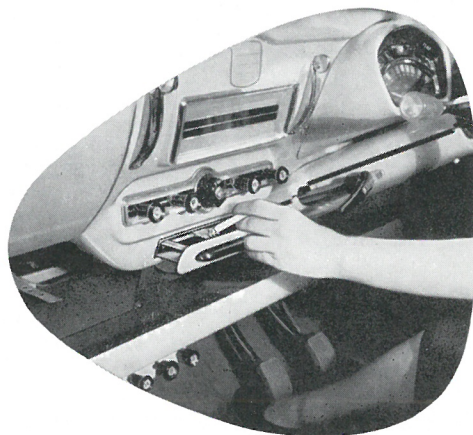



S P E C I F I C A T I O N S

ENGINE: A40—1200 c.c. (73·17 cu. in.); bore 2·578 in. (65·48 mm.); stroke 3·5 in. (89 mm.); b.h.p. 42 at 4,500 r.p.m.; maximum torque 58 lb./ft. at 2,400 r.p.m.; compression ratio 7·2 to 1.

A50—1500 c.c. (91·46 cu. in.); bore 2·875 in. (73·025 mm.); stroke 3·5 in. (89 mm.); b.h.p. 47 at 4,100 r.p.m.; maximum torque 74 lb./ft. at 2,100 r.p.m.; compression ratio 7·2 to 1.

Cylinders: Four cylinders cast integral with crankcase. Detachable cast-iron head carrying valve gear.

Crankshaft: Forged steel supported by three steel-backed white metal bearings.

Connecting Rods: Forged steel with steel-backed white metal bearings.

Pistons: Split-skirt, concave-top pistons in aluminium alloy with alumilite finish. Three compression rings and one slotted oil control ring fitted.

Camshaft: Forged steel in three steel-backed white metal bearings. Cams of patented design to give efficient and quiet operation. The camshaft gear has special oil catchers and a tensioner ring to maintain chain lubrication and tightness respectively.

Valves: Overhead, operated by push-rods and designed for silent operation. Valve oil seals are fitted.

Lubrication: Oil is forced under pressure to all main, connecting rod and camshaft bearings and to each tappet. It is also fed to the timing chain and overhead valve rocker gear. The connecting rods have jet holes to provide oil for cylinder walls when starting up. Both main and connecting rod oil feeds are of patented design to ensure longer crankshaft life. A by-pass oil filter is fitted. Oil capacity approximately 7 pints (3·976 litres).

Cooling: Circulation by centrifugal pump with thermostat control. Water is delivered to the cylinder block and thence to ample passages surrounding valve pockets and sparking plugs. A four-bladed fan is fitted to export models. Cooling system capacity approximately 12 pints (6·8 litres).

Ignition: Coil and 12-volt battery ignition with automatic advance and retard and built-in vacuum control.

Fuel System: Fuel from a rear tank is fed by mechanical pump to the Zenith down-draught carburetter fitted with "T" type air cleaner. An oil bath air cleaner is fitted to some export models. A stop-tap is provided in the fuel line. Tank capacity 8¾ gallons (37 litres).

CLUTCH: Borg and Beck single dry plate, 7¼ in. (0·18 m.) diameter for A40, 8 in. (0·20 m.) diameter for A50. The clutch is operated hydraulically by pendant pedal.

GEARBOX: Four-speed gearbox, with synchromesh engagement for all gears except bottom and reverse. The change speed lever is mounted on the steering column. Oil capacity approximately 4½ pints (2.55 litres).

REAR AXLE: Hypoid bevel drive in pressed steel “banjo” type casing. Ratios: A40, 5.125 to 1; A50, 4.875 to 1. Oil capacity approximately 2 pints (1.14 litres).

OVERALL GEAR RATIOS: A40—5.125, 7.64, 12.31, 20.22 with 26.4 reverse. **A50—**4.875, 7.26, 11.71, 19.23 with 25.15 reverse.

ROAD SPEEDS AT 1,000 R.P.M. : A40—Top 14.28 m.p.h.; third 9.58 m.p.h.; second 5.94 m.p.h.; first 3.29 m.p.h. **A50—**Top 15.01 m.p.h.; third 10.07 m.p.h.; second 6.25 m.p.h.; first 3.80 m.p.h.

STEERING: Special high-efficiency cam type. Spring-spoke 17 in. (0.43 m.) diameter steering wheel with central horn button.

SUSPENSION: Front—Independent coil springs controlled by double-acting hydraulic shock absorbers. **Rear—**Long semi-elliptic reverse camber springs, under-slung and mounted on rubber bushes. Control by double-acting hydraulic shock absorbers interconnected by stabilising bar.

BRAKES: Girling hydraulic on all wheels, applied by pendant pedal. Front brakes are of two-leading-shoe design. A pistol-grip handbrake housed in the steering column cover operates mechanically on the rear wheels.

WHEELS and TYRES: Pressed steel disc wheels with slots for ventilation and the fitting of non-skid chains. Large chromium-plated discs. Dunlop 5.60—15 tubeless tyres.

ELECTRICAL: 12-volt, 38 ampere hour capacity battery: built-in headlamps with block lenses, and dipping equipment to suit regulations of different countries; separate sidelamps on top of wings, visible to driver; twin combined stop-tail lights with built-in reflectors; rear number-plate lamp; interior roof light operated manually, and automatically by the opening and closing of the front doors; amber flashing direction indicators operated by self-cancelling finger lever on steering column, with built-in warning light; dual wind-screen wipers.

INSTRUMENTS: Trip and total mileage speedometer which also incorporates the fuel gauge and water temperature indicator, and indicator lights to show low oil pressure, no dynamo charge and headlamp beam position.

COACHWORK: Four-door, four/five-seater, sound-insulated saloon of all-steel unitary construction with fully-stressed skin and no soldered joints. Rear-opening doors with toughened glass windows and friction-controlled ventilating louvres. Rear doors have additional safety catch to prevent their inadvertent opening by children. Windscreen of toughened curved glass. Individually adjustable front seats; all seats have latex foam moulded foundations. Large capacity luggage compartment with separate spare wheel carrier beneath; spare wheel is lowered by means of starting handle. Attractive fascia with glove box on passenger side and full-width parcel shelf. Bonnet lock controlled from inside car. Air conditioning provided for interior.

Standard 4-door Models: Seats trimmed in P.V.C.-coated fabric; floor covered with rubber mat at front, carpet at rear; single sun visor fitted; single horn. **Optional Extras:** Heater, radio, electric clock.

De Luxe 4-door Models: Heater; seat contact surfaces of hide, remainder of trim in P.V.C.-coated fabric, carpets front and rear; side arm-rests, fitted to door casings; twin sun visors; locking glove box lid; twin horns; chromium mouldings; bumper overriders. **Optional Extras:** Radio, electric clock.

LEADING
DIMENSIONS

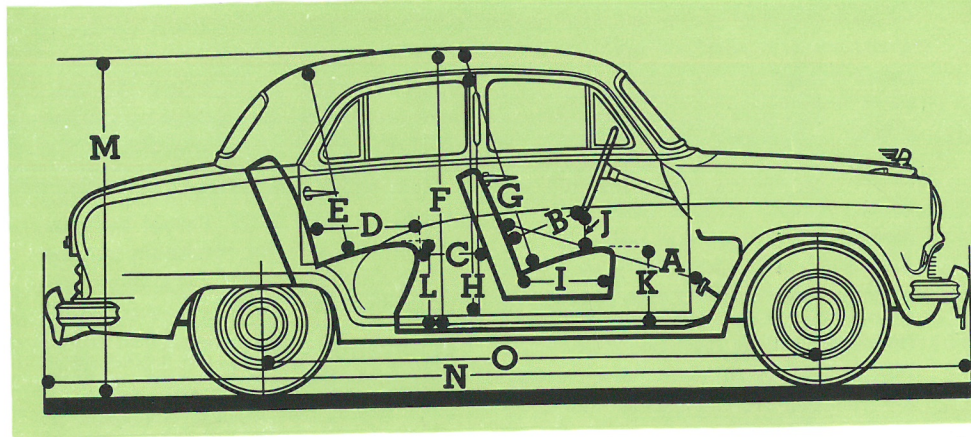

	inches	metres
Pedal to Seat Squab	A { 36½	0.93
	32½	0.83
Steering Wheel to Seat Squab	B { 16¾	0.43
	12¾	0.32
Distance between Seats	C { 12¾	0.32
	8½	0.22
Rear Seat Cushion Depth	D 18	0.46
Height over Rear Seat	E 35	0.89
Maximum Interior Height	F 48½	1.22
Height over Front Seat	G 37	0.94
Minimum Height of Door Opening	H 39½	1.00
Front Seat Cushion Depth	I 17½	0.44
Steering Wheel to Seat Cushion ..	J 6	0.15

	inches	metres
Front Seat Cushion above Floor ..	K 14	0.36
Rear Seat Cushion above Floor ..	L 15	0.38
Overall Height (unladen) ..	M 61½	1.55
Overall Length ..	N 162½	4.11
Wheelbase ..	O 99½	2.51
Overall Width ..	61½	1.55
Body Width between Centre Pillars (at waist)	49¾	1.26
Front Seat Cushion Width (maximum)	24	0.61
Rear Seat Cushion Width (maximum)	52	1.32
Maximum Width over Rear Seat	52	1.32

	inches	metres
Track, front at ground level	48½	1.22
Track, rear	49	1.24
Ground Clearance ..	7	0.18
Turning Circle	36 ft.	11.00
Luggage Compartment—Height of Opening ..	23	0.58
Luggage Compartment—Width of Opening ..	46¾	1.18
Luggage Compartment—Maximum Depth ..	26¼	0.67
Luggage Compartment—Approx. Capacity ..	14 cu.ft.	0.40 cu. m.
Approximate Weight—Less Fuel	2240 lb.	1016 kg.

The goods manufactured by The Austin Motor Company Limited are supplied with an express Warranty which excludes all warranties, conditions and liabilities whatsoever implied by Common Law, Statute or otherwise.

PRICES.—The Company reserves the right to vary the list prices at any time.

SPECIFICATION.—The Company reserves the right on the sale of any vehicle to make before delivery without notice any alteration to or departure from the specification, design or equipment detailed in this publication. Under present supply difficulties such alterations are likely to occur at any time.

THE AUSTIN MOTOR COMPANY LIMITED

LONGBRIDGE BIRMINGHAM

AUSTIN MOTOR EXPORT CORPORATION LIMITED

LONGBRIDGE . BIRMINGHAM . ENGLAND